

MS2650/MS2660B/C Series
Spectrum Analyzer
Operation Manual
Vol. 1
(Basic Operating Instructions)

Eighth Edition

**Read this manual before using the equipment.
Keep this manual with the equipment.**

Measurement Solutions
ANRITSU CORPORATION

JUL.
2001

Document No.: M-W1251AE-8.0

Safety Symbols

To prevent the risk of personal injury or loss related to equipment malfunction, Anritsu Corporation uses the following safety symbols to indicate safety-related information. Insure that you clearly understand the meanings of the symbols BEFORE using the equipment.

Symbols used in manual

DANGER 

This indicates a very dangerous procedure that could result in serious injury or death if not performed properly.

WARNING 

This indicates a hazardous procedure that could result in serious injury or death if not performed properly.

CAUTION 

This indicates a hazardous procedure or danger that could result in light-to-severe injury, or loss related to equipment malfunction, if proper precautions are not taken.

Safety Symbols Used on Equipment and in Manual

(Some or all of the following five symbols may not be used on all Anritsu equipment. In addition, there may be other labels attached to products which are not shown in the diagrams in this manual.)

The following safety symbols are used inside or on the equipment near operation locations to provide information about safety items and operation precautions. Insure that you clearly understand the meanings of the symbols and take the necessary precautions BEFORE using the equipment.



This indicates a prohibited operation. The prohibited operation is indicated symbolically in or near the barred circle.



This indicates an obligatory safety precaution. The obligatory operation is indicated symbolically in or near the circle.



This indicates warning or caution. The contents are indicated symbolically in or near the triangle.



This indicates a note. The contents are described in the box.



These indicate that the marked part should be recycled.

MS2650/MS2660B/C Series Spectrum Analyzer
Operation Manual Vol. 1 (Basic Operating Instructions)

14 March 1997 (First Edition)
16 March 2001 (Eighth Edition)

Copyright © 1997-2001, ANRITSU CORPORATION.

All rights reserved. No part of this manual may be reproduced without the prior written permission of the publisher.

The contents of this manual may be changed without prior notice.

Printed in Japan

APPENDIXES

TABLE OF CONTENTS

APPENDIX A	FRONT AND REAR PANEL LAYOUT	A-1
APPENDIX B	BLOCK DIAGRAM	B-1
APPENDIX C	PERFORMANCE TEST RECORD	C-1

APPENDIX A

FRONT AND REAR PANEL LAYOUT

This appendix shows the front and rear panel layout.

Fig. NO.	Name
Fig. A-1.	MS2651B Front Panel
Fig. A-2	MS2651B (with Opt.22, 23) Front Panel
Fig. A-3	MS2653B Front Panel
Fig. A-4	MS2661B Front Panel
Fig. A-5	MS2661B (with Opt.22, 23) Front Panel
Fig. A-6	MS2663B Front Panel
Fig. A-7	MS2651B/2661B/2653B/2663B Rear Panel
Fig. A-8	MS2651B/2661B/2653B/2663B (with Opt.14) Rear Panel
Fig. A-9	MS2661C Front Panel
Fig. A-10	MS2661C (with Opt.22, 23) Front Panel
Fig. A-11	MS2663C Front Panel
Fig. A-12	MS2661C/2663C Rear Panel
Fig. A-13	MS2661C/2663C (with Opt.14) Rear Panel

For Safety

WARNING



1. ALWAYS refer to the operation manual when working near locations at which the alert mark shown on the left is attached. If the operation, etc., is performed without heeding the advice in the operation manual, there is a risk of personal injury. In addition, the equipment performance may be reduced.

Moreover, this alert mark is sometimes used with other marks and descriptions indicating other dangers.



2. When supplying power to this equipment, connect the accessory 3-pin power cord to a 3-pin grounded power outlet. If a grounded 3-pin outlet is not available, before supplying power to the equipment, use a conversion adapter and ground the green wire, or connect the frame ground on the rear panel of the equipment to ground. If power is supplied without grounding the equipment, there is a risk of receiving a severe or fatal electric shock. In addition, there is a risk of damage to internal circuits of this equipment.

Repair

WARNING 

3. This equipment cannot be repaired by the user. DO NOT attempt to open the cabinet or to disassemble internal parts. Only Anritsu-trained service personnel or staff from your sales representative with a knowledge of electrical fire and shock hazards should service this equipment. There are high-voltage parts in this equipment presenting a risk of severe injury or fatal electric shock to untrained personnel. In addition, there is a risk of damage to precision parts.

Falling Over

4. This equipment should be used in the correct position. If the cabinet is turned on its side, etc., it will be unstable and may be damaged if it falls over as a result of receiving a slight mechanical shock.
-

For Safety

WARNING

LCD

5. This instrument uses a Liquid Crystal Display (LCD);
DO NOT subject the instrument to excessive force or drop it. If the LCD is subjected to strong mechanical shock, it may break and liquid may leak.
This liquid is very caustic and poisonous.
DO NOT touch it, ingest it, or get in your eyes. If it is ingested accidentally, spit it out immediately, rinse your mouth with water and seek medical help. If it enters your eyes accidentally, do not rub your eyes, irrigate them with clean running water and seek medical help. If the liquid gets on your skin or clothes, wash it off carefully and thoroughly.

Battery fluid

6. DO NOT short the battery terminals and never attempt to disassemble it or dispose of it in a fire. If the battery is damaged by any of these actions, the battery fluid may leak.
This fluid is poisonous.
DO NOT touch it, ingest it, or get in your eyes. If it is accidentally ingested, spit it out immediately, rinse your mouth with water and seek medical help. If it enters your eyes accidentally, do not rub your eyes, irrigate them with clean running water and seek medical help. If the liquid gets on your skin or clothes, wash it off carefully and thoroughly.
-

For Safety

CAUTION

Changing Fuse

CAUTION

1. Before changing the fuses, ALWAYS remove the power cord from the power outlet and replace the blown fuses. ALWAYS use new fuses of the type and rating specified on the fuse marking on the rear panel of the cabinet.

T5A indicates a time-lag fuse.

There is risk of receiving a fatal electric shock if the fuses are replaced with the power cord connected.

Cleaning

2. Keep the power inlet and cooling fan free of dust.
 - Clean the power inlet regularly. If dust accumulates around the power pins, there is a risk of fire.
 - Keep the cooling fan clean so that the ventilation holes are not obstructed. If the ventilation is obstructed, the cabinet may overheat and catch fire.

Input Level



3. ◆MS2651B/2661B/2661C (standard:50Ω)
 - Maximum DC voltage ratings:
 - RF Input ±DC 50 V
 - TG Output ±DC 0 V
 - Maximum AC power (continuous wave) ratings:
 - RF Input +30 dBm (RF ATT ≥10 dB)
 - TG Output +20 dBm

NEVER input a over maximum ratings to RF Input and TG Output, excessive power may damage the internal circuits.

◆MS2651B/2661B/2661C (plus opt. 08 preamplifier ON)

- Maximum DC voltage ratings:
 - RF Input ±DC 50 V
- Maximum AC power (continuous wave) ratings:
 - RF Input +10 dBm (RF ATT ≥10 dB)

NEVER input a over maximum ratings to RF Input, excessive power may damage the internal circuits.

For Safety

◆MS2651B/2661B/2661C (plus opt. 19 DC Input)

- Maximum DC voltage ratings:
RF Input \pm DC 0 V
- Maximum AC power (continuous wave) ratings:
RF Input +30 dBm (RF ATT \geq 10 dB)

NEVER input a over maximum ratings to RF Input, excessive power may damage the internal circuits.

◆MS2651B/2661B/2661C (plus opt. 22, 23:75 Ω Input, 75 Ω TG)

- Maximum DC voltage ratings:
RF Input \pm DC 100 V
TG Output \pm DC 0 V
- Maximum AC power (continuous wave) ratings:
RF Input +25 dBm (RF ATT \geq 10 dB)
TG Output +20 dBm

NEVER input a over maximum ratings to RF Input and TG Output, excessive power may damage the internal circuits.

◆MS2653B/2663B/2663C

- Maximum DC voltage ratings:
RF Input \pm DC 0 V
- Maximum AC power (continuous wave) ratings:
RF Input +30 dBm (RF ATT \geq 10 dB)

NEVER input a over maximum ratings to RF Input, excessive power may damage the internal circuits.

◆MS2653B/2663B/2663C (plus opt. 08 preamplifier ON)

- Maximum DC voltage ratings:
RF Input \pm DC 50 V
- Maximum AC power (continuous wave) ratings:
RF Input +10 dBm (RF ATT \geq 10 dB)

NEVER input a over maximum ratings to RF Input, excessive power may damage the internal circuits.

◆RF Input/TG Output connector

- MS2651B/2661B/2661C/2653B/2663B/2663C (standard:50 Ω)
RF Input N-J
TG Output N-J
- MS2651B/2661B/2661C (plus opt. 22, 23:75 Ω)
RF Input NC-J
TG Output NC-J

NEVER connect a difference type connector, Connecting a difference type may damage the connector.

For Safety

CAUTION

Replacing Memory Back-up Battery

4. The power for memory backup is supplied by a Poly-carbonmonofluoride Lithium Battery. This battery should only be replaced by a battery of the same type; since replacement can only be made by Anritsu, contact the nearest Anritsu representative when replacement is required.

Note: The Battery life is about 7 years. Early battery replacement is recommended.

Storage Medium

5. This equipment stores data and programs using Plug-in Memory card (MC).
Data and programs may be lost due to improper use or failure. ANRITSU therefore recommends that you backup the memory.

Anritsu Corporation will not accept liability for lost data.

Please pay careful attention to the following points.

- Do not remove the IC card from equipment being accessed.
- Isolate the card from static electricity.
- The backup battery in the SRAM memory card has a limited life; replace the battery periodically.

Disposing of The Product

6. This equipment uses chemical compound semiconductor including arsenide.
At the end of its life, the equipment should be recycled or disposed properly according to the local disposal regulations.

Equipment Certificate

Anritsu Corporation certifies that this equipment was tested before shipment using calibrated measuring instruments with direct traceability to public testing organizations recognized by national research laboratories including the Electrotechnical Laboratory, the National Research Laboratory of Metrology and the Communications Research laboratory, and was found to meet the published specifications.

Anritsu Warranty

Anritsu Corporation will repair this equipment free-of-charge if a malfunction occurs within 1 year after shipment due to a manufacturing fault, provided that this warranty is rendered void under any or all of the following conditions.

- The fault is outside the scope of the warranty conditions described in the operation manual.
- The fault is due to misoperation, misuse, or unauthorized modification or repair of the equipment by the customer.
- The fault is due to severe usage clearly exceeding normal usage.
- The fault is due to improper or insufficient maintenance by the customer.
- The fault is due to natural disaster including fire, flooding and earthquake, etc.
- The fault is due to use of non-specified peripheral equipment, peripheral parts, consumables, etc.
- The fault is due to use of a non-specified power supply or in a non-specified installation location.

In addition, this warranty is valid only for the original equipment purchaser. It is not transferable if the equipment is resold.

Anritsu Corporation will not accept liability for equipment faults due to unforeseen and unusual circumstances, nor for faults due to mishandling by the customer.

Anritsu Corporation Contact

If this equipment develops a fault, contact the head office of Anritsu Corporation at the address in the operation manual, or your nearest sales or service office listed on the following pages.

Front Panel Power Switch

To prevent malfunction caused by accidental touching, the front power switch of this equipment turns on the power if it is pressed continuously for about one second in the standby state. If the switch is pressed continuously for one second in the power-on state, the equipment enters the standby state.

In the power-on state, if the power plug is removed from the outlet, then reinserted into it, the power will not be turned on. Also, if the line is disconnected due to momentary power supply interruption or power failure, the power will not be turned on (enters the standby state) even if the line is recovered.

This is because this equipment enters the standby state and prevents incorrect data from being acquired when the line has to be disconnected and reconnected.

For example, if the sweep time is 1,000 seconds and data acquisition requires a long time, momentary power supply interruption (power failure) might occur during measurement and the line could be recovered automatically to power-on. In such a case, the equipment may mistake incorrect data for correct data without recognizing the momentary power supply interruption.

If this equipment enters the standby state due to momentary power supply interruption or power failure, check the state of the measuring system and press the front power switch to restore power to this equipment.

Further, if this equipment is built into a system and the system power has to be disconnected then reconnected, the power for this equipment must also be restored by pressing the front power switch.

Consequently, if this equipment is built into remote monitoring systems that use MODEMs, the standby function of this equipment must be modified.

ABOUT DETECTION MODE

This instrument is a spectrum analyzer which uses a digital storage system. The spectrum analyzer makes level measurements in frequency steps obtained by dividing the frequency span by the number of measurement data points (501). This method of measurement cannot detect the signal peak level if the spectrum of a received signal is narrower than these frequency steps.

To resolve this problem, this instrument usually operates in positive peak detection mode and normal detection mode. In the positive peak detection mode, the highest level within the frequency range between the sample points can be held and traced. In the normal detection mode, both the positive peak and the negative peak can be traced.

Positive peak detection mode should be used for almost all measurements including normal signal level measurement, pulsed noise analysis, and others. It is impossible to measure the signal level accurately in sample detection mode or in negative peak detection mode.

Use of sample detection mode is restricted to random noise measurement, occupied frequency bandwidth measurement for analog communication systems, and adjacent-channel leakage power measurement, etc.

Measurement	Item
• Normal signal	POS PEAK
• Random noise	SAMPLE
• Pulsed noise	NORMAL (POSI-NEG)
• Occupied frequency bandwidth, adjacent-channel leakage power	SAMPLE
(for analog communication systems)	
• Occupied frequency bandwidth, adjacent-channel leakage power	POS PEAK or SAMPLE
(for digital communication systems)	

When a detection mode is specified as one of the measurement methods, make the measurement in the specified detection mode.

CE Marking

Anritsu affixes the CE Conformity Marking on the following product (s) in accordance with the Council Directive 93/68/EEC to indicate that they conform with the EMC directive of the European Union (EU).

CE Conformity Marking



1. Product Name/Model Name

Product Name: Spectrum Analyzer
Model Name: MS2651B/MS2661C/MS2663C

2. Applied Directive

EMC: Council Directive 89/336/EEC
LVD: Council Directive 73/23/EEC

3. Applied Standards

EMC:
Emission: EN61326: 1997/A1: 1998 (Class A)
Immunity: EN61326: 1997/A1: 1998 (Annex A)

	Performance Criteria*
IEC61000-4-2 (ESD)	B
IEC61000-4-3 (EMF)	A
IEC61000-4-4 (Burst)	B
IEC61000-4-5 (Surge)	B
IEC61000-4-6 (CRF)	A
IEC61000-4-8 (RPFMF)	A
IEC61000-4-11 (V dip/short)	B

*: Performance Criteria

A: During testing normal performance within the specification limits.

B: During testing, temporary degradation, or loss of function or which is self-recovering.

Harmonic current emissions:

EN61000-3-2: 1995/A2: 1998 (Class A equipment)

LVD:EN61010-1: 1993/A2: 1995 (Installation Category II, Pollution Degree 2)

Anritsu affixes the C-tick marking on the following product (s) in accordance with the regulation to indicate that they conform with the EMC framework of Australia/New Zealand

C-tick marking



1. Product Name/Model Name

Product Name: Spectrum Analyzer

Model Name: MS2651B/MS2661C/MS2663C

2. Applied Standards

EMC:

Emission:

AS/NZS 2064.1/2 (ISM, Group 1, Class A equipment)

Immunity:

AS/NZS 4252.1

*Performance Criteria

IEC61000-4-2 (ESD)	B
IEC61000-4-3 (EMF)	A
IEC61000-4-4 (Burst)	B
IEC61000-4-5 (Surge)	B
IEC61000-4-6 (CRF)	A
IEC61000-4-8 (RPFMF)	A
IEC61000-4-11 (V dip/short)	B

*: Performance Criteria

A: During testing normal performance within the specification limits.

B: During testing, temporary degradation, or loss of function or which is self-recovering.

Power Line Fuse Protection

For safety, Anritsu products have either one or two fuses in the AC power lines as requested by the customer when ordering.

Single fuse: A fuse is inserted in one of the AC power lines.

Double fuse: A fuse is inserted in each of the AC power lines.

Example: An example of the double fuse is shown below:

Fuse Holders

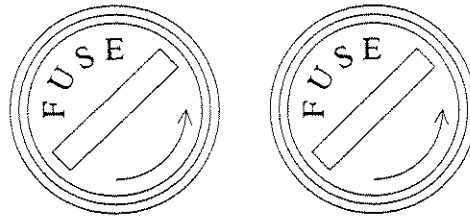

ABOUT THIS MANUAL

(1) Composition of MS2650/MS2660B/C Series Operation Manuals

The MS2650/MS2660B/C series Spectrum Analyzer operation manuals of the standard type are composed of the following three documents. Use them properly according to the usage purpose.

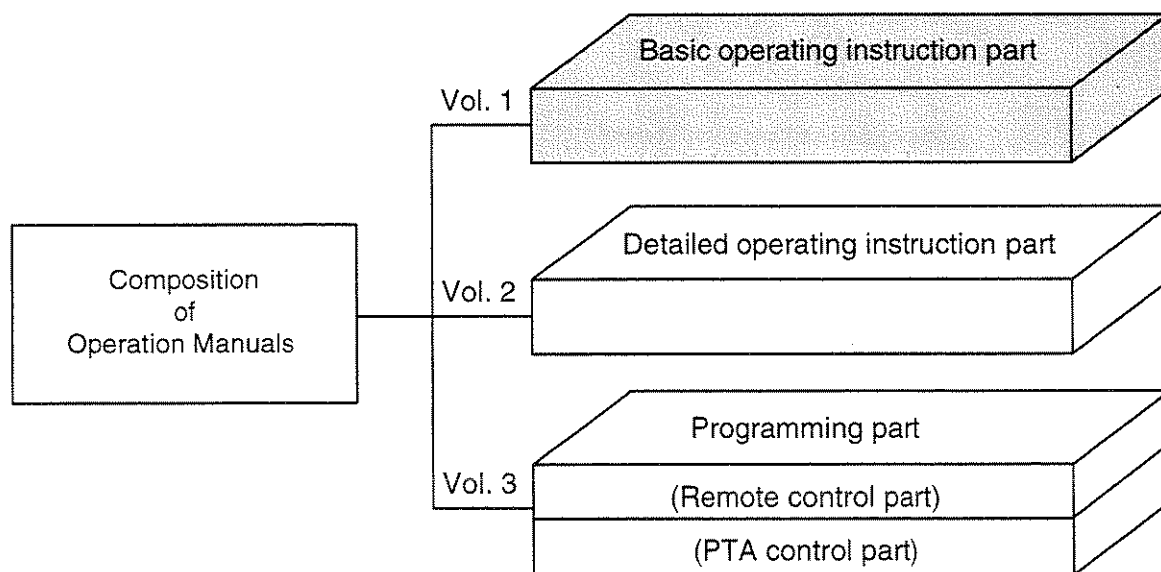

Basic operating instruction part:

Basic Operating Instructions: Provides information on the MS2650/MS2660B/C Series outline, preparation before use, panel description, basic operation, soft-key menu and performance tests.

Detailed operating instruction part:

Detailed Operating Instructions: Provides information on the detailed panel operating instructions on MS2650/MS2660B/C Series that expand on the basic operation and soft-key menu in the Basic Operating Instruction Part.

Programming part:

Composed of the Remote Control Part and PTA Control Part. The Remote Control Part provides information on RS-232C remote control, GPIB remote control and sample programs, while the PTA Control Part describes about PTA operation and PTL commands.

TABLE OF CONTENTS

For Safety	iii
ABOUT THIS MANUAL	I
SECTION 1 GENERAL	1-1
Product Outline	1-3
Composition of Operation Manual	1-4
Equipment Configuration	1-5
Standard configuration	1-5
Options	1-6
Optional Accessories and Peripherals	1-7
Specifications	1-9
SECTION 2 PREPARATIONS BEFORE USE	2-1
Installation Site and Environment Conditions	2-3
Locations to be avoided	2-3
Fan clearance	2-3
Safety Measures	2-4
Power-on	2-4
Input level to RF Input	2-5
Installation	2-6
Rack mounting	2-6
Preparations before Power-on	2-7
Protective grounding	2-8
Replacing fuse	2-9
Precaution for Handling Memory Card	2-11
SECTION 3 PANEL DESCRIPTION	3-1
Table of Front and Rear Panel Features	3-3

SECTION 4	SOFT-KEY MENU	4-1
	Soft-key Menu List	4-4
	Menu Tree	4-6
SECTION 5	BASIC OPERATION PROCEDURE	5-1
	Signal Display	5-3
	Turn the power on	5-3
	Execute automatic calibration	5-4
	Set the signal to the center of the screen	5-4
	Enlarge and display the signal	5-5
	Marker Operation	5-6
	Check of the zone marker function	
	The “marker → CF” function check	
	“Measure” Function Check	5-8
	Screen Hard Copy	5-9
SECTION 6	PERFORMANCE TESTS	6-1
	Requirement for Performance Tests	6-3
	Instruments Required for Performance Test	6-4
	Performance Test	6-6
	Reference oscillator frequency stability	6-6
	Frequency readout accuracy	6-8
	Frequency span readout accuracy	6-11
	Resolution bandwidth (RBW) and selectivity	6-14
	Sideband phase noise	6-20
	Frequency measurement accuracy	6-22
	Amplitude display linearity	6-24
	Frequency response	6-28
	Reference level accuracy	6-31
	Average noise level	6-34
	Second harmonic distortion	6-37
	Resolution bandwidth (RBW) switching error	6-40
	Input attenuator (RF ATT) switching error	6-43
	Sweep time and time span accuracy	6-46
	Tracking generator (TG) output level accuracy	6-50
	Service	6-53

SECTION 7	STORAGE AND TRANSPORTATION	7-1
	Cleaning Cabinet	7-3
	Storage Precautions	7-4
	Precautions before storage	7-4
	Recommended storage precautions	7-4
	Repacking and Transportation	7-5
	Repacking	7-5
	Transportation	7-5
APPENDIX A	FRONT AND REAR PANEL LAYOUT	A-1
APPENDIX B	BLOCK DIAGRAM	B-1
APPENDIX C	PERFORMANCE TEST RECORD	C-1

SECTION 1

GENERAL

This section outlines the MS2650/MS2660B/C Series Spectrum Analyzer and explains the composition of this manual, the configuration of the MS2650/MS2660B/C Series with the standard accessories, the options, the optional accessories, and peripherals for expanding the MS2650/MS2660B/C Series capabilities, and the MS2650/MS2660B/C Series specifications.

TABLE OF CONTENTS

Product Outline	1-3
Composition of Operation Manual	1-4
Equipment Configuration	1-5
Standard configuration	1-5
Options	1-6
Optional Accessories and Peripherals	1-7
Specifications	1-9

SECTION 1 GENERAL

Product Outline

The MS2650/MS2660B/C Series spectrum analyzer (henceforth called "this unit") is a portable type color LCD spectrum analyzer suited for signal analyses of radio equipment where the efficiency of frequency usage is increased and equipment are increasingly speeded and digitized.

Adopts the synthesizer local system and can cover a frequency range of 9 kHz to 3 GHz (when Option 19 DC coupled input is mounted: 500 Hz to 3 GHz, when Option 22 75 Ω input is mounted: 100 kHz to 2.5 GHz) (MS2651B/2661B/2661C), 9 kHz to 8.1 GHz (MS2653B/2663B/2663C).

Excellent in basic performance such as C/N, distortion, frequency/level accuracy, and easily operable following the display of the soft-key menu screen.

Excellent cost performance with rich options to cope with various applications.

Equipped with high-accuracy calibration signals and an attenuator, it can accurately calibrate switching errors of LOG/LIN scales, resolution bandwidth, reference level, etc. Since frequency response is corrected by built-in calibration data, it allows high-accuracy level measurement for a wide range.

As the switching of waveforms between frequency domain and time domain can be done by a touch and two waveforms are simultaneously displayed, signal analyses of both domains can be done efficiently. Moreover, our original zone marker function and multi-marker function (up to 10 markers) are also special mention.

This unit provides the MEASURE function that can perform measurement of various applications without requiring the intervention of external controllers. Therefore, the performance evaluation of radio equipment can be easily done in terms of frequency, noise, occupied frequency bandwidth, leak power from neighboring channels, etc.

In addition, as the template measurement of burst mean power and burst waveform are also available, it is suited for evaluating the performance of digital radio equipment.

■ Application

This unit is useful for the production, building and maintenance of electronic equipment and devices in the following fields.

- AM/FM radio equipment
- Digital cellular telephone/cord-less telephone
- Satellite broadcasting, CATV and TV equipment
- Small-capacity microwave equipment

Because of difference in basic performance such as sideband noise, mean noise level and strain dynamic range, the MS2660B/C series is suited for production and building, and the MS2650B series for maintenance.

Composition of Operation Manual

This Operation Manual is composed of 7 sections and appendixes A, B and C. The profile of each section is shown below.

Section composition	Explanation
SECTION 1 GENERAL	Product outline, standard configuration, options, applicable parts, peripheral devices, and specifications
SECTION 2 PREPARATIONS BEFORE USE	Operations to be done before applying power
SECTION 3 PANEL DESCRIPTION	Description about the front and rear panels
SECTION 4 SOFT-KEY MENU	Description using a soft-key menu
SECTION 5 BASIC OPERATION PROCEDURE	Basic operation procedures for operation guide
SECTION 6 PERFORMANCE TESTS	Tests used for checking performance
SECTION 7 STORAGE AND TRANSPORTATION	Cautions on storage and transportation
APPENDIX A	FRONT AND REAR PANEL LAYOUT
APPENDIX B	BLOCK DIAGRAM
APPENDIX C	PERFORMANCE TEST RECORD

Equipment Configuration

This paragraph describes the configuration of the MS2650/MS2660B/C series Spectrum Analyzer with standard accessories and the various options to expand the functions.

Standard configuration

The table below shows the configuration of the MS2650/MS2660B/C series spectrum analyzer with the standard accessories.

Standard Composition

Item	Model/Order NO.	Name	Qty.	Remarks
Main instrument	MS2651B/MS2661B	Spectrum Analyzer	1	
	MS2653B/MS2663B			
	MS2661C/MS2663C			
Accessories	J0017F	Power cord	1	Approx. 2.5 m
	J0266	Power cord adaptor	1	3-pole to 2-pole conversion
	F0013	Fuse	2	T5 A 250 V
	W1251AE	Operation manual	1	

Options

The table below shows the options for the MS2650/MS2660B/C series which are sold separately.

Model † - Order No. †	Name	Remarks
MS2651B/MS2661B/ MS2653B/MS2663B/ MS2661C/MS2663C-01	Reference crystal oscillator	stability: $\leq 2 \times 10^{-6}$ /day
MS2661B/MS2663B/ MS2661C/MS2663C-02	Narrow resolution bandwidth	30 Hz, 100 Hz, 300 Hz
MS2651B/MS2661B/ MS2653B/MS2663B/ MS2661C/MS2663C-04	High-speed time domain sweep	1.25 μ s/div
MS2651B/MS2661B/ MS2653B/MS2663B/ MS2661C/MS2663C-06	Trigger/Gate circuit	Pre-trigger and post trigger available (Option 16 required for TV trigger)
MS2651B/MS2661B/ MS2653B/MS2663B/ MS2661C/MS2663C-07	AM/FM demodulator (Sound monitor)	Output to loudspeaker or earphone connector
MS2651B/MS2661B/ MS2661C/MS2663C-08	Preamplifier	100 kHz to 3 GHz, Gain=20 dB
MS2651B/MS2661B/ MS2653B/MS2663B/ MS2661C/MS2663C-10	Centronics interface	Not possible when GPIB installed
MS2661B/MS2663B/ MS2661C-12	QP Detector	QP BW=200 Hz, 9 kHz, 120 kHz
MS2651B/MS2653B-13	QP Detector	QP BW=9 kHz, 120 kHz
MS2651B/MS2661B/ MS2653B/MS2663B/ MS2661C/MS2663C-14	PTA Parallel I/O	Controlling external equipment from PTA. Not possible when Option 10 installed
MS2651B/MS2661B/ MS2653B/MS2663B/ MS2661C/MS2663C-15	Sweep signal output	X, Z
MS2651B/MS2661B/ MS2653B/MS2663B/ MS2661C/MS2663C-16	Television monitor	M-NTSC, B/G/H PAL. Option 07 required for audio
MS2661B/MS2661C-19	DC coupled input	Expanding Received frequency to 500 Hz when DC coupled input circuit
MS2651B/MS2661B/ MS26621C-20	Tracking generator	9 kHz to 3 GHz, 0 to -60 dBm
MS2651B/MS2661B/ MS2653B/MS2663B/ MS2661C/MS2663C-21	Television monitor (multi-system)	M-NTSC, B/G/H/I/D PAL. Option 07 required for audio
MS2651B/MS2661B/ MS2661C-22	75 Ω Input	75 Ω , 100 kHz to 2.5 GHz
MS2651B/MS2661B/ MS2661C-23	75 Ω Tracking generator	75 Ω , 100 kHz to 2.5 GHz
MS2651B/MS2661B/ MS2653B/MS2663B/ MS2661C/MS2663C-24	Television monitor (Brazil)	M-NTSC, M PAL. Option 07 required for audio

† Please specify the model/order number, name, and quantity when ordering.

Optional Accessories and Peripherals

The following table shows the optional accessories and peripherals for MS2650/MS2660B series which are all sold separately.

Optional Accesories (1/2)

Model † - Order No. †	Name	Remarks
J0561	Coaxial cord, 1 m	N-P-5W • 5D-2W • N-P-5W
J0104A	Coaxial cord, 1 m	BNC-P • RG-55/U • N-P-5W
CSCJ-256K-SM	256 kB memory card	Meets PCMCIA Ver. 2.0 Type I
CSCJ-512K-SM	512 kB memory card	Meets PCMCIA Ver. 2.0 Type I
CSCJ-001M-SM	1024 kB memory card	Meets PCMCIA Ver. 2.0 Type I
CSCJ-002M-SM	2048 kB memory card	Meets PCMCIA Ver. 2.0 Type I
B0329G	Protective cover	3/4 MW4U
B0395A	Rack mount kit (IEC)	
B0395B	Rack mount kit (JIS)	
J0055	Coaxial adaptor (NC-P • BNC-J)	
J0076	Coaxial adaptor (NC-P • F-J)	
B0391A	Carring case (hard type)	With casters
B0391B	Carring case (hard type)	Without casters
MP612A	RF Fuse Holder	DC to 1000 MHz, 50 Ω (N)
MP613A	Fuse Element	For MP612A
MA8601A	DC Block Adaptor	50 Ω (10 kHz to 2.2 GHz)
MA2507A	DC Block Adaptor	50 Ω (9 kHz to 3.0 GHz)
J0805	DC Block Adaptor	50 Ω (10 kHz to 18 GHz)
MP1621A	50 Ω → 75 Ω Impedance Transformer	9 kHz to 3 GHz, with DC block capacitor (allowable voltage: 100 V)
MP614A	50 Ω ← → 75 Ω Impedance Transformer	10 to 1200 MHz (transformer type)
J0121	Coaxial cord, 1 m	NC-P-3W • 3C-2WS • NC-P-3W
J0308	Coaxial cord, 1 m	BNC-P • 3C-2WS • NC-P-3W
J0063	Fixed attenuator for high power	30 dB (10 W, DC to 12.4 GHz)
J0078	Fixed Foxed Power for high power	20 dB (10 W, DC to 18 GHz)
J0395	Fixed attenuator for high power	30 dB (10 W, DC to 9 GHz)
MP640A	Branch	40 dB, DC to 1700 MHz
MP654A	Branch	30 dB, 0.8 to 3 GHz
MP520A	CM Directional Coupler	25 to 500 MHz, 75 Ω (NC)
MP520B	CM Directional Coupler	25 to 1000 MHz, 75 Ω (NC)
MP520C	CM Directional Coupler	25 to 500 MHz, 50 Ω (N)
MP520D	CM Directional Coupler	25 to 1000 MHz, 50 Ω (N)
MP526A	High Pass Filter	60-MHz band
MP526B	High Pass Filter	150-MHz band
MP526C	High Pass Filter	250-MHz band
MP526D	High Pass Filter	400-MHz band
MP526G	High Pass Filter	27-MHz band

† Please specify the model/order number, name, and quantity when ordering.

Optional Accesories (2/2)

Model - Order No.	Name	Remarks
J0055	Coaxial Adaptor	75 Ω , NC-P · BNC-J
J0076	Coaxial Adaptor	75 Ω , NC-P · F-J
MH648A	Pre-amplifer	0.1 to 1200 MHz, 30 dB
HP534A	Dipole Antenna	25 to 520 MHz
MP651A	Dipole Antenna	470 to 1700 MHz
BBA9106/VHA9103	Biconical Antenna	30 to 300 MHz (Schwarzbeck product)
6502	Loop Antenna	10 kHz to 30 MHz (Emco product)
MP414B	Loop Antenna	9 kHz to 30 MHz, 3 bands
MP415B	Rod Antenna	9 kHz to 30 MHz, 3 bands
MP635A	Log Periodic Antenna	80 to 1000 MHz, 30 dB
MP666A	Log Periodic Antenna	200 to 2000 MHz, 30 dB
MB18B	Pole	For MP666A
MB9A	Tripod	For MP666A
MB19A	Tripod	For MP635A/MP666A (with Pole)
MN423B	Artificial Main Network	CISPR Pub. 16,150 kHz to 30 MHz
MN424B	Artificial Main Network	FCC Part 15,450 kHz to 30 MHz
MN425B	Artificial Main Network	VDE 0876,10 kHz to 30 MHz
MA2601B	EMI Prove	5 to 1000 MHz
MA2601C	EMI Prove	1 to 50 MHz
KT-10	EMI Clamp	
KT-20	EMI Prove Kit	
60N50-1	SWR Bridge	5 MHz to 2 GHz, 50 Ω , N-P
60NF50-1	SWR Bridge	5 MHz to 2 GHz, 50 Ω , N-J
62N75	SWR Bridge	10 MHz to 1 GHz, 75 Ω , NC-P
62NF75	SWR Bridge	10 MHz to 1 GHz, 75 Ω , NC-J
87A50	SWR Bridge	2 to 18 GHz, 50 Ω , GPC-7
J0007	GP-IB Cable	408JE-101
J0008	GP-IB Cable	408JE-102
J0742A	RS232C Cable	D-sub 25 pins (straight)
J0743A	RS232C Cable	For IBM PC/AT compatible, D-sub 9pins (cross)

Specifications

Except where noted otherwise, specified values were obtained after warming up the equipment for 30 minutes at a constant ambient temperature and then performing calibration. The typical values are given for reference, and are not guaranteed.

Model		MS2651B	MS2661B	
Frequency	Frequency range	9 kHz to 3 GHz		
	Frequency readout accuracy	$\pm(\text{frequency readout} \times \text{reference frequency accuracy} + \text{span} \times \text{span accuracy} + 100 \text{ Hz})$ * Span: ≥ 10 kHz, after calibration		
	Marker frequency readout accuracy	Normal: Same as frequency readout accuracy, Delta: Same as frequency span accuracy		
	Frequency counter	Resolutions: 1 Hz, 10 Hz, 100 Hz, 1 kHz Accuracy: Frequency readout \times reference frequency accuracy ± 1 LSD (when S/N is 20 dB)		
	Frequency span	Setting range: 0 Hz, 1 kHz to 3.1 GHz Accuracy: $\pm 2.5\%$ (span ≥ 10 kHz)	Setting range: 0 Hz, 1 kHz to 3.1 GHz Accuracy: $\pm 2.5\%$ (span ≥ 10 kHz), $\pm 5\%$ (span ≤ 10 kHz, Option02 installed)	
	Resolution bandwidth (RBW) (3 dB BW)	Setting range: 1 kHz, 3 kHz, 10 kHz, 30 kHz, 100 kHz, 300 kHz, 1 MHz, 5 MHz (manually or automatically settable according to frequency span) * Option02 (MS2661B only): 30 Hz, 100 Hz, 300 Hz are added. Measurements of such as noise, C/N, adjacent channel leakage power by measure function are executed with the calculate equivalent noise bandwidth of the resolution bandwidth. Selectivity (60 dB:3 dB): $\leq 10:1$ (RBW=1 kHz to 300 kHz), $\leq 15:1$ (RBW=1 MHz, 5 MHz)		
	Video bandwidth (VBW)	1 Hz to 3 MHz (1-3 sequence), off* manually or automatically settable according to resolution bandwidth		
	Signal purity and stability	Noise side bands: ≤ 90 dBc/Hz (1 GHz, 10 kHz offset)		Noise side bands: ≤ 100 dBc/Hz (1 GHz, 10 kHz offset)
	Reference oscillator	Frequency: 10 MHz Aging rate: (typical); Option01: 1×10^7 /year, 2×10^8 /day Temperature characteristics: 1×10^8 (typical, 0°C to 50°C); Option01: $\pm 5 \times 10^8$ (0°C to 50°C)		
Amplitude	Level measurement	Measurement range	Average noise level to +30 dBm	
		Maximum input level	+30 dBm (CW average power, input attenuator: ≥ 10 dB), ± 50 Vdc	
		Average noise level	≤ -110 dBm (1 MHz to 1 GHz) ≤ -110 dBm + f [GHz] dB (1 to 3 GHz) * Resolution bandwidth: 1 kHz, video bandwidth: 1 Hz, input attenuator: 0 dB	≤ -115 dBm (1 MHz to 1 GHz) ≤ -115 dBm + f [GHz] dB (1 to 3 GHz) * Resolution bandwidth: 1 kHz, video bandwidth: 1 Hz, input attenuator: 0 dB
		Residual response	≤ -95 dBm (input attenuator: 0 dB, input: 50 Ω termination, 1 MHz to 3 GHz)	≤ -100 dBm (input attenuator: 0 dB, input: 50 Ω termination, 1 MHz to 3 GHz)
	Total level accuracy	± 1.3 dB (100 kHz to 3 GHz) Level measurement accuracy after calibration using internal calibration signal Total level accuracy: reference level accuracy (0 to -49.9 dBm) + frequency response + log linearity (0 to -20 dB)		
	Reference level	Setting range Log scale: -100 to +30 dBm, or equivalent level Linear scale: 224 μ V to 7.07 V Unit Log scale: dBm, dBuV, dBmV, dBuV (e.m.f.), W, dBuV/m Linear scale: V Reference level accuracy: ± 0.4 dB (-49.9 dBm to 0 dBm), ± 0.75 dB (-69.9 to -50 dBm, 0.1 to +30 dBm), ± 1.5 dB (-80 to -70 dBm) * After calibration at 100 MHz frequency, span 1 MHz (when input attenuator, resolution bandwidth, video bandwidth, and sweep time set to AUTO) Resolution bandwidth switching uncertainty: ± 0.3 dB (1 kHz to 1 MHz), ± 0.4 dB (1 kHz to 5 MHz) * After calibration, referenced to resolution bandwidth 3 kHz Input attenuator (RF ATT) Setting range: 0 to 70 dB (10 dB steps) * Manual settable, or automatically settable according to reference level Accuracy: ± 0.3 dB (0 to 50 dB), 1 dB (0 to 70 dB) * After calibration, referenced to frequency 100 MHz, input attenuator 10 dB		
	Frequency response	± 0.5 dB (100 kHz to 3 GHz, referenced to 100 MHz, input attenuator 10 dB, temperature 18° to 28°C) ± 1.5 dB (9 to 100 kHz, referenced to 100 MHz, input attenuator 10 dB, temperature 18° to 28°C) ± 1.0 dB (100 kHz to 3 GHz, referenced to 100 MHz, input attenuator 10 dB to 50 dB)		

(Continued)

Model		MS2651B	MS2661B
Amplitude	Scale Fidelity	Scale: 10 div (at single scale) Log scale: 10, 5, 2, 1 dB/div Linear scale: 10, 5, 2, 1 %/div Linearity (after calibration) Log scale: ± 0.4 dB (0 to -20 dB), ± 1.0 dB (0 to -70 dB), ± 1.5 dB (0 to -85 dB), ± 1.0 dB (0 to -90 dB) Linear scale: ± 4 % of reference level Marker level resolution Log scale: 0.01 dB Linear scale: 0.02 % of reference level	
	Spurious response	2nd harmonic distortion: ≤ -55 dBc (10 to 100 MHz, mixer level: -30 dBm) ≤ -60 dBc (0.1 to 1.5 GHz, mixer level: -30 dBm) 3rd order intermodulation distortion: ≤ -70 dBc (10 MHz to 3 GHz frequency difference of two signals: ≥ 50 kHz, mixer level: -30 dBm)	2nd harmonic distortion: ≤ -60 dBc (10 to 200 MHz, mixer level: -30 dBm) ≤ -75 dBc (0.2 to 1.5 GHz, mixer level: -30 dBm) ≤ -80 dBc (0.8 to 1 GHz, mixer level: -30 dBm) 3rd order intermodulation distortion: ≤ -70 dBc (10 MHz to 100 MHz frequency difference of two signals: ≥ 50 kHz, mixer level: -30 dBm) ≤ -80 dBc (0.1 to 3 GHz frequency difference of two signals: ≥ 50 kHz, mixer level: -30 dBm)
	1 dB gain compression	≥ -5 dBm (≥ 100 MHz, at mixer input level)	
	Maximum dynamic range	1 dB gain compression level vs. average noise level: > 105 dB (100 MHz to 1 GHz) $> 105 - f[\text{GHz}] \text{ dB}$ (> 1 GHz) Distortion characteristics (1 kHz RBW) 2nd harmonic: > 67.5 dB (10 to 100 MHz) > 70 dB (100 to 500 MHz) $> 70 - f[\text{GHz}] \text{ dB}$ (500 to 1500 MHz) 3rd order intermodulation: > 76.6 dB (10 to 1000 MHz) $> 76.6 - (2/3)f[\text{GHz}] \text{ dB}$ (1 to 3 GHz)	1 dB gain compression level vs. average noise level: > 110 dB (100 MHz to 1 GHz) $> 110 - f[\text{GHz}] \text{ dB}$ (> 1 GHz) when Option 08 pre-amplifier installed: > 109 dB (100 MHz to 1 GHz) $> 109 - 1.5f[\text{GHz}] \text{ dB}$ (> 1 GHz) Distortion characteristics (1 kHz RBW) 2nd harmonic: > 72.5 dB (10 to 200 MHz) > 80 dB (200 to 500 MHz) $> 80 - f[\text{GHz}] \text{ dB}$ (500 to 1500 MHz) 3rd order intermodulation: > 72.5 dB (10 to 100 MHz) > 83.3 dB (100 to 1000 MHz) $> 83.3 - (2/3)f[\text{GHz}] \text{ dB}$ (1 to 3 GHz)
Sweep	Sweep time	Setting range: 20 ms to 1000 s (manual settable or automatically settable according to span, resolution bandwidth and video bandwidth) Accuracy: ± 1.5 % (20 ms to 100 s), ± 4.5 % (110 s to 1000 s), ± 1 % (digital zero span mode)	
	Sweep mode	Continuous, single	
	Sweep mode in time domain	Analog zero span, digital zero span	
	Zone sweep	Sweeps only in frequency range indicated by zone marker	
	Tracking sweep	Sweeps while tracking peak points within zone marker (zone sweep also possible)	
Function	Numbers of points	501	
	Detection mode	NORMAL: Simultaneously displays max. and min. points between sample points POS PEAK: Displays max. point between sample points NEG PEAK: Displays min. point between sample points SAMPLE: Displays momentary value at sample points Detection mode switching uncertainty: ± 0.5 dB (at reference level)	
	Display	Color TFT-LCD, Size 5.5", Number of colors: 17 (RGB, each 64-scale settable), Brightness: 5-steps settable	
	Display function	Trace A: Displays frequency spectrum Trace B: Displays frequency spectrum Trace Time: Displays time domain waveform at center frequency Trace A/B: Displays Trace A and Trace B simultaneously, simultaneous sweep of same frequency, alternate sweep of independent frequencies Trace A/BG: Display frequency region to be observed (background) and object band (foreground) selected from background with zone marker simultaneously alternate sweep Trace A/Time: Displays frequency spectrum, and time domain waveform at center frequency simultaneously Trace move/calculation: A \rightarrow B, B \rightarrow A, A \leftrightarrow B, A+B \rightarrow A, A-B+DL \rightarrow A	
	Storage functions	NORMAL, VIEW, MAX HOLD, AVERAGE, CUMULATIVE, OVERWRITE	

(Continued)

Model		MS2651B	MS2661B
Functions	FM demodulation waveform display	Setting range: 2, 5, 10, 20, 50, 100, 200 kHz/div Accuracy: $\pm 5\%$ of full scale (referenced to center frequency after calibration, DC-coupled, RBW 5 MHz, VBW 1 Hz, CW) Frequency response (3 dB): DC (50 Hz at AC coupled) to 100 kHz (range ≤ 20 kHz/div, VBW off), DC (50 Hz at AC coupled) to 500 kHz (range ≥ 50 kHz/div, VBW off) * Usable RBW: ≥ 100 kHz	
	Signal search	AUTO TUNE, PEAK \rightarrow CF, PEAK \rightarrow REF, SCROLL	
	Zone marker	NORMAL, DELTA	
	Marker	MARKER \rightarrow CF, MARKER \rightarrow REF, MARKER \rightarrow CF STEP SIZE, Δ MARKER \rightarrow SPAN, ZONE \rightarrow SPAN	
	Peak search	PEAK, NEXT PEAK, NEXT RIGHT PEAK, NEXT LEFT PEAK, MIN DIP, NEXT DIP	
	Multi-marker	Numbers of markers: 10 max. (HIGHEST 10, HARMONICS, MANUAL SET)	
	Measure	Noise power (dBm/Hz, dBm/ch), C/N (dBc/Hz, dBc/ch), channel power (dBm, dBm/Hz), occupied bandwidth (powerN% method, X-dB down method), adjacent channel leakage power (REF: total power method, REF: reference level method, REF: inband method, channel designate display: 2 channels \times 2, graphic display), average power of burst signal (average power in designate time range of time domain waveform), template comparison (upper/lower limits \times each 2, time domain), MASK (upper/lower limits \times each 2, frequency domain)	
	Save/recall	Save and recall setting conditions and waveform data to internal memory (max. 12) or memory card	
	Hard copy	Printer (HP dotmatrix, EPSON dotmatrix or compatible model): Display data can be hard-copied via the RS232C, GPIB, or Centronics (Option10) interface Plotter (HP-GL, GP-GL compatible models): Display data can be hard-copied via the RS232C or GPIB interface	
	PTA	Language: PTL (interpreter based on BASIC) Programming: Using editor of external computer Programming memory: Memory card, upload/download to/from external computer Programming capacity: 192 kbytes Data processing: Directly accesses measurement data according to system variables, system subroutines, and system functions	
	RS-232C	Output data to printer or plotter. Control from external computer (excluding power switch)	
	GPIB interface	Functions: Meets IEEE488.2, Can be controlled as device from external controller (excluding power switch), or can control external equipment as controller Interface functions: SH1, AH1, T6, L4, SR1, RL1, PP0, DC1, DT1, C1, C2, C3, C4, C28	
	Memory card interface	Functions: Save/recall measurement settings and data, uploads/downloads PTA programs, access SRAM, EPROM and flash EEPROM (can write to SRAM only), Supports cards up to 2 MB Connector: PCMCIA Ver.2.0 2 slots	
	Others	Correction	Autocorrection of MA1621A impedance transformer insertion loss Correction accuracy (input attenuator: ≥ 10 dB): ± 2.5 dB (9 to 100 kHz), ± 1.5 dB (100 kHz to 2 GHz), ± 2.0 dB ⁻¹ (2 to 3 GHz) Antenna factor Indication of the correction waveform data by antenna factor of a designated antenna and measurement of field strength (dB μ V/m) Built-in antenna factor Dipole antenna: MP534A/MP651A Log-Periodic Antenna: MP635A/MP666A Loop Antenna: MP414B Use: Programmable through GPIB or RS-232C or PTA (4 types) Saving/Loading to/from Memory card possible
Conducted emission		Meets the EN55011 (Group 1, Class A)	
Radiated emission		Meets the EN55011 (Group 1, Class A)	
Static discharge		Meets the EN50082-1	
Radiation field		Meets the EN50082-1	
Conducted susceptibility		Meets the IEC801-4 (Level II)	
Vibration		Meets the MIL-STD-810D	
Power (operating range)		85 to 132 / 170 to 250 V (automatic voltage switching), 47.5 to 63 Hz/380 to 420 Hz (85 to 132 V only), ≤ 320 VA	
Dimensions and mass		320 (W) \times 177 (H) \times 351 (D), ≤ 10.8 kg (without option)	
Ambient temperature		0° to 50°C (operate), -40° to +75°C (storage)	

(Continued)

Model		MS2653B	MS2663B		
Frequency	Frequency range	9 kHz to 8.1 GHz			
	Frequency band	Band 0 (0 to 3.2 GHz), band 1- (2.92 GHz to 6.5 GHz), band 1+ (6.4 GHz to 8.1 GHz)			
	Pre-selector range	2.92 GHz to 8.1 GHz (band 1-, band 1+)			
	Frequency readout accuracy	\pm (frequency readout \times reference frequency accuracy + span \times span accuracy + 100 Hz) *Span: \geq 10 kHz, after calibration			
	Marker frequency readout accuracy	Normal: Same as frequency readout accuracy, Delta: Same as frequency span accuracy			
	Frequency counter	Resolutions: 1 Hz, 10 Hz, 100 Hz, 1 kHz Accuracy: Frequency readout \times reference frequency accuracy \pm 1 LSD (when S/N is 20 dB)			
	Frequency span	Setting range: 0 Hz, 1 kHz to 8.2 GHz Accuracy: \pm 2.5 % (span \geq 10 kHz)	Setting range: 0 Hz, 1 kHz to 8.2 GHz Accuracy: \pm 2.5 % (span \geq 10 kHz), \pm 5 % (span \leq 10 kHz, Option02 installed)		
	Resolution bandwidth (RBW) (3 dB BW)	Setting range: 1 kHz, 3 kHz, 10 kHz, 30 kHz, 100 kHz, 300 kHz, 1 MHz, 5 MHz (manually or automatically settable according to frequency span) *Option02 (MS2663B only): 30 Hz, 100 Hz, 300 Hz are added. Measurements of such as noise, C/N, adjacent channel leakage power by measure function are executed with the calculated equivalent noise band width of the resolution band width. Selectivity (60 dB: 3 dB): \leq 10:1 (RBW=1 kHz to 300 kHz), \leq 15:1 (RBW=1 MHz, 5 MHz)			
	Video bandwidth (VBW)	1 Hz to 3 MHz (1-3 sequence), off *manually or automatically settable according to resolution bandwidth			
	Signal purity and stability	Noise sidebands: \leq -90 dBc/Hz (1 GHz, 10 kHz offset)	Noise sidebands: \leq -100 dBc/Hz (1 GHz, 10 kHz offset)		
Reference oscillator	Frequency: 10 MHz Aging rate: (typical): Option01: 1×10^{-7} /year, 2×10^{-6} /day Temperature characteristics: 1×10^{-6} (typical, 0°C to 50°C); Option01: $\pm 5 \times 10^{-6}$ (0°C to 50°C)				
Amplitude	Level measurement	Measurement range	Average noise level to +30 dBm		
		Maximum input level	+30 dBm (CW average power, input attenuator: \geq 10 dB), ± 0 Vdc		
		Average noise level	\leq -110 dBm (1 MHz to 1 GHz, band 0) \leq -110 dBm + f[GHz]dB (1 to 3.1 GHz, band 0) \leq -110 dBm + 0.5f[GHz]dB (2.92 to 8.1 GHz, band 1) *Resolution bandwidth: 1 kHz, video bandwidth: 1 Hz, input attenuator: 0 dB	\leq -115 dBm (1 MHz to 1 GHz, band 0) \leq -115 dBm + 1.5f[GHz]dB (1 to 3 GHz, band 0) \leq -115 dBm + 0.5f[GHz]dB (2.92 to 8.1 GHz, band 1) *Resolution bandwidth: 1 kHz, video bandwidth: 1 Hz, input attenuator: 0 dB	
		Residual response	\leq -95 dBm (input attenuator: 0 dB, input: 50 Ω termination, 1 MHz to 8.1 GHz)	\leq -100 dBm (input attenuator: 0 dB, input: 50 Ω termination, 1 MHz to 8.1 GHz)	
	Total level accuracy	\pm 1.3 dB (100 kHz to 3 GHz), \pm 1.8 dB (3.1 to 8.1 GHz) Level measurement accuracy after calibration using internal calibration signal Total level accuracy: reference level accuracy (0 to -49.9 dBm) + frequency response + log linearity (0 to -20 dB)			
	Reference level	Setting range Log scale: -100 to +30 dBm, or equivalent level Linear scale: 224 μ V to 7.07 V Unit Log scale: dBm, dB μ V, dBmV, dB μ V(e.m.f), W, dB μ V/m Linear scale: V Reference level accuracy: \pm 0.4 dB (-49.9 dBm to 0 dBm), \pm 0.75 dB (-69.9 to -50 dBm, 0.1 to +30 dBm), \pm 1.5 dB (-80 to -70 dBm) *After calibration at 100 MHz frequency, span 1 MHz (when input attenuator, resolution bandwidth, video bandwidth, and sweep time set to AUTO) Resolution bandwidth switching uncertainty: \pm 0.3 dB (1 kHz to 1 MHz), \pm 0.4 dB (1 kHz to 5 MHz) *After calibration, referenced to resolution bandwidth 3 kHz Input attenuator (RF ATT) Setting range: 0 to 70 dB (10 dB steps) *Manual settable or, automatically settable according to reference level Accuracy: \pm 0.3 dB (0 to 50 dB), 1 dB (0 to 70 dB) *After calibration, referenced to frequency 100 MHz, input attenuator 10 dB			
Frequency response	\pm 0.5 dB (100 kHz to 3.2 GHz, band 0, referenced to 100 MHz, input attenuator 10 dB, temperature 18° to 28°C) \pm 1.5 dB (9 to 100 kHz, band 0, referenced to 100 MHz, input attenuator 10 dB, temperature 18° to 28°C) \pm 1.5 dB (2.92 to 8.1 GHz, band 1, referenced to 100 MHz, input attenuator 10 dB, temperature 18° to 28°C) \pm 1.0 dB (100 kHz to 3.2 GHz, band 0, referenced to 100 MHz, input attenuator 10 dB to 50 dB) \pm 1.0 dB (2.92 to 8.1 GHz, band 1, referenced to 100 MHz, input attenuator 10 dB to 50 dB) *At band 1, after pre-selector tuning				

(Continued)

Model		MS2653B	MS2663B
Amplitude	Scale Fidelity/Spurious response	Scale: 10 div (at single scale) Log scale: 10, 5, 2, 1 dB/div Linear scale: 10, 5, 2, 1 %/div Linearity (after calibration) Log scale: ± 0.4 dB (0 to -20 dB), ± 1.0 dB (0 to -70 dB), ± 1.5 dB (0 to -85 dB), ± 1.0 dB (0 to -90 dB) Linear scale: ± 4 % of reference level Marker level resolution Log scale: 0.01 dB Linear scale: 0.02 % of reference level	
		2nd harmonic distortion: ≤ -55 dBc (10 to 100 MHz, band 0, mixer level: -30 dBm) ≤ -60 dBc (0.1 to 1.55 GHz, band 0, mixer level: -30 dBm) ≤ -100 dBc (1.46 to 4.05 GHz, band 1, mixer level: -20 dBm)	2nd harmonic distortion: ≤ -60 dBc (10 to 200 MHz, band 0, mixer level: -30 dBm) ≤ -75 dBc (0.2 to 1.3 GHz, band 0, mixer level: -30 dBm) ≤ -70 dBc (1.3 to 1.55 GHz, band 0, mixer level: -30 dBm) ≤ -80 dBc (0.8 to 1 GHz, mixer level: -30 dBm) ≤ -100 dBc (1.46 to 4.05 GHz, band 1, mixer level: -20 dBm)
		3rd order intermodulation distortion: ≤ -70 dBc (10 MHz to 8.1 GHz frequency difference of two signal: ≥ 50 kHz, mixer level: -30 dBm)	3rd order intermodulation distortion: ≤ -70 dBc (10 MHz to 100 MHz frequency difference of two signal: ≥ 50 kHz, mixer level: -30 dBm) ≤ -80 dBc (0.1 to 8.1 GHz frequency difference of two signal: ≥ 50 kHz, mixer level: -30 dBm)
		Image response: ≤ -70 dBc Multiplex response: ≤ -70 dBc	
	1 dB gain compression	≥ -5 dBm (≥ 100 MHz, at mixer input level)	
	Maximum dynamic range	1 dB gain compression level to average noise level: > 105 dB (100 MHz to 1 GHz, band 0) $> 105 - f[\text{GHz}] \text{ dB}$ (1 to 3.1 GHz, band 0) $> 105 - 0.5f[\text{GHz}] \text{ dB}$ (2.92 to 8.1 GHz, band 1) Distortion characteristics (1 kHz RBW) 2nd harmonic: > 67.5 dB (10 to 100 MHz) > 70 dB (100 to 500 MHz) $> 70 - 0.5f[\text{GHz}] \text{ dB}$ (0.5 to 1.55 GHz, band 0) $> 95 - 0.25f[\text{GHz}] \text{ dB}$ (1.46 to 4.05 GHz, band 1) 3rd order intermodulation: > 76.6 dB (10 to 100 MHz) $> 76.6 - (2/3)f[\text{GHz}] \text{ dB}$ (1 to 3.1 GHz, band 0) $> 76.6 - (1/3)f[\text{GHz}] \text{ dB}$ (2.92 to 8.1 GHz, band 1)	1 dB gain compression level vs. average noise level: > 110 dB (100 MHz to 1 GHz, band 0) $> 110 - 1.5f[\text{GHz}] \text{ dB}$ (1 to 3.1 GHz, band 0) $> 110 - 0.5f[\text{GHz}] \text{ dB}$ (2.92 to 8.1 GHz, band 1) Distortion characteristics (1 kHz RBW) 2nd harmonic: > 72.5 dB (10 to 200 MHz) > 80 dB (200 to 500 MHz) $> 80 - 0.75f[\text{GHz}] \text{ dB}$ (0.5 to 1.3 GHz, band 0) $> 82.5 - 0.75f[\text{GHz}] \text{ dB}$ (0.8 to 1 GHz, band 0) $> 77.5 - 0.75f[\text{GHz}] \text{ dB}$ (1.3 to 1.55 GHz, band 0) $> 97.5 - 0.25f[\text{GHz}] \text{ dB}$ (1.46 to 4.05 GHz, band 1) 3rd order intermodulation: > 80 dB (10 to 100 MHz) > 83.3 dB (0.1 to 1 GHz) $> 83.3 - f[\text{GHz}] \text{ dB}$ (1 to 3.1 GHz, band 0) $> 83.3 - (1/3)f[\text{GHz}] \text{ dB}$ (1.46 to 8.1 GHz, band 1)
Sweep	Sweep time	Setting range: 20 ms to 1000 s (manual settable, or automatically settable according to span, resolution bandwidth and video bandwidth) Accuracy: ± 15 % (20 ms to 100 s), ± 45 % (110 s to 1000 s), ± 1 % (digital zero span mode)	
	Sweep mode	Continuous, single	
	Sweep mode in time domain	Analog zero span, digital zero span	
	Zone sweep	Sweeps only in frequency range indicated by zone marker	
	Tracking sweep	Sweeps while tracking peak points within zone marker (zone sweep also possible)	
Functions	Numbers of points	501	
	Detection mode	NORMAL: Simultaneously displays max. and min. points between sample points POS PEAK: Displays max. point between sample points NEG PEAK: Displays min. point between sample points SAMPLE: Displays momentary value at sample points Detection mode switching uncertainty: ± 0.5 dB (at reference level)	
	Display	Color TFT-LCD, Size 5.5", Number of colors: 17 (RGB, each 64-scale settable), Brightness: 5-steps settable	
	Display function	Trace A: Displays frequency spectrum Trace B: Displays frequency spectrum Trace Time: Displays time domain waveform at center frequency Trace A/B: Displays Trace A and Trace B simultaneously, simultaneous sweep of same frequency, alternate sweep of independent frequencies Trace A/BG: Display frequency region to be observed (background) and object band (foreground) selected from background with zone marker simultaneously alternate sweep Trace A/Time: Displays frequency spectrum, and time domain waveform at center frequency simultaneously Trace move/calculation: A \rightarrow B, B \rightarrow A, A \leftrightarrow B, A + B \rightarrow A, A - B \rightarrow DL \rightarrow A	
	Storage functions	NORMAL, VIEW, MAX HOLD, AVERAGE, CUMULATIVE, OVERWRITE	

Model		MS2653B	MS2663B
Functions	FM demodulation waveform display	Setting range: 2.5, 10, 20, 50, 100, 200 kHz/div Accuracy: $\pm 5\%$ of full scale (referenced to center frequency after calibration, DC-coupled, RBW 5 MHz, VBW 1 Hz, CW) Frequency response (3 dB): DC (50 Hz at AC coupled) to 100 kHz (range ≤ 20 kHz/div, VBW off) DC (50 Hz at AC coupled) to 500 kHz (range ≥ 50 kHz/div, VBW off) * Usable RBW: ≥ 100 kHz	
	Signal search	AUTO TUNE, PEAK \rightarrow CF, PEAK \rightarrow REF, SCROLL	
	Zone marker	NORMAL, DELTA	
	Marker	MARKER \rightarrow CF, MARKER \rightarrow REF, MARKER \rightarrow CF STEP SIZE, Δ MARKER \rightarrow SPAN, ZONE \rightarrow SPAN	
	Peak search	PEAK, NEXT PEAK, NEXT RIGHT PEAK, NEXT LEFT PEAK, MIN DIP, NEXT DIP	
	Multi-marker	Numbers of markers: 10 max. (HIGHEST 10, HARMONICS, MANUAL SET)	
	Measure	Noise power (dBm/Hz, dBm/ch), C/N (dBc/Hz, dBc/ch), channel power (dBm, dBm/Hz), occupied bandwidth (powerN% method, X-dB down method), adjacent channel leakage power (REF: total power method, REF: reference level method, REF: inband method, channel designate display: 2 channels \times 2, graphic display), average power of burst signal (average power in designate time range of time domain waveform), template comparison (upper/lower limits \times each 2, time domain), MASK (upper/lower limits \times each 2, frequency domain)	
	Save/recall	Save and recall setting conditions and waveform data to internal memory (max. 12) or memory card	
	Hard copy	Printer (HP dotmatrix, EPSON dotmatrix or compatible model): Display data can be hard-copied via the RS232C, GPIB, or Centronics (Option 10) interface Plotter (HP-GL, GP-GL compatible models): Display data can be hard-copied via the RS232C or GPIB interface	
	PTA	Language: PTL (interpreter based on BASIC) Programming: Using editor of external computer Programming memory: Memory card, upload/download to/from external computer Programming capacity: 192 kbytes Data processing: Directly accesses measurement data according to system variables, system subroutines, and system functions	
	RS-232C	Output data to printer or plotter. Control from external computer (excluding power switch)	
	GPIB interface	Functions: Meets IEEE488.2, Can be controlled as device from external controller (excluding power switch), or can control external equipment as controller Interface functions: SH1, AHI, T6, L4, SRI, RL1, PP0, DC1, DT1, C1, C2, C3, C4, C28	
	Memory card interface	Functions: Save/recall measurement settings and data, uploads/downloads PTA programs, access SRAM, EPROM and flash EEPROM (can write to SRAM only), Supports cards up to 2 MB Connector: PCMCIA Ver.2.0 2 slots	
Correction	Autocorrection of MA1621A impedance transformer insertion loss Correction accuracy (input attenuator: ≥ 10 dB): ± 2.5 dB (9 to 100 kHz), ± 1.5 dB (100 kHz to 2 GHz), ± 2.0 dB* (2 to 3 GHz) Antenna factor Indication of the correction waveform data by antenna factor of a designated antenna and measurement of field strength (dB μ V/m) Built-in antenna factor Dipole antenna: MP534A/MP651A Log-Periodic Antenna: MP635A/MP666A Loop Antenna: MP414B Use: Programmable through GPIB or RS-232C or PTA (4 types) Saving/Loading to/from Memory card possible		
Others	Conducted emission	Meets the EN55011 (Group 1, Class A)	
	Radiated emission	Meets the EN55011 (Group 1, Class A)	
	Static discharge	Meets the EN50082-1	
	Radiation field	Meets the EN50082-1	
	Conducted susceptibility	Meets the IEC801-4 (Level II)	
	Vibration	Meets the MIL-STD-810D	
	Power (operating range)	85 to 132 / 170 to 250 V (automatic voltage switching), 47.5 to 63 Hz / 380 to 420 Hz (85 to 132 V only) ≤ 320 VA	
Dimensions and mass	320 (W) \times 177 (H) \times 351 (D), ≤ 13.5 kg (without option)		
Ambient temperature	0° to 50°C (operate), -40° to +75°C (storage)		

(Continued)

Model		MS2661C	
Frequency	Frequency range	9 kHz to 3 GHz	
	Frequency readout accuracy	\pm (frequency readout \times reference frequency accuracy + span \times span accuracy + 100 Hz) * Span: ≥ 10 kHz, after calibration	
	Marker frequency readout accuracy	Normal: Same as frequency readout accuracy. Delta: Same as frequency span accuracy	
	Frequency counter	Resolutions: 1 Hz, 10 Hz, 100 Hz, 1 kHz Accuracy: Frequency readout \times reference frequency accuracy ± 1 LSD (when S/N is 20 dB)	
	Frequency span	Setting range: 0 Hz, 1 kHz to 3.1 GHz Accuracy: ± 2.5 % (span ≥ 10 kHz), ± 5 % (span ≤ 10 kHz, Option02 installed)	
	Resolution bandwidth (RBW) (3 dB BW)	Setting range: 1 kHz, 3 kHz, 10 kHz, 30 kHz, 100 kHz, 300 kHz, 1 MHz, 3 MHz (manually or automatically settable according to frequency span) * Option02: 30 Hz, 100 Hz, 300 Hz are added. Measurements of such as noise, C/N, adjacent channel leakage power by measure function are executed with the calculated equivalent noise bandwidth of the resolution bandwidth. Accuracy: ± 20 % (RBW=1 kHz to 1 MHz), ± 30 % (RBW=3 MHz) Selectivity (60 dB/3 dB): $\leq 15:1$	
	Video bandwidth (VBW)	1 Hz to 3 MHz (1-3 sequence), off* manually or automatically settable according to resolution bandwidth	
	Signal purity and stability	Noise sidebands: ≤ 100 dBc/Hz (1 GHz, 10 kHz offset) Residual FM: ≤ 20 Hzp-p/0.1 sec (1 GHz, span=0 Hz) Frequency drift: ≤ 200 Hz/min (span ≤ 10 kHz, sweep time ≤ 100 sec)* After 1-hour warm-up at constant ambient temperature	
	Reference oscillator	Frequency: 10 MHz Aging rate: (typical); Option01: 1×10^7 /year, 2×10^8 /day Temperature characteristics: 1×10^5 (typical, 0°C to 50°C); Option01: $\pm 5 \times 10^4$ (0°C to 50°C)	
	Amplitude	Level measurement	Measurement range
Maximum input level			+30 dBm (CW average power, input attenuator: ≥ 10 dB), ± 50 Vdc
Average noise level			≤ 115 dBm (1 MHz to 1 GHz) ≤ 115 dBm + f[GHz]dB (1 to 3 GHz) When Option08 pre-amplifier installed: ≤ 114 dBm (1 MHz to 1 GHz) ≤ 114 dBm + 1.5f[GHz]dB (>1 GHz) * Resolution bandwidth: 1 kHz, video bandwidth: 1 Hz, input attenuator: 0 dB
Residual response			≤ 100 dBm (input attenuator: 0 dB, input: 50 Ω termination, 1 MHz to 3 GHz)
Total level accuracy		± 1.3 dB (100 kHz to 3 GHz) Level measurement accuracy after calibration using internal calibration signal Total level accuracy: reference level accuracy (0 to -49.9 dBm) + frequency response + log linearity (0 to -20 dB)	
Reference level		Setting range Log scale: -100 to +30 dBm, or equivalent level Linear scale: 224 μ V to 7.07 V Unit Log scale: dBm, dB μ V, dBmV, dB μ V (e.m.f. W, dB μ V/m Linear scale: V Reference level accuracy: ± 0.4 dB (-49.9 dBm to 0 dBm), ± 0.75 dB (-69.9 to -50 dBm, 0.1 to +30 dBm), ± 1.5 dB (-80 to -70 dBm) * After calibration at 100 MHz frequency, span 1 MHz (when input attenuator, resolution bandwidth, video bandwidth, and sweep time set to AUTO) Resolution bandwidth switching uncertainty: ± 0.3 dB (1 kHz to 1 MHz), ± 0.4 dB (1 kHz to 3 MHz) * After calibration, referenced to resolution bandwidth 3 kHz Input attenuator (RF ATT) Setting range: 0 to 70 dB (10 dB steps) * Manual settable or automatically settable according to reference level Accuracy: ± 0.3 dB (0 to 50 dB), 1 dB (0 to 70 dB) * After calibration, referenced to frequency 100 MHz, input attenuator 10 dB	
Frequency response	± 0.5 dB (100 kHz to 3 GHz, referenced to 100 MHz, input attenuator 10 dB, temperature 18° to 28°C) ± 1.5 dB (9 to 100 kHz, referenced to 100 MHz, input attenuator 10 dB, temperature 18° to 28°C) ± 1.0 dB (100 kHz to 3 GHz, referenced to 100 MHz, input attenuator 10 dB to 50 dB)		

Model		MS2661C
Amplitude	Scale Fidelity	Scale: 10 div (at single scale) Log scale: 10, 5, 2, 1 dB/div Linear scale: 10, 5, 2, 1 %/div Linearity (after calibration) Log scale: ± 0.4 dB (0 to -20 dB), ± 1.0 dB (0 to -70 dB), ± 1.5 dB (0 to -85 dB), ± 1.0 dB (0 to -90 dB) Linear scale: ± 4 % of reference level Marker level resolution Log scale: 0.01 dB Linear scale: 0.02 % of reference level
	Spurious response	2nd harmonic distortion: ≤ -60 dBc (10 to 200 MHz, mixer level: -30 dBm) ≤ -75 dBc (0.2 to 1.5 GHz, mixer level: -30 dBm) ≤ -80 dBc (0.8 to 1 GHz, mixer level: -30 dBm) 3rd order intermodulation distortion: ≤ -70 dBc (10 MHz to 100 MHz frequency difference of two signals: ≥ 50 kHz, mixer level: -30 dBm) ≤ -80 dBc (0.1 to 3 GHz frequency difference of two signals: ≥ 50 kHz, mixer level: -30 dBm)
	1 dB gain compression	≥ -5 dBm (≥ 100 MHz, at mixer input level)
	Maximum dynamic range	1 dB gain compression level vs. average noise level: > 110 dB (100 MHz to 1 GHz) $> 110 - f[\text{GHz}] \text{dB}$ (> 1 GHz) when Option 08 pre-amplifier installed: > 109 dB (100 MHz to 1 GHz) $> 109 - 1.5f[\text{GHz}] \text{dB}$ (> 1 GHz) Distortion characteristics (1 kHz RBW) 2nd harmonic: > 72.5 dB (10 to 200 MHz) > 80 dB (200 to 500 MHz) $> 80 - f[\text{GHz}] \text{dB}$ (500 to 1500 MHz) 3rd order intermodulation: > 72.5 dB (10 to 100 MHz) > 83.3 dB (100 to 1000 MHz) $> 83.3 - (2/3)f[\text{GHz}] \text{dB}$ (1 to 3 GHz)
Sweep	Sweep time	Setting range: 20 ms to 1000 s (manual settable, or automatically settable according to span, resolution bandwidth and video bandwidth) Accuracy: ± 15 % (20 ms to 100 s), ± 45 % (110 s to 1000 s), ± 1 % (digital zero span mode)
	Sweep mode	Continuous, single
	Sweep mode in time domain	Analog zero span digital zero span
	Zone sweep Tracking sweep	Sweeps only in frequency range indicated by zone marker Sweeps while tracking peak points within zone marker (zone sweep also possible)
Function	Numbers of points	501
	Detection mode	NORMAL: Simultaneously displays max. and min. points between sample points POS PEAK: Displays max. point between sample points NEG PEAK: Displays min. point between sample points SAMPLE: Displays momentary value at sample points Detection mode switching uncertainty: ± 0.5 dB (at reference level)
	Display	Color TFT-LCD, Size 5.5". Number of colors: 17 (RGB, each 64 scale settable). Brightness: 5-scale settable
	Display function	Trace A: Displays frequency spectrum Trace B: Displays frequency spectrum Trace Time: Displays time domain waveform at center frequency Trace A/B: Displays Trace A and Trace B simultaneously, simultaneous sweep of same frequency, alternate sweep of independent frequencies Trace A/BG: Display frequency region to be observed (background) and object band (foreground) selected from background with zone marker simultaneously alternate sweep Trace A/Time: Displays frequency spectrum, and time domain waveform at center frequency simultaneously Trace move/calculation: A \rightarrow B, B \rightarrow A, A \leftrightarrow B, A + B \rightarrow A, A - B + DL \rightarrow A
	Storage functions	NORMAL, VIEW, MAX HOLD, AVERAGE, CUMULATIVE, OVERWRITE

(Continued)

Model	MS2661C	
Functions	<p>FM demodulation waveform display</p> <p>Setting range: 2, 5, 10, 20, 50, 100, 200 kHz/div Accuracy: $\pm 5\%$ of full scale (referenced to center frequency after calibration. DC-coupled, RBW 3 MHz, VBW 1 Hz, CW) Frequency response (3 dB): DC (50 Hz at A C coupled) to 100 kHz (range ≤ 20 kHz/div, VBW off), DC (50 Hz at A C coupled) to 500 kHz (range ≥ 50 kHz/div, VBW off) *Usable RBW: ≥ 1 kHz</p>	
	Signal search	AUTO TUNE, PEAK \rightarrow CF, PEAK \rightarrow REF, SCROLL
	Zone marker	NORMAL, DELTA
	Marker	MARKER \rightarrow CF, MARKER \rightarrow REF, MARKER \rightarrow CF STEP SIZE Δ MARKER \rightarrow SPAN, ZONE \rightarrow SPAN
	Peak search	PEAK, NEXT PEAK, NEXT RIGHT PEAK, NEXT LEFT PEAK, MIN DIP, NEXT DIP
	Multi-marker	Numbers of markers: 10 max. (HIGHEST 10, HARMONICS, MANUAL SET)
	Measure	Noise power (dBm/Hz, dBm/ch), C/N (dBc/Hz, dBc/ch), channel power (dBm, dBm/Hz), occupied bandwidth (power N% method, X-dB down method), adjacent channel leakage power (REF: total power method, REF: reference level method, REF: inband method, channel designate display: 2 channels \times 2, graphic display), average power of burst signal (average power in designated time range of time domain waveform), template comparison (upper/lower limits \times each time domain), MASK (upper/lower limits \times each 2, frequency domain)
	Save/recall	Save and recall setting conditions and waveform data to internal memory (max. 12) or memory card
	Hard copy	Printer (HP dotmatrix, EPSON dotmatrix or compatible model): Display data can be hard-copied via the RS232C, GPIB, or Centronics (Option 10) interface Plotter (HP-GL, GP-GL compatible models): Display data can be hard-copied via the RS232C or GPIB interface
	PTA	Language: PTL (interpreter based on BASIC) Programming: Using editor of external computer Programming memory: Memory card, upload/download to/from external computer Programming capacity: 192 kbytes Data processing: Directly accesses measurement data according to system variables, system subroutines, and system functions
	RS-232C	Output data to printer or plotter. Control from external computer (excluding power switch)
	GPIB interface	Functions: Meets IEEE488.2. Can be controlled as device from external controller (excluding power switch), or can control external equipment as controller Interface functions: SH1, AHI, T6, L4, SR1, RL1, PP0, DC1, DT1, C1, C2, C3, C4, C28
	Memory card interface	Functions: Save/recall measurement settings and data, uploads/downloads PTA programs, access SRAM, EPROM and flash EEPROM (can write to SRAM only), Supports cards up to 2 MB Connector: PCMCIA Ver 2.0 2 slots
	Others	Correction
Conducted emission		Meets the EN55011 (Group 1, Class A)
Radiated emission		Meets the EN55011 (Group 1, Class A)
Static discharge		Meets the EN50082-1
Radiation field		Meets the EN50082-1
Conducted susceptibility		Meets the IEC801-4 (Level II)
Vibration		Meets the MIL-STD-810D
Power (operating range)		85 to 132 / 170 to 250 V (automatic voltage switching), 47.5 to 63 Hz/380 to 420 Hz (85 to 132 V only), ≤ 330 VA
Dimensions and mass		320 (W) \times 177 (H) \times 351 (D), ≤ 10.8 kg (without option)
Ambient temperature		0° to 50°C (operate), -40° to +75°C (storage)

Model		MS2663C	
Frequency	Frequency range	9 kHz to 8.1 GHz	
	Frequency band	Band 0 (0 to 3.2 GHz), band 1 - (2.92 GHz to 6.5 GHz), band 1+ (6.4 GHz to 8.1 GHz)	
	Pre-selector range	2.92 GHz to 8.1 GHz (band 1-, band 1+)	
	Frequency readout accuracy	\pm (frequency readout \times reference frequency accuracy + span \times span accuracy + 100 Hz) *Span: \geq 10 kHz, after calibration	
	Marker frequency readout accuracy	Normal: Same as frequency readout accuracy, Delta: Same as frequency span accuracy	
	Frequency counter	Resolutions: 1 Hz, 10 Hz, 100 Hz, 1 kHz Accuracy: Frequency readout \times reference frequency accuracy \pm 1 LSD (when S/N is 20 dB)	
	Frequency span	Setting range: 0 Hz, 1 kHz to 8.2 GHz Accuracy: \pm 2.5 % (span \geq 10 kHz), \pm 5 % (span \leq 10 kHz, Option02 installed)	
	Resolution bandwidth (RBW) (3 dB BW)	Setting range: 1 kHz, 3 kHz, 10 kHz, 30 kHz, 100 kHz, 300 kHz, 1 MHz, 3 MHz (manually or automatically settable according to frequency span) *Option02: 30 Hz, 100 Hz, 300 Hz are added. Measurements of such as noise, C/N, adjacent channel leakage power by measure function are executed with the calculated equivalent noise bandwidth of the resolution bandwidth. Accuracy: \pm 20 % (RBW=1 kHz to 1 MHz), \pm 30 % (RBW=3 MHz) Selectivity (60 dB:3 dB): \leq 15:1	
	Video bandwidth (VBW)	1 Hz to 3 MHz (1-3 sequence), off*manually or automatically settable according to resolution bandwidth	
	Signal purity and stability	Noise sidebands: \leq -100 dBc/Hz (1 GHz, 10 kHz offset) Residual FM: \leq 20 Hzp-p/0.1 sec (1 GHz, span=0 Hz) Frequency drift: \leq 200 Hz/min (span \leq 10 kHz, sweep time \leq 100 sec)*After 1-hour warm-up at constant ambient temperature	
	Reference oscillator	Frequency: 10 MHz Aging rate: (typical): Option01: 1×10^7 /year, 2×10^6 /day Temperature characteristics: 1×10^6 (typical, 0°C to 50°C); Option01: $\pm 5 \times 10^6$ (0°C to 50°C)	
	Amplitude	Measurement range	Average noise level to +30 dBm
Maximum input level		+30 dBm (CW average power, input attenuator: \geq 10 dB), \pm 0 Vdc	
Level measurement		Average noise level	\leq -115 dBm (1 MHz to 1 GHz, band 0) \leq -115 dBm + f[GHz]dB (1 to 3.1 GHz, band 0) \leq -115 dBm + 0.5f[GHz]dB (2.92 to 8.1 GHz, band 1) When Option08 pre-amplifier installed: \leq -114 dBm (1 MHz to 1 GHz, band 0) \leq -114 dBm + 1.5f[GHz]dB (1 to 3.1 GHz, band 0) \leq -115 dBm + 0.5fdB (2.92 to 8.1 GHz, band 1) *Resolution bandwidth: 1 kHz, video bandwidth: 1 Hz, input attenuator: 0 dB, f: frequency [GHz]
		Residual response	\leq -100 dBm (input attenuator: 0 dB, input: 50 Ω termination, 1 MHz to 8.1 GHz)
Total level accuracy		\pm 1.3 dB (100 kHz to 3.1 GHz), \pm 1.8 dB (2.92 to 8.1 GHz) Level measurement accuracy after calibration using internal calibration signal Total level accuracy: reference level accuracy (0 to -49.9 dBm) + frequency response + log linearity (0 to -20 dB)	
Reference level		Setting range Log scale: -100 to +30 dBm, or equivalent level Linear scale: 224 μ V to 7.07 V Unit Log scale: dBm, dBuV, dBmV, dBuV (e.m.f.), W, dBuV/m Linear scale: V Reference level accuracy: \pm 0.4 dB (-49.9 dBm to 0 dBm), \pm 0.75 dB (-69.9 to -50 dBm, 0.1 to +30 dBm), \pm 1.5 dB (-80 to -70 dBm) *After calibration at 100 MHz frequency, span 1 MHz (when input attenuator, resolution bandwidth, video bandwidth, and sweep time set to AUTO) Resolution bandwidth switching uncertainty: \pm 0.3 dB (1 kHz to 1 MHz), \pm 0.4 dB (1 kHz to 3 MHz) *After calibration, referenced to resolution bandwidth 3 kHz Input attenuator (RF ATT) Setting range: 0 to 70 dB (10 dB steps) *Manual settable or, automatically settable according to reference level Accuracy: \pm 0.3 dB (0 to 50 dB), 1 dB (0 to 70 dB) *After calibration, referenced to frequency 100 MHz, input attenuator 10 dB	
Frequency response		\pm 0.5 dB (100 kHz to 3.2 GHz, band 0, referenced to 100 MHz, input attenuator 10 dB, temperature 18° to 28°C) \pm 1.5 dB (9 to 100 kHz, band 0, referenced to 100 MHz, input attenuator 10 dB, temperature 18° to 28°C) \pm 1.5 dB (2.92 to 8.1 GHz, band 1, referenced to 100 MHz, input attenuator 10 dB, temperature 18° to 28°C) \pm 1.0 dB (100 kHz to 3.2 GHz, band 0, referenced to 100 MHz, input attenuator 10 dB to 50 dB)	

(Continued)

Model		MS2663C
Amplitude	Scale Fidelity	Scale: 10 div (at single scale) Log scale: 10, 5, 2, 1 dB/div Linear scale: 10, 5, 2, 1 %/div Linearity(after calibration) Log scale: ± 0.4 dB (0 to -20 dB), ± 1.0 dB (0 to -70 dB), ± 1.5 dB (0 to -85 dB), ± 1.0 dB (0 to -90 dB) Linear scale: ± 4 % of reference level Marker level resolution Log scale: 0.01 dB Linear scale: 0.02 % of reference level
	Spurious response	2nd harmonic distortion: ≤ -60 dBc (10 to 200 MHz, band 0, mixer level: -30 dBm) ≤ -75 dBc (0.2 to 1.3 GHz, band 0, mixer level: -30 dBm) ≤ -70 dBc (1.3 to 1.55 GHz, band 0, mixer level: -30 dBm) ≤ -80 dBc (0.8 to 1 GHz, mixer level: -30 dBm) ≤ -100 dBc (1.46 to 4.05 GHz, band 1, mixer level: -20 dBm) 3rd order intermodulation distortion: ≤ -70 dBc (10 MHz to 100 MHz frequency difference of two signals: ≥ 50 kHz, mixer level: -30 dBm) ≤ -80 dBc (0.1 to 8.1 GHz frequency difference of two signals: ≥ 50 kHz, mixer level: -30 dBm) Image response: ≤ -70 dBc Multiple response: ≤ -70 dBc
	1 dB gain compression	≥ -5 dBm (≥ 100 MHz, at mixer input level)
	Maximum dynamic range	1 dB gain compression level vs. average noise level: > 110 dB (100 MHz to 1 GHz, band 0) $> 110 - f[\text{GHz}] \text{ dB}$ (1 to 3.1 GHz, band 0) $> 110 - 0.5f[\text{GHz}] \text{ dB}$ (2.92 to 8.1 GHz, band 1) Distortion characteristics (1 kHz RBW) 2nd harmonic: > 72.5 dB (10 to 200 MHz) > 80 dB (200 to 500 MHz) $> 80 - 0.75f[\text{GHz}] \text{ dB}$ (0.5 to 1.3 GHz, band 0) $> 82.5 - 0.75f[\text{GHz}] \text{ dB}$ (0.8 to 1 GHz, band 0) $> 77.5 - 0.75f[\text{GHz}] \text{ dB}$ (1.3 to 1.55 GHz, band 0) $> 97.5 - 0.25f[\text{GHz}] \text{ dB}$ (1.46 to 4.05 GHz, band 1) 3rd order intermodulation: > 80 dB (10 to 100 MHz) > 83.3 dB (0.1 to 1 GHz) $> 83.3 - f[\text{GHz}] \text{ dB}$ (1 to 3.1 GHz, band 0) $> 83.3 - (1/3)f[\text{GHz}] \text{ dB}$ (1.46 to 8.1 GHz, band 1)
	1 dB gain compression	≥ -5 dBm (≥ 100 MHz, at mixer input level)
Sweep	Sweep time	Setting range: 20 ms to 1000 s (manually settable, or automatically settable according to span, resolution bandwidth and video bandwidth) Accuracy: ± 15 % (20 ms to 100 s), ± 45 % (110 s to 1000 s), ± 1 % (digital zero span mode)
	Sweep mode	Continuous, single
	Sweep mode in time domain	Analog zero span, digital zero span
	Zone sweep	Sweeps only in frequency range indicated by zone marker
	Tracking sweep	Sweeps while tracking peak points within zone marker (zone sweep also possible)
Functions	Numbers of points	501
	Detection mode	NORMAL: Simultaneously displays max. and min. points between sample points POS PEAK: Displays max. point between sample points NEG PEAK: Displays min. point between sample points SAMPLE: Displays momentary value at sample points Detection mode switching uncertainty: ± 0.5 dB (at reference level)
	Display	Color TFT-LCD, Size 5.5", Number of colors: 17 (RGB, each 64-scale settable), Brightness: 5-steps settable
	Display function	Trace A: Displays frequency spectrum Trace B: Displays frequency spectrum Trace Time: Displays time domain waveform at center frequency Trace A/B: Displays Trace A and Trace B simultaneously, simultaneous sweep of same frequency, alternate sweep of independent frequencies Trace A/BG: Display frequency region to be observed (background) and object band (foreground) selected from background with zone marker simultaneously, alternate sweep Trace A/Time: Displays frequency spectrum and time domain waveform at center frequency simultaneously Trace move/calculation: A \rightarrow B, B \rightarrow A, A \leftrightarrow B, A + B \rightarrow A, A - B + DL \rightarrow A
	Storage functions	NORMAL, VIEW, MAX HOLD, AVERAGE, CUMULATIVE, OVERWRITE

(Continued)

Model	MS2663C	
Functions	<p>FM demodulation waveform display</p> <p>Setting range: 2, 5, 10, 20, 50, 100, 200 kHz/div Accuracy: $\pm 5\%$ of full scale (referenced to center frequency after calibration, DC-coupled, RBW 3 MHz, VBW 1 Hz, CW) Frequency response (3 dB): DC (50 Hz at AC coupled) to 100 kHz (range ≤ 20 kHz/div, VBW off), DC (50 Hz at AC coupled) to 500 kHz (range ≥ 50 kHz/div, VBW off) *Usable RBW: ≥ 1 kHz</p>	
	Signal search	AUTO TUNE, PEAK \rightarrow CF, PEAK \rightarrow REF, SCROLL
	Zone marker	NORMAL, DELTA
	Marker	MARKER \rightarrow CF, MARKER \rightarrow REF, MARKER \rightarrow CF STEP SIZE, Δ MARKER \rightarrow SPAN, ZONE \rightarrow SPAN
	Peak search	PEAK, NEXT PEAK, NEXT RIGHT PEAK, NEXT LEFT PEAK, MIN DIP, NEXT DIP
	Multi-marker	Numbers of markers: 10 max. (HIGHEST 10, HARMONICS, MANUAL SET)
	Measure	Noise power (dBm/Hz, dBm/ch), C/N (dBc/Hz, dBc/ch), channel power (dBm, dBm/Hz), occupied bandwidth (power method, X-dB down method), adjacent channel leakage power (REF: total power method, REF: reference level method, REF: inband method, channel designate display: 2 channels \times 2, graphic display), average power of burst signal (average power in designate time range of time domain waveform), template comparison (upper/lower limits \times each 2, time domain), MASK (upper/lower limits \times each 2, frequency domain)
	Save/recall	Save and recall setting conditions and waveform data to internal memory (max. 12) or memory card
	Hard copy	Printer (HP dotmatrix, EPSON dotmatrix or compatible model): Display data can be hard-copied via the RS232C, GPIB, or Centronics (Option 10) interface Plotter (HP-GL, GP-GL compatible models): Display data can be hard-copied via the RS232C or GPIB interface
	PTA	Language: PTL (interpreter based on BASIC) Programming: Using editor of external computer Programming memory: Memory card, upload/download to/from external computer Programming capacity: 192 kbytes Data processing: Directly accesses measurement data according to system variables, system subroutines, and system functions
	RS-232C	Output data to printer or plotter. Control from external computer (excluding power switch)
	GPIB interface	Functions: Meets IEEE488.2, Can be controlled as device from external controller (excluding power switch), or can control external equipment as controller Interface functions: SH1, AH1, T6, L4, SR1, RL1, PP0, DC1, DT1, C1, C2, C3, C4, C28
	Memory card interface	Functions: Save/recall measurement settings and data, uploads/downloads PTA programs, access SRAM, EPROM and flash EEPROM (can write to SRAM only), Supports cards up to 2 MB Connector: PCMCIA Ver.2.0 2 slots Autocorrection of MA1621A impedance transformer insertion loss
Correction	Correction accuracy (input attenuator: ≥ 10 dB): ± 2.5 dB (9 to 100 kHz), ± 1.5 dB (100 kHz to 2 GHz), ± 2.0 dB ¹ (2 to 3 GHz) Antenna factor Indication of the correction waveform data by antenna factor of a designated antenna and measurement of field strength (dB μ V/m) Built-in antenna factor Dipole antenna: MP534A/MP651A Log-Periodic Antenna: MP635A/MP666A Loop Antenna: MP414B User: Programmable through GPIB or RS-232C or PTA (4 types) Saving/Loading to/from Memory card possible	
Others	Conducted emission	Meets the EN55011 (Group 1, Class A)
	Radiated emission	Meets the EN55011 (Group 1, Class A)
	Static discharge	Meets the EN50082-1
	Radiation field	Meets the EN50082-1
	Conducted susceptibility	Meets the IEC801-4 (Level II)
	Vibration	Meets the MIL-STD-810D
	Power (operating range)	85 to 132 / 170 to 250 V (automatic voltage switching), 47.5 to 63 Hz/380 to 420 Hz (85 to 132 V only), ≤ 330 VA
	Dimensions and mass	320 (W) \times 177 (H) \times 351 (D), ≤ 13.5 kg (without option)
Ambient temperature	0° to 50°C (operate), -40° to +75°C (storage)	

● **Option 01: Reference crystal oscillator**

Frequency	10 MHz
Aging rate	$\leq 1 \times 10^7$ /year, $\leq 2 \times 10^4$ /day (referenced to 24 hours warmup)
Temperature stability	$\leq 5 \times 10^7$ (0° to 50°C , referenced to 25°C)
Buffered output	BNC connector, 10 MHz, >2 V _{p-p} (200 Ω terminated)

● **Option 02: Narrow resolution bandwidth**

Resolution bandwidth (3 dB)	30 Hz, 100 Hz, 300 Hz
Resolution bandwidth switching uncertainty	± 0.4 dB (referenced to 3 kHz)
Bandwidth accuracy (MS2661C/MS2663C only)	± 20 % (RBW=100 Hz, 300 Hz)
Selectivity (60 dB:3 dB)	$\leq 15:1$ (RBW=100 Hz, 300 Hz) $\leq 20:1$ (RBW=30 Hz)

● **Option 04: High-speed time domain sweep**

Sweep time	12.5 μs , 25 μs , 50 μs , 100 to 900 μs (one most significant digit settable) 1.0 to 19 mS (two upper significant digits settable)
Accuracy	± 1 %
Marker readout resolution	Log scale: 0.1 dB Linear scale: 0.2 % of Reference Level

● **Option 06: Trigger/gate circuit**

Trigger switch	FREERUN, TRIGGERED	
Trigger source	EXT	Trigger level: ± 10 V (Resolution: 0.1 V) Trigger slope: RISE/FALL Connector: BNC
	VIDEO	Trigger level: -100 to 0 dB (Log scale, resolution 1 dB) Trigger slope: RISE/FALL
	WIDE IF VIDEO	Trigger level: High, Middle, or Low selectable Bandwidth: ≥ 20 MHz Trigger slope: RISE/FALL
	LINE	Frequency: 47.5 to 63 Hz (Line lock)
TV	System: M-NTSC, B/G/H PAL Sync: V-SYNC, H-SYNC (ODD/EVEN) Sync line: NTSC: H-SYNC (ODD): Line 7 to 262 H-SYNC (EVEN): Line 1 to 263 PAL: H-SYNC (ODD): Line 1 to 312 H-SYNC (EVEN): Line 317 to 625 *Option 16, 21 required	
Trigger delay	Pre-trigger	Displays waveform from previous max. 1 screen at trigger occurrence point Range: -Time Span to 0S Resolution: Time Span/500
	Post-trigger	Displays waveform from after max. 65.5 mS at trigger occurrence point Range: 0 to 65.5 mS Resolution: 1 μs
Gate sweep	In frequency domain, displays spectrum of input signal in specified gate interval Gate delay: 0 to 65.5 mS (from trigger point, resolution: 1 μs) Gate width: 2 μs to 65.5 mS (from gate delay point, or external control resolution: 1 μs)	

● **Option 07: AM/FM demodulator (Sound monitor)**

Sound output	When internal loud speaker and earphone connector ($\Phi 3.5$ mini jack), adjustable volume
--------------	--

● Option 08: Pre-amplifier

Model	MS2651B/61B/61C	MS2663C
Frequency range	100 kHz to 3 GHz	
Gain	20 dB ±2 dB (after calibration)	
Noise figure	≤7 dB (<2 GHz), ≤12 dB (≥2 GHz, typical value)	
Amplitude Level measurement Measurement range Maximum input level Average noise level	Average noise level to 10 dBm +10 dBm (CW average power, input attenuator ≥10 dB), ±50 Vdc MS2651B: ≤-130 dBm (1 MHz to 1 GHz) ≤-130 dBm +1.5f[GHz]dB (>1 GHz) MS2661B/C: ≤-134 dBm (1 MHz to 1 GHz) ≤-134 dBm +2f[GHz]dB (>1 GHz) *Resolution bandwidth 1 kHz, Video bandwidth 1 Hz, Input attenuator 0 dB	≤-132 dBm (1 MHz to 1 GHz) ≤-132 dBm +2f[GHz]dB (>1 GHz) *Resolution bandwidth 1 kHz, Video bandwidth 1 Hz, Input attenuator 0 dB
Reference Level	Setting range Log scale: -120 to +10 dBm, or equivalent level Linear scale: 22.4 μV to 707 mV Reference Level accuracy: ±0.5 dB (-69.9 to -20 dBm), ±0.75 dB (-89.9 to -70 dBm, -19.9 to +10 dBm) *After calibration, at frequency 100 MHz, Span 1 MHz. (When Input attenuator, Resolution bandwidth, Video bandwidth and Sweep time set to AUTO.) Resolution bandwidth switching uncertainty: ±0.5 dB *After calibration, referenced to resolution bandwidth 3 kHz Input attenuator switching uncertainty: ±0.5 dB (0 to 50 dB), ±1 dB (0 to 70 dB) *After calibration, frequency 100 MHz, referenced to attenuation 10 dB	
Frequency response	±2.0 dB (100 kHz to 3 GHz, referenced to 100 MHz, Input attenuator 10 dB to 50 dB)	
Scale Fidelity	Log scale: ±0.5 dB (0 to -20 dB) ±1 dB (0 to -60 dB), ±0.5 dB (0 to -75 dB) Linear scale: ±5 % of Reference Level	
Spurious response	3rd order intermodulation distortion: ≤-70 dBc (10 MHz to 3 GHz) *Frequency difference of two signals ≥50 kHz, pre-amplifier input level -55 dBm	
1-dB gain compression	≥-35 dBm (≥100 MHz, pre-amplifier input level)	

● Option 10: Centronics interface

Function	Output data to printer (Centronics standard)
Connector	D-sub 25-pins (jack)

● Option 12: QP detector* (MS2661B/MS2663B/MS2661C/MS2663C only)

Function	QP detector When this option is mounted, RBW=100 Hz 3 dB bandwidth of Option02 is modified to 150 Hz (representative value) for MS2661B/MS2663B.																																												
6 dB Bandwidth	Bandwidth: 200 Hz, 9 kHz, 120 kHz Accuracy: $\pm 3.0\%$ (18° to 28°C)																																												
Display	Log scale, 5 dB/div, 10 scale marks Linearity: ≤ 2.0 dB/0 to -40 dB (CW signal, Reference Level=-60 dB μ V, Input attenuator=0 dB, 18° to 28°C)																																												
Pulse response	Response corresponding to CISPR pulse (at DET mode: QP, 18° to 28°C) <table border="1"> <thead> <tr> <th colspan="2">Repetition Frequency</th> <th>Response</th> </tr> </thead> <tbody> <tr> <td rowspan="6">120 kHz Bandwidth</td> <td>1 kHz</td> <td>-8.0 dB\pm1.0 dB</td> </tr> <tr> <td>100 Hz</td> <td>Reference</td> </tr> <tr> <td>20 Hz</td> <td>+9.0 dB\pm1.0 dB</td> </tr> <tr> <td>10 Hz</td> <td>+14.0 dB\pm1.5 dB</td> </tr> <tr> <td>2 Hz</td> <td>+26.0 dB\pm2.0 dB</td> </tr> <tr> <td>1 Hz</td> <td>+28.5 dB\pm2.0 dB</td> </tr> <tr> <td rowspan="6">9 kHz Bandwidth</td> <td>1 kHz</td> <td>-4.5 dB\pm1.0 dB</td> </tr> <tr> <td>100 Hz</td> <td>Reference</td> </tr> <tr> <td>20 Hz</td> <td>+6.5 dB\pm1.0 dB</td> </tr> <tr> <td>10 Hz</td> <td>+10.0 dB\pm1.5 dB</td> </tr> <tr> <td>2 Hz</td> <td>+20.5 dB\pm2.0 dB</td> </tr> <tr> <td>1 Hz</td> <td>+22.5 dB\pm2.0 dB</td> </tr> <tr> <td rowspan="8">200 Hz Bandwidth</td> <td>100 Hz</td> <td>-4.0 dB\pm1.0 dB</td> </tr> <tr> <td>60 Hz</td> <td>-3.0 dB\pm1.0 dB</td> </tr> <tr> <td>25 Hz</td> <td>Reference</td> </tr> <tr> <td>10 Hz</td> <td>+4.0 dB\pm1.0 dB</td> </tr> <tr> <td>5 Hz</td> <td>+7.5 dB\pm1.5 dB</td> </tr> <tr> <td>2 Hz</td> <td>+13.0 dB\pm2.0 dB</td> </tr> <tr> <td>1 Hz</td> <td>+17.0 dB\pm2.0 dB</td> </tr> </tbody> </table>	Repetition Frequency		Response	120 kHz Bandwidth	1 kHz	-8.0 dB \pm 1.0 dB	100 Hz	Reference	20 Hz	+9.0 dB \pm 1.0 dB	10 Hz	+14.0 dB \pm 1.5 dB	2 Hz	+26.0 dB \pm 2.0 dB	1 Hz	+28.5 dB \pm 2.0 dB	9 kHz Bandwidth	1 kHz	-4.5 dB \pm 1.0 dB	100 Hz	Reference	20 Hz	+6.5 dB \pm 1.0 dB	10 Hz	+10.0 dB \pm 1.5 dB	2 Hz	+20.5 dB \pm 2.0 dB	1 Hz	+22.5 dB \pm 2.0 dB	200 Hz Bandwidth	100 Hz	-4.0 dB \pm 1.0 dB	60 Hz	-3.0 dB \pm 1.0 dB	25 Hz	Reference	10 Hz	+4.0 dB \pm 1.0 dB	5 Hz	+7.5 dB \pm 1.5 dB	2 Hz	+13.0 dB \pm 2.0 dB	1 Hz	+17.0 dB \pm 2.0 dB
Repetition Frequency		Response																																											
120 kHz Bandwidth	1 kHz	-8.0 dB \pm 1.0 dB																																											
	100 Hz	Reference																																											
	20 Hz	+9.0 dB \pm 1.0 dB																																											
	10 Hz	+14.0 dB \pm 1.5 dB																																											
	2 Hz	+26.0 dB \pm 2.0 dB																																											
	1 Hz	+28.5 dB \pm 2.0 dB																																											
9 kHz Bandwidth	1 kHz	-4.5 dB \pm 1.0 dB																																											
	100 Hz	Reference																																											
	20 Hz	+6.5 dB \pm 1.0 dB																																											
	10 Hz	+10.0 dB \pm 1.5 dB																																											
	2 Hz	+20.5 dB \pm 2.0 dB																																											
	1 Hz	+22.5 dB \pm 2.0 dB																																											
200 Hz Bandwidth	100 Hz	-4.0 dB \pm 1.0 dB																																											
	60 Hz	-3.0 dB \pm 1.0 dB																																											
	25 Hz	Reference																																											
	10 Hz	+4.0 dB \pm 1.0 dB																																											
	5 Hz	+7.5 dB \pm 1.5 dB																																											
	2 Hz	+13.0 dB \pm 2.0 dB																																											
	1 Hz	+17.0 dB \pm 2.0 dB																																											
	QP ON/OFF	$\leq \pm 1.0$ dB (PEAK, QP)																																											
Switching uncertainty	(CW signal, at Reference Level to -40 dB, at 18° to 28°C after automatic calibration)																																												
Detection mode	QP, AVERAGE																																												
Field Strength Measurement	Indication of the correction of waveform data by antenna factor of a designated antenna and measurement of field strength (dB μ V/m). Built-in Antenna factor Dipole Antenna : MP534A/MP651A Log-Periodic Antenna : MP635A/MP666A Loop Antenna : MP414B Use : Programmable through GPIB or RS232C (4 types) Saving/Loading to/from Memory Card possible																																												

* Used of Option02 at the same time is necessary

● Option 13: QP detector* (MS2651B/MS2653B only)

Function	QP detector																													
6 dB Bandwidth	Bandwidth: 9 kHz, 120 kHz Accuracy: $\pm 30\%$ (18° to 28°C)																													
Display	Log scale, 5dB/div, 10 scale marks Linearity: ≤ 2.0 dB/0 to -40 dB (CW signal, Reference Level = -60 dB μ V, Input attenuator = 0 dB, 18° to 28°C)																													
Pulse response	Response corresponding to CISPR pulse (at DET mode: QP, 18° to 28°C) <table border="1"> <thead> <tr> <th colspan="2">Repetition Frequency</th> <th>Response</th> </tr> </thead> <tbody> <tr> <td rowspan="6">120 kHz Bandwidth</td> <td>1 kHz</td> <td>-8.0 dB \pm 1.0 dB</td> </tr> <tr> <td>100 Hz</td> <td>Reference</td> </tr> <tr> <td>20 Hz</td> <td>+9.0 dB \pm 1.0 dB</td> </tr> <tr> <td>10 Hz</td> <td>+14.0 dB \pm 1.5 dB</td> </tr> <tr> <td>2 Hz</td> <td>+26.0 dB \pm 2.0 dB</td> </tr> <tr> <td>1 Hz</td> <td>+28.5 dB \pm 2.0 dB</td> </tr> <tr> <td rowspan="6">9 kHz Bandwidth</td> <td>1 kHz</td> <td>-4.5 dB \pm 1.0 dB</td> </tr> <tr> <td>100 Hz</td> <td>Reference</td> </tr> <tr> <td>20 Hz</td> <td>+6.5 dB \pm 1.0 dB</td> </tr> <tr> <td>10 Hz</td> <td>+10.0 dB \pm 1.5 dB</td> </tr> <tr> <td>2 Hz</td> <td>+20.5 dB \pm 2.0 dB</td> </tr> <tr> <td>1 Hz</td> <td>+22.5 dB \pm 2.0 dB</td> </tr> </tbody> </table>	Repetition Frequency		Response	120 kHz Bandwidth	1 kHz	-8.0 dB \pm 1.0 dB	100 Hz	Reference	20 Hz	+9.0 dB \pm 1.0 dB	10 Hz	+14.0 dB \pm 1.5 dB	2 Hz	+26.0 dB \pm 2.0 dB	1 Hz	+28.5 dB \pm 2.0 dB	9 kHz Bandwidth	1 kHz	-4.5 dB \pm 1.0 dB	100 Hz	Reference	20 Hz	+6.5 dB \pm 1.0 dB	10 Hz	+10.0 dB \pm 1.5 dB	2 Hz	+20.5 dB \pm 2.0 dB	1 Hz	+22.5 dB \pm 2.0 dB
Repetition Frequency		Response																												
120 kHz Bandwidth	1 kHz	-8.0 dB \pm 1.0 dB																												
	100 Hz	Reference																												
	20 Hz	+9.0 dB \pm 1.0 dB																												
	10 Hz	+14.0 dB \pm 1.5 dB																												
	2 Hz	+26.0 dB \pm 2.0 dB																												
	1 Hz	+28.5 dB \pm 2.0 dB																												
9 kHz Bandwidth	1 kHz	-4.5 dB \pm 1.0 dB																												
	100 Hz	Reference																												
	20 Hz	+6.5 dB \pm 1.0 dB																												
	10 Hz	+10.0 dB \pm 1.5 dB																												
	2 Hz	+20.5 dB \pm 2.0 dB																												
	1 Hz	+22.5 dB \pm 2.0 dB																												
QP ON/OFF	$\leq \pm 1.0$ dB (PEAK, QP)																													
Switching uncertainty	(CW signal, at Reference Level to -40 dB, at 18° to 28°C after automatic calibration)																													
Detection mode	QP, AVERAGE																													
Field Strength Measurement	Indication of the correction of waveform data by antenna factor of a designated antenna and measurement of field strength (dB μ V/m). Built-in Antenna factor Dipole Antenna : MP534A/MP651A Log-Periodic Antenna : MP635A/MP666A Loop Antenna : MP414B User : Programmable through GPIB or RS232C (4 types) Saving/Loading to/from Memory Card possible																													

● **Option 14: PTA PARALLEL I/O***

Function	Controlling external equipment from PTA																																																																												
System variables	The following controls are possible using PTA system variables: <table border="1" data-bbox="630 351 1242 549"> <thead> <tr> <th>System variable</th> <th>Control description</th> </tr> </thead> <tbody> <tr> <td>IOA</td> <td>Control of 8 bits parallel output port A</td> </tr> <tr> <td>IOB</td> <td>Control of 8 bits parallel output port B</td> </tr> <tr> <td>IOC</td> <td>Control of 8 bits parallel I/O port C</td> </tr> <tr> <td>IOD</td> <td>Control of 8 bits parallel I/O port D</td> </tr> <tr> <td>EIO</td> <td>Control of I/O switching port C and D</td> </tr> <tr> <td>EXO</td> <td>Control of trigger (I/O)</td> </tr> </tbody> </table>	System variable	Control description	IOA	Control of 8 bits parallel output port A	IOB	Control of 8 bits parallel output port B	IOC	Control of 8 bits parallel I/O port C	IOD	Control of 8 bits parallel I/O port D	EIO	Control of I/O switching port C and D	EXO	Control of trigger (I/O)																																																														
System variable	Control description																																																																												
IOA	Control of 8 bits parallel output port A																																																																												
IOB	Control of 8 bits parallel output port B																																																																												
IOC	Control of 8 bits parallel I/O port C																																																																												
IOD	Control of 8 bits parallel I/O port D																																																																												
EIO	Control of I/O switching port C and D																																																																												
EXO	Control of trigger (I/O)																																																																												
PTL statements	Using PTA PTL statements allows control of interrupts input externally to the I/O ports <table border="1" data-bbox="630 627 1242 798"> <thead> <tr> <th>PTL statement</th> <th>Control description</th> </tr> </thead> <tbody> <tr> <td>IOEN statement</td> <td>Allow interrupt input</td> </tr> <tr> <td>IODI statement</td> <td>Prohibit interrupt input</td> </tr> <tr> <td>IOMA statement</td> <td>Masks interrupt input</td> </tr> <tr> <td>ON TO GOTO statement</td> <td>Changes program flow when interrupt occurs</td> </tr> <tr> <td>ON TO GOSUB statement</td> <td>Changes program flow when interrupt occurs</td> </tr> </tbody> </table>	PTL statement	Control description	IOEN statement	Allow interrupt input	IODI statement	Prohibit interrupt input	IOMA statement	Masks interrupt input	ON TO GOTO statement	Changes program flow when interrupt occurs	ON TO GOSUB statement	Changes program flow when interrupt occurs																																																																
PTL statement	Control description																																																																												
IOEN statement	Allow interrupt input																																																																												
IODI statement	Prohibit interrupt input																																																																												
IOMA statement	Masks interrupt input																																																																												
ON TO GOTO statement	Changes program flow when interrupt occurs																																																																												
ON TO GOSUB statement	Changes program flow when interrupt occurs																																																																												
Write strobe signal	Outputs a write strobe pulse (negative pulse) to an external unit when output port C or D is controlled																																																																												
DC output	Supplies +5 V \pm 0.5 V (max. 100 mA) power for external equipment use																																																																												
Signal logical level	Negative logic, TTL level Rated current: Output ports A, B:Max.output current Hi: 2.6 mA, Lo: 24 mA Output ports C, D:Max.output current Hi: 15 mA, Lo: 24 mA Other control output lines :Max. output current Hi: 0.4 mA, Lo: 8 mA																																																																												
Cable connector	Amphenol 36 pins																																																																												
Connector pin layout	<table border="1" data-bbox="630 1064 1198 1606"> <thead> <tr> <th>Pin No.</th> <th>Name</th> <th>Pin No.</th> <th>Name</th> </tr> </thead> <tbody> <tr><td>1</td><td>GND</td><td>19</td><td>Output port B (6)</td></tr> <tr><td>2</td><td>Trigger input</td><td>20</td><td>Output port B (7) MSB</td></tr> <tr><td>3</td><td>Trigger output1</td><td>21</td><td>I/O port C (0) LSB</td></tr> <tr><td>4</td><td>Trigger output2</td><td>22</td><td>I/O port C (1)</td></tr> <tr><td>5</td><td>Output port A (0) LSB</td><td>23</td><td>I/O port C (2)</td></tr> <tr><td>6</td><td>Output port A (1)</td><td>24</td><td>I/O port C (3) MSB</td></tr> <tr><td>7</td><td>Output port A (2)</td><td>25</td><td>I/O port D (0) LSB</td></tr> <tr><td>8</td><td>Output port A (3)</td><td>26</td><td>I/O port D (1)</td></tr> <tr><td>9</td><td>Output port A (4)</td><td>27</td><td>I/O port D (2)</td></tr> <tr><td>10</td><td>Output port A (5)</td><td>28</td><td>I/O port D (3) MSB</td></tr> <tr><td>11</td><td>Output port A (6)</td><td>29</td><td>Port C status 0/1:I/O</td></tr> <tr><td>12</td><td>Output port A (7) MSB</td><td>30</td><td>Port D status 0/1:I/O</td></tr> <tr><td>13</td><td>Output port B (0) LSB</td><td>31</td><td>Write strobe signal</td></tr> <tr><td>14</td><td>Output port B (1)</td><td>32</td><td>Interrupt signal</td></tr> <tr><td>15</td><td>Output port B (2)</td><td>33</td><td>(not used)</td></tr> <tr><td>16</td><td>Output port B (3)</td><td>34</td><td>+5 V power supply</td></tr> <tr><td>17</td><td>Output port B (4)</td><td>35</td><td>(not used)</td></tr> <tr><td>18</td><td>Output port B (5)</td><td>36</td><td>(not used)</td></tr> </tbody> </table>	Pin No.	Name	Pin No.	Name	1	GND	19	Output port B (6)	2	Trigger input	20	Output port B (7) MSB	3	Trigger output1	21	I/O port C (0) LSB	4	Trigger output2	22	I/O port C (1)	5	Output port A (0) LSB	23	I/O port C (2)	6	Output port A (1)	24	I/O port C (3) MSB	7	Output port A (2)	25	I/O port D (0) LSB	8	Output port A (3)	26	I/O port D (1)	9	Output port A (4)	27	I/O port D (2)	10	Output port A (5)	28	I/O port D (3) MSB	11	Output port A (6)	29	Port C status 0/1:I/O	12	Output port A (7) MSB	30	Port D status 0/1:I/O	13	Output port B (0) LSB	31	Write strobe signal	14	Output port B (1)	32	Interrupt signal	15	Output port B (2)	33	(not used)	16	Output port B (3)	34	+5 V power supply	17	Output port B (4)	35	(not used)	18	Output port B (5)	36	(not used)
Pin No.	Name	Pin No.	Name																																																																										
1	GND	19	Output port B (6)																																																																										
2	Trigger input	20	Output port B (7) MSB																																																																										
3	Trigger output1	21	I/O port C (0) LSB																																																																										
4	Trigger output2	22	I/O port C (1)																																																																										
5	Output port A (0) LSB	23	I/O port C (2)																																																																										
6	Output port A (1)	24	I/O port C (3) MSB																																																																										
7	Output port A (2)	25	I/O port D (0) LSB																																																																										
8	Output port A (3)	26	I/O port D (1)																																																																										
9	Output port A (4)	27	I/O port D (2)																																																																										
10	Output port A (5)	28	I/O port D (3) MSB																																																																										
11	Output port A (6)	29	Port C status 0/1:I/O																																																																										
12	Output port A (7) MSB	30	Port D status 0/1:I/O																																																																										
13	Output port B (0) LSB	31	Write strobe signal																																																																										
14	Output port B (1)	32	Interrupt signal																																																																										
15	Output port B (2)	33	(not used)																																																																										
16	Output port B (3)	34	+5 V power supply																																																																										
17	Output port B (4)	35	(not used)																																																																										
18	Output port B (5)	36	(not used)																																																																										

* Not installed with Option10: Centronics interface

● **Option 15: Sweep signal output**

Sweep output (X)	0 to 10 V \pm 1 V (\geq 100 k Ω termination, from left side to right side of display scale), BNC connector
Sweep status output (Z)	TTL level (low level with sweeping), BNC connector

● Option 16: Television monitor

Video	M-NTSC, B/G/H PAL color	
Audio	Simultaneous monitor of video and audio needs Option07: AM/FM demodulator	
Function	Channel	CCIR, USA, Italy, Japan
	Trigger	Vsync, HSYNC (ODD), HSYNC (EVEN) line
	Aux.output	Composite video, BNC connector

● Option 19: DC coupled input*

Function	DC coupling the input circuits and expanding the lower limit of reception frequency to 500 Hz	
Frequency Range	500 Hz to 3 GHz	
Amplitude	Max input level	+30 dBm (CW average power, Input attenuator ≥ 10 dB), ± 0 Vdc
	Average noise level	Resolution bandwidth: 30 Hz, Input attenuator: 0 dB, Video bandwidth: 1 Hz ≤ -80 dBm (500 Hz to 10 kHz) ≤ -90 dBm (10 kHz to 200 kHz) ≤ -110 dBm (200 kHz to 1 MHz)
	Frequency response	± 1.2 dB (500 Hz to 100 kHz) ± 0.5 dB (100 kHz to 3 GHz)

* Use Option02 at the same time is necessary

● Option 20: Tracking generator

	MS2651B/61B/61C	MS2663C (*)
Frequency range	9 kHz to 3 GHz	
Output level range	0 to -60 dBm	
Output level resolution	0.1 dB	
Output level accuracy	± 1.0 dB (at frequency 100 MHz, 0 dBm)	
Flatness	± 1.5 dB (100 kHz to 3 GHz, output level 0 dBm, referenced to 100 MHz)	
Output level linearity	± 1.0 dB (output level 0 to -30 dBm) ± 2.0 dB (output level -30 to -60 dBm) (100 kHz to 3 GHz, referenced to 0 dBm)	
Spurious	Harmonics ≤ -20 dBc (output level 0 dBm, 100 kHz to 3 GHz) Non-harmonics ≤ -35 dBc (output level 0 dBm, 100 kHz to 3 GHz)	Harmonics ≤ -20 dBc (output level 0 dBm, 100 kHz to 3 GHz) Non-harmonics ≤ -35 dBc (100 kHz to 2 GHz) ≤ -30 dBc (2 to 3 GHz) (output level 0 dBm)
Tracking generator feed through	≤ -95 dBm (RF input and TG output terminated 50 Ω)	
Output connector	N-J, 50 Ω	

(*) Not installed with Option 08: Pre-amplifier

● Option 21: Television monitor (multi-system)

Video	M-NTSC, B/G/H/D/I PAL color	
Audio	Simultaneous monitor of video and audio needs Option07: AM/FM demodulator	
Function	Channel	CCIR, USA, Italy, Japan, China, UK
	Trigger	Vsync, HSYNC (ODD), HSYNC (EVEN) line
	Aux.output	Composite video, BNC connector

● Option 22: 75 Ω Input (MS2651B/MS2661B/MS2661C only)

Model	MS2651B	MS2661B/MS2661C	
Function	75 Ω Input Selectable tracking generator is opt. 23 75 Ω Tracking generator only.		
Frequency range	100 kHz to 2.5 GHz		
Amplitude	Measurement range	Average noise level to +25 dBm	
	Maximum input level	+25 dBm (RF ATT \geq 10 dB), \pm 100 V	
	Residual response	\leq -95 dBm (+13.8 dB μ V) (RF ATT: 0 dB, Input: 75 Ω termination)	
	Total level accuracy	\pm 1.8 dB (100 kHz to 2.5 GHz, T=18 to 28°C) *Level measurement accuracy after calibration using internal calibration signal. Total level accuracy: Reference level accuracy (0 to -49.9 dBm) +Frequency response +log linearity (0 to -20 dB)	
	Reference level	Setting range Log scale: +8.8 dB μ V to +133.8 dB μ V or equivalent level Linear scale: 274 μ V to 4.87 V	
	Frequency response	\pm 1.0 dB (100 kHz to 2.5 GHz) *Referenced to 100 MHz, RF ATT=10 dB, T=18 to 28°C	
	Spurious response	2nd harmonic distortion: (Mixer level: -30 dBm) \leq -55 dBc (10 to 100 MHz) \leq -60 dBc (0.1 to 1.25 GHz)	\leq -60 dBc (10 to 200 MHz) \leq -75 dBc (0.2 to 1.25 GHz) \leq -80 dBc (0.8 to 1 GHz)
		3rd order intermodulation distortion: (Mixer level: -30 dBm, separation of two signals: \geq 50 kHz) \leq -70 dBc (10 to 2500 MHz)	\leq -70 dBc (10 to 100 MHz) \leq -80 dBc (0.1 to 2.5 GHz)
	Maximum dynamic range (RBW=1 kHz)	1 dB gain compression level to average noise level: >105 dB (0.1 to 1 GHz) >105 dB -f[GHz]dB (>1 GHz)	>110 dB (0.1 to 1 GHz) >110 dB -f[GHz]dB (>1 GHz) When opt. 08 pre-amplifier is installed >109 dB (0.1 to 1 GHz) >109 dB -1.5f[GHz]dB (>1 GHz)
		Distortion characteristics 2nd harmonic distortion: >67.5 dB (10 to 100 MHz) >70 dB (0.1 to 0.5 GHz) >70 dB -f[GHz]dB (0.5 to 1.25 GHz)	>72.5 dB (10 to 200 MHz) >80 dB (0.2 to 0.5 GHz) >80 dB -f[GHz]dB (0.5 to 1.25 GHz) >82.5 dB -f[GHz]dB (0.8 to 1 GHz)
3rd order intermodulation distortion: >76.6 dB (10 to 100 MHz) >76.6 dB -2f[GHz]/3 dB (0.1 to 1.25 GHz)		>80 dB (10 to 100 MHz) >83.3 dB (0.1 to 1 GHz) >83.3 dB -2f[GHz]/3 dB (1 to 1.25 GHz)	
Others	RF Connector	NC-J, 75 Ω	
	Video Output (Y)	Connector: BNC Level: (100 MHz Input, from lower edge to upper edge at 10 %/div and 10 dB/div, 75 Ω termination) Log scale: 0 to 0.5 V \pm 0.1 V nominal Linear scale: 0 to 0.4 V \pm 0.1 V nominal	

● **Option 23: 75 Ω Input (MS2651B/MS2661B/MS2661C only)**

Frequency range	100 kHz to 2.5 GHz
Output level	Setting range +44 dBμV to +104 dBμV Setting resolution 0.1 dB
Output level accuracy	±1.5 dB (100 MHz, +104 dBμV)
Flatness	±1.5 dB (referenced to 100 MHz, +104 dBμV)
Linearity	*referenced to +104 dBμV ≤1.0 dB (+74 dBμV) ≤2.0 dB (+44 dBμV to +74 dBμV)
Spurious	Harmonics: ≤-20 dBc Non-harmonics: ≤-30 dBc
TG feed through	≤+13.8 dBμV *RF Input and TG Output are terminated to 75 Ω termination
TG Output Connector	NC-J, 75 Ω

● **Option 24: Television monitor (Brazil)**

Video	M-NTSC, M-PAL color	
Audio	Simultaneous monitor of video and audio needs Option 07: AM/FM demodulator	
Function	Channel	CCIR, USA, Italy, Japan, China, UK
	Trigger	Vsync, HSYNC (ODD), HSYNC (EVEN) line
	Aux. output	Composite video, BNC connector

● **Whether or not to mount options on the series devices**

3 GHz Model

Option No.	Name	Model					
		50 Ω			75 Ω (Option 22)		
		MS2651B	MS2661B	MS2661C	MS2651B	MS2661B	MS2661C
01	Reference crystal oscillator	○	○	○	○	○	○
02	Narrow resolution bandwidth	×	○	○	×	○	○
04	High-speed time domain sweep	○	○	○	○	○	○
06	Trigger/gate circuit	○	○	○	○	○	○
07	AM/FM demodulator	○	○	○	○	○	○
08	Pre-amplifier	○	○	○	○	○	○
10	Centronics interface	○	○	○	○	○	○
12	QP detector (200 Hz, 9 kHz, 120 kHz)	×	○	○	×	○	○
13	QP detector (9 kHz, 120 kHz)	○	×	×	○	×	×
14	PTA parallel I/O	○	○	○	○	○	○
15	Sweep signal output	○	○	○	○	○	○
16	Television monitor	○	○	○	○	○	○
19	DC coupled input	×	○	○	×	○	○
20	Tracking generator	○	○	○	×	×	×
21	Television monitor (multi-system)	○	○	○	○	○	○
22	75 Ω input						
23	75 Ω Tracking generator	×	×	×	○	○	○
24	Television monitor (Brazil)	○	○	○	○	○	○

○: Can be mounted

×: Cannot be mounted

8 GHz Model

Option No.	Name	Model		
		50 Ω		
		MS2653B	MS2663B	MS2663C
01	Reference crystal oscillator	○	○	○
02	Narrow resolution bandwidth	×	○	○
04	High-speed time domain sweep	○	○	○
06	Trigger/gate circuit	○	○	○
07	AM/FM demodulator	○	○	○
08	Pre-amplifier	×	×	○
10	Centronics interface	○	○	○
12	QP detector (200 Hz, 9 kHz, 120 kHz)	×	○	○
13	QP detector (9 kHz, 120 kHz)	○	×	×
14	PTA parallel I/O	○	○	○
15	Sweep signal output	○	○	○
16	Television monitor	○	○	○
21	Television monitor (multi-system)	○	○	○
24	Television monitor (Brazil)	○	○	○

○: Can be mounted

×: Cannot be mounted

SECTION 2

PREPARATIONS BEFORE USE

This section explains the preparations and safety procedures that should be performed before using the MS2650/MS2660B/C series Spectrum Analyzer. The safety procedures are to prevent the risk of injury to the operator and damage to the equipment. Insure that you understand the contents of the pre-operation preparations before using the MS2650/MS2660B/C series.

For connecting the GPIB cable and setting the GPIB address, see the Remote Control part of the separate Operation Manual Vol.3.

TABLE OF CONTENTS

Installation Site and Environmental Conditions	2-3
Locations to be avoided	2-3
Fan clearance	2-3
Safety Measures	2-4
Power-on	2-4
Input level to RF Input	2-5
Installation	2-6
Rack mounting	2-6
Preparations before Power-on	2-7
Protective grounding	2-8
Replacing fuse	2-9
Precaution for Handling Memory Card	2-11

SECTION 2 PREPARATIONS BEFORE USE

Installation Site and Environmental Conditions

Locations to be avoided

The MS2650/MS2660B/C series spectrum analyzer operates normally at temperatures from 0 to 50 °C. However, for the best performance, the following locations should be avoided.

- Where there is severe vibration
- Where the humidity is high
- Where the equipment will be exposed direct sunlight
- Where the equipment will be exposed active gases

In addition to meeting the above conditions, to insure long-term trouble-free operation, the equipment should be used at room temperature and in a location where the power supply voltage does not fluctuate greatly.

CAUTION

If the MS2650/MS2660B/C series spectrum analyzer is used at normal temperatures after it has been used or stored for a long time at low temperatures, there is a risk of short-circuiting caused by condensation. To prevent this risk, do not turn the MS2650/MS2660B/C series on until it has been allowed to dry out sufficiently.

Fan clearance

To suppress any internal temperature increase, the MS2650/MS2660B/C series has a fan on the rear panel as shown in the diagram below. Leave a gap of at least 10 cm between the rear panel and the wall, nearby equipment or obstructions so that fan ventilation is not blocked.

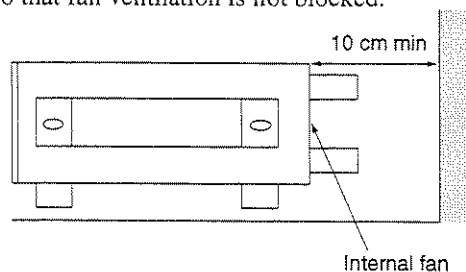

Safety Measures

This paragraph explains the safety procedures which should be followed under all circumstances not to counter the risk of an accidental electric shock, damage to the equipment or a major operation interruption.

Power-on

WARNING

-
- Before power-on: The MS2650/MS2660B/C series spectrum analyzer must be connected to protective ground.
If the power is switched on without taking this countermeasure, there is a risk of receiving a accidental electric shock. In addition, it is essential to check the power supply voltage. If an abnormal voltage that exceeds the specified value is input, there is accidental risk of damage to the MS2650/MS2660B/C series and fire.
 - During power-on: To maintain the MS2650/MS2660B/C series, sometimes it is necessary to make internal checks and adjustments with the covers removed while power is supplied. Very-high, dangerous voltages are used in the MS2650/MS2660B/C series, if insufficient care is taken, there is a risk of a accidental electric shock being received or of damage to the equipment. To maintain the MS2650/MS2660B/C series, request service by a service personnel who has received the required training.
-

In the following, special notes on safety procedures are extracted from sections other than Section 2. To prevent accidents, read this section together with the related sections before beginning operation.

Input level to RF Input

Frequency range:	9 kHz to 3 GHz (MS2651B/2661B/2661C: standard) 9 kHz to 8.1 GHz (MS2653B/2663B/2663C)
Measurement level:	Apply the measured signal with average noise level of up to +30 dBm to the N-type connector RF Input of 50 Ω input impedance
Frequency range:	100 kHz to 2.5 GHz (MS2651B/2661B/2661C plus opt. 22 75 Ω :75 Ω)
Measurement level:	Apply the measured signal with average noise level up to +25 dBm to the NC-type connector RF Input of 75 Ω input impedance.



CAUTION

The RF Input circuit is not protected against excessive power.

If a signal exceeding +30 dBm is applied with input attenuator setting ≥ 10 dB, the input attenuator and input mixer may be burned.

When the Option-08 Preamplicifier installed and the preamplicifier ON; if a signal exceeding +10 dBm or +20 dBm is applied with input attenuator setting ≥ 0 dB or 10 dB, respectively, the input attenuator and input mixer may be burned.

When the Option 22 is installed; if a signal exceeding +25 dBm, the input attenuator and input mixer may be burned.

 is a warning mark to prevent such damage.

Installation

Rack mounting

The B0395A/0395B Rack Mount Kit (sold separately) is required to mount this unit in a rack.
The installation method is included in the rack mount kit diagram.

Preparations before Power-on

This unit operates normally when it is connected to an AC 85 to 132 V, or AC 170 to 250 V (automatic voltage change) 47.5 to 63 Hz AC power supply. To prevent the following problems, take the necessary procedures described on the following pages before power is supplied.

- Accidental electric shock
- Damage caused by abnormal voltage
- Ground current problems

Note:

- *The voltage and current rating are indicated on the rear panel when the instrument is shipped from the factory.*
- *In this manual, the power supply voltage and current ratings are represented by AC** V and *** A, respectively.*

To protect the operator, the following WARNING and CAUTION notices are attached to the rear panel of the MS2651B/MS2661B/MS2653B/MS2663B/MS2661C/MS2663C.

WARNING

NO OPERATOR SERVICE-
ABLE PARTS INSIDE.
REFER SERVICING TO
QUALIFIED PERSONNEL.

CAUTION

FOR CONTINUED FIRE
PROTECTION REPLACE
ONLY WITH SPECIFIED
TYPE AND RATED FUSE.

WARNING

Disassembly, adjustment, maintenance, or other access inside this instrument by unqualified personal should be avoided. Maintenance of this instrument should be performed only by Anritsu trained service personnel who are familiar with the risk involved of fire and electric shock. Potentially lethal voltages existing inside this instrument, if contacted accidentally, may result in personal injury or death, or in the possibility of damage to precision components.

Always follow the instructions on the following pages.

Protective grounding

(1) Grounding with 3-pole power outlet

When connecting to a 3-pole (grounded, 2-pole type) AC power-supply outlet, the frame of the MS2650/MS2660B/C series is connected to ground potential. As a result, it is not necessary to connect the FG terminal to ground.

(2) Grounding with frame ground (FG) terminal

When there is no 3-pole AC power-supply outlet, the protective frame-ground (FG) terminal on the rear panel must be connected directly to ground potential.

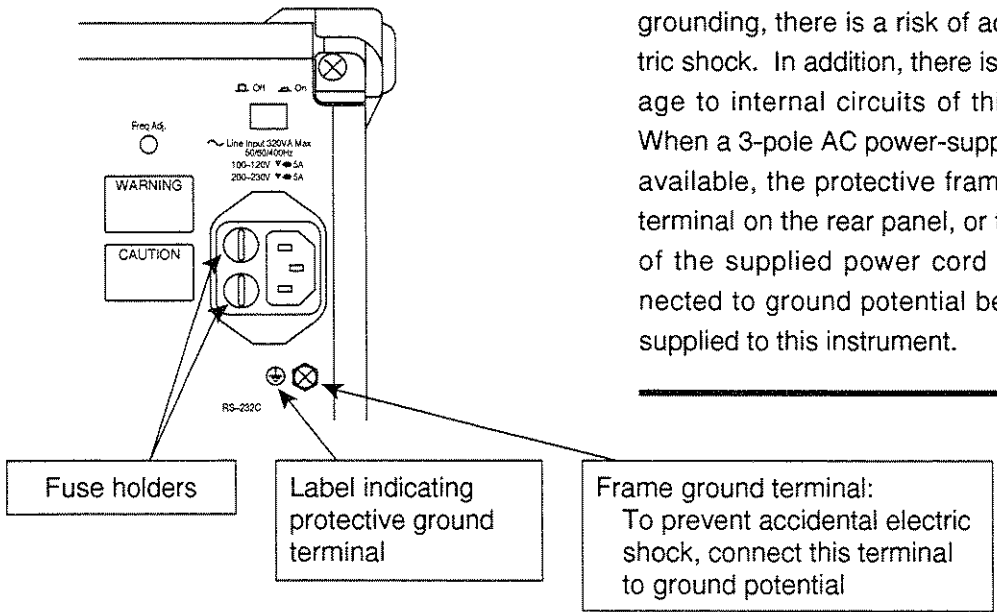

Replacing fuse

WARNING

-
- If the fuses are replaced while power is supplied, there is a serious risk of electric shock. Before replacing the fuses, set the power switch to OFF and remove the power cord from the power outlet.
 - If power is supplied without protective grounding, there is a risk of accidental electric shock. In addition, if the AC power supply voltage is unsuitable, there is a risk of the internal circuits of the MS2650/MS2660B/C series being damaged by the abnormal voltage. Before supplying power again after changing the fuses, check that the protective grounding described previously is still connected, and check that the AC power supply voltage is suitable. Then, set the power switch to ON.
-

CAUTION

When there are no supplied spare fuses, the replacement fuses must have the same rated voltage and current as the fuses in the fuse holders.

- If the replacement fuses are not of the same type, they may not fit correctly, there may be a faulty connection, or the time taken to for the fuses to blow may be too long.
 - When an abnormality occurs again, if the voltage and current rating of the fuses is incorrect, the fuses may not blow with a consequent risk of damage to the equipment by fire.
-

SECTION 2 PREPARATIONS BEFORE USE

This instrument with standard accessories has two spare 5 A fuses. The fuses are mounted in the fuse holder and must be replaced if they blow. If the fuses must be replaced, locate and remedy the cause before replacing the blown fuses.

After performing the safety procedures described on the preceding page, replace the fuses according to the following procedure.

Step	Procedure
1	Set the front-panel [Power] switch to Stby and the rear-panel [Line] switch to OFF. Then, remove the power cord from the power-supply outlet.
2	Use a flat-bladed screwdriver to turn the fuse-holder cap counterclockwise. The cap and fuse are removed as a unit from the fuse holder.
3	Remove the fuse from the fuse cap and replace it with a spare fuse. (The direction does not matter.)
4	Return the fuse cap with fuse to the fuse holder and fasten it by turning it clockwise with the flat-bladed screwdriver.

Precaution for Handling Memory Card

See para. 1.3 for the memory card to be used.

When a new memory card used to save any file, format it beforehand to MS-DOS.

When saving data to a memory card; confirm that the write-protect switch of the card is set at the NOT-PROTECTED side, and then install it to this instrument. (For the setting method, see the operation manual of the card.)

- Installing Memory Card

Install the memory card to this instrument, with the cutout of the card at the position as shown below. Two card can be installed at the upper and lower sides.

Memory Card

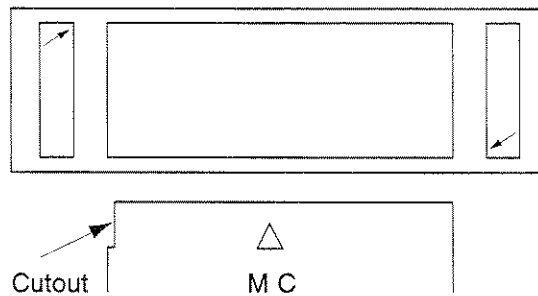

- Removing Memory Card

Push the left eject button to remove the memory card at the upper side.

Push the right eject button to remove the memory card at the lower side.

- Replacing Battery of Memory Card

Memory card has a battery. When the battery life ends, the saved data is erased. Replace the battery before the life end. (For the battery life and replacing method, see the operation manual of the card.)

SECTION 2 PREPARATIONS BEFORE USE

SECTION 3
PANEL DESCRIPTION

In this section, the front and rear panels are described about the case in which all the options are attached to.

TABLE OF CONTENTS

Table of Front and Rear Panel Features 3-3

SECTION 3 PANEL DESCRIPTION

In this section, the front and rear panels (Figs. 3-1 and 3-2) are described about the case in which all the options are attached to.

Table of Front and Rear Panel Features

No.	Panel Marking	Explanation of Function
1	(LCD)	This is a 5.5" color TFT liquid crystal display (LCD). It displays the trace waveforms, the parameter settings, the values of marker, and the soft menu keys, etc.
2	Menu On/Off	This toggles the soft-key menu display On/Off.
3	F 1 - F 6	These are the soft keys for selecting the soft-key menus linked to the panel key operation.
4	More	This displays the next page of soft-key menus.
5	Freq/Ampl	This is the frequency and level parameter data input section. [Frequency] Sets frequency. [Span] Sets frequency span. [Amplitude] Sets reference level. [-> CF] Sets peak level signal frequency on screen to center frequency. [-> RLV] Sets peak level on screen to reference level.
6	Marker	This section is related to operation of marker functions. [Marker] Sets marker. [Multi Mkr] Sets multimarkers. Press this key after pressing the [Shift] key. [Peak Search] Moves marker to currently-displayed peak level. [Marker ->] Sets parameter according to marker value. Press this key after pressing the [Shift] key.
7	User	This is a user-dedicated key which users can specify.

No.	Panel Marking	Explanation of Function
8	Single	<p>This sets the sweep mode.</p> <p>[Single] Executes single sweep.</p> <p>[Continuous] Executes continuous sweeping.</p> <p>Press this key after pressing the [Shift] key.</p> <p>The initial default is continuous sweeping.</p>
9	Recall	<p>This executes recall/save.</p> <p>[Recall] Reads measurement parameters and waveform data from internal memory or memory card.</p> <p>[Save] Saves measurement parameters and waveform data to internal memory or memory card.</p>
10	Measure	<p>This menu is for performing the various application measurements including frequency measurement, noise measurement, adjacent-channel leakage power measurement, etc.</p>
11	TG	<p>This sets the tracking generator function.</p> <p>(If Option 20/23 is not attached to, this key is not available.)</p>
12	Display	<p>This section is for selecting the trace waveform. Normally, in the frequency domain, up to two trace waveforms can be displayed. The zero-span (Time Domain) mode is selected simply by pressing the [Time] key.</p> <p>[A, B] Displays trace A or B waveform in frequency domain.</p> <p>[A/B, A/BG] Displays trace A and B waveforms simultaneously, or displays trace A and BG (background frequency spectrum including trace A) simultaneously.</p> <p>[Time] Switches to zero span (Time domain) mode to display time domain waveforms.</p> <p>[A/Time] Displays trace A and the time domain waveform simultaneously.</p>
13	Trig/Gate	<p>This sets the trigger/gate and TV-image monitoring functions.</p> <p>[Trig/Gate] Sets the sweep-start trigger and gate (to control waveform-data write timing) functions.</p> <p>[TV Monitor] Sets the TV-image monitoring function.</p>
14	Coupled Function	<p>This sets the RBW, VBW, sweep time and input attenuator.</p>

No.	Panel Marking	Explanation of Function
15	Entry	<p>These keys set the numeric data, units and special functions.</p> <p>[Rotary knob] Used for moving marker and inputting data.</p> <p>[∨, ^] Increments and decrements input data.</p> <p>[Shift] To execute panel functions indicated by blue letters, press this key and then press the blue-lettered key.</p> <p>[BS] Backspace key for correcting input mistakes.</p> <p>[0-9, ., +/-] Numeric-data setting keys.</p> <p>[GHz, MHz, kHz, Hz] Units keys for frequency, level, time, etc.</p>
16	Preset	This sets the measurement parameters to the default values.
17	Local	This changes the remote status to the local status.
18	Copy	This outputs a hard copy of the screen to a printer or plotter.
19	Stby/On	This is the power switch. It can be used when the back-panel power switch is on. The power-on condition is fetched from the Stby condition when the key is pressed for about 1 seconds. The equipment is returned to the Stby condition from the power-on condition when the key is pressed again for about 1 seconds.
20	Memory Card	This is the slot to set memory cards which save/load the waveform data and measurement parameters etc. Up to two plug-in memory card can be used.
21	RF Input	This is the RF input connector.
22	TG Output	This is the tracking generator output connector. (If Option 20/23 is not attached to, this connector is not provided.)
50	(Fan)	This is the cooling fan for ventilating internally-generated heat. Leave a clearance of at least 10 cm around the fan.
51	10 MHz STD	They are the input connector for an external reference crystal oscillator and the output connector of the 10 MHz Reference signal. When an external reference signal is input, the equipment switches automatically from the internal signal to the external signal. If Option 01 is not attached to, this connector is not provided.
52	IF OUT	This is the IF output connector. This signal is bandwidth controlled by the RBW setting.
53	Video (Y)	This connector output a Y-axis signal that is proportional to the video detection signal output and is logarithmically compressed at log scale.

No.	Panel Marking	Explanation of Function
54	Composite Out	This is the video composite signal output connector.
55	Off/On	This is the AC line power switch.
56	(Inlet)	This is the fused AC power inlet to which the supplied power cord is connected. It contains two time-lag fuses.
57	(Ground Terminal)	Connect this frame ground terminal to ground to prevent risk of an accidental electric shock.
58	RS-232C	This is the RS-232C connector. Connect it to an external system controller or printer, etc.
59	GPIB or Centronics	This connector is for use with a GPIB or Centronics (Option 10) interface. It is connected to an external system controller, or a printer etc.
60	Trig/Gate In (± 10 V)	This is a input connector for external trigger/gate signal. (If Option 06 is not attached to, this connector is not provided.)
61	Phone	This is a output connector for earphone. (If Option 07 is not attached to, this connector is not provided.)
62	Sweep (X)	This is a output connector for sweep signal (X). (If Option 15 is not attached to, this connector is not provided.)
63	Sweep Status (Z)	This is a output connector for sweep status signal (Z). (If Option 15 is not attached to, this connector is not provided.)
64	Video (TV)	This is a output connector for a demodulated signal (composite signal) by the TV monitor. (If Option 16, 21, 24 is no attached to, this connector is not provided.
65	Name plate	This shows a production number and options.

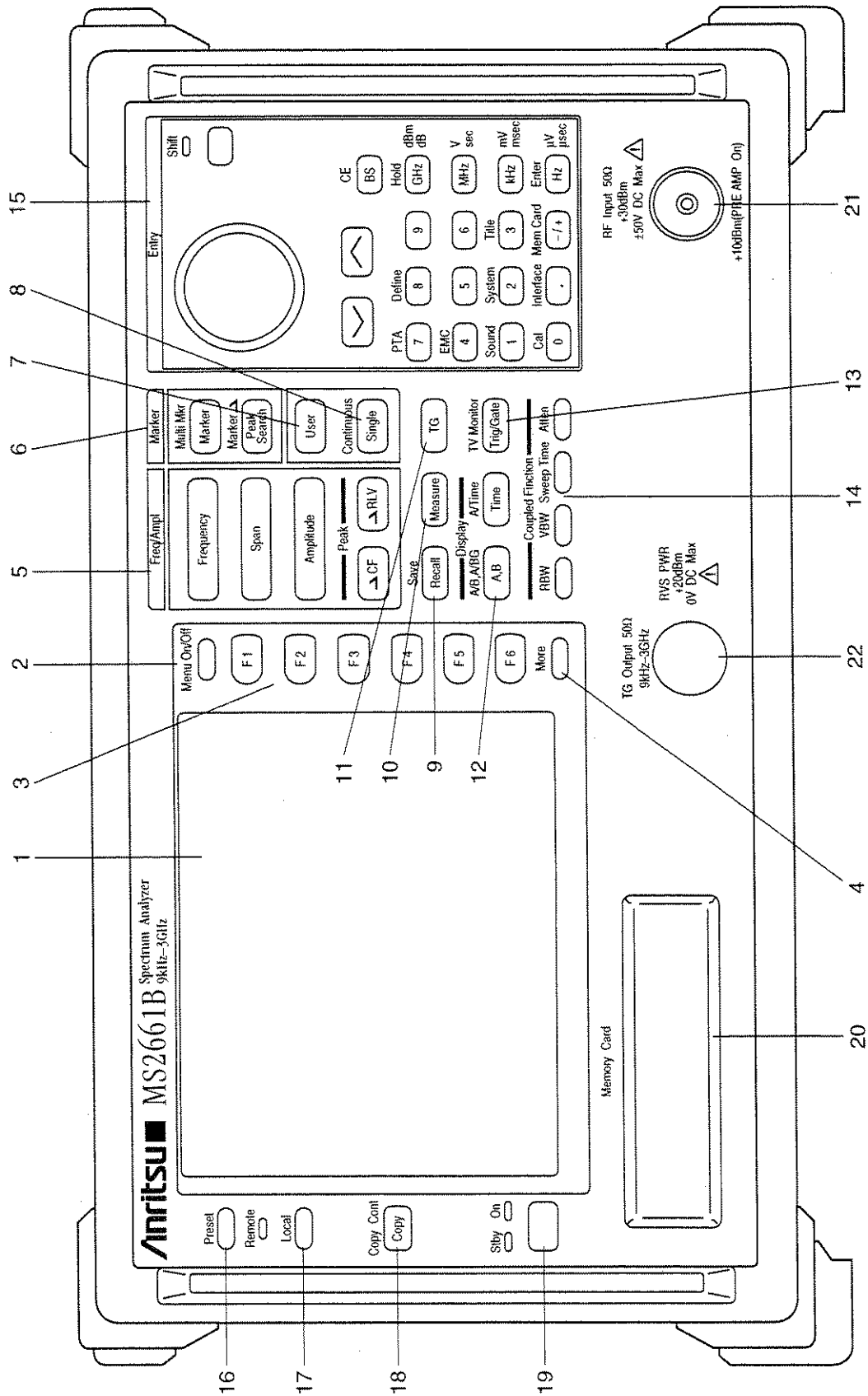
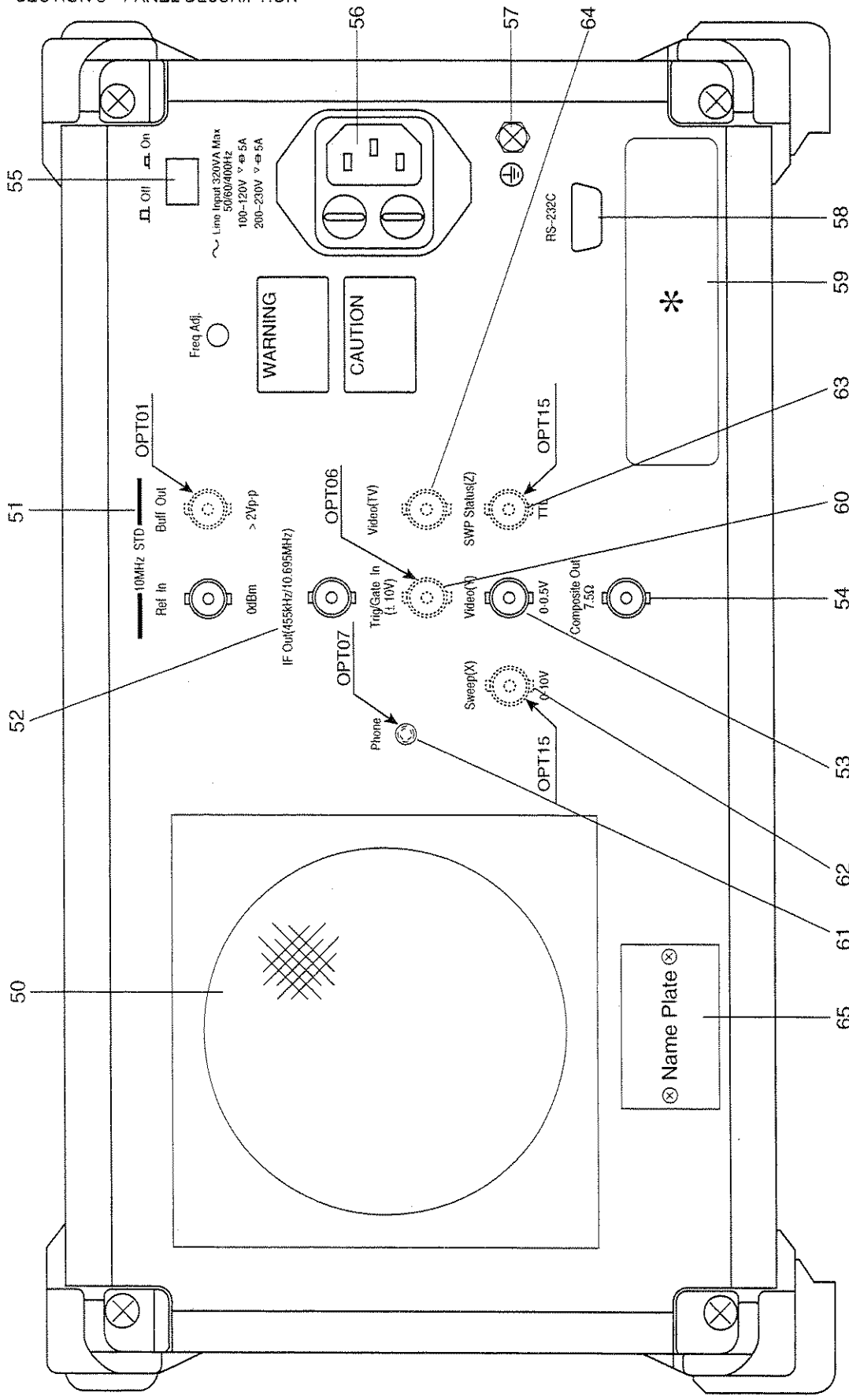

Fig. 3-1 Front Panel

SECTION 3 PANEL DESCRIPTION



⊗: For OPT10

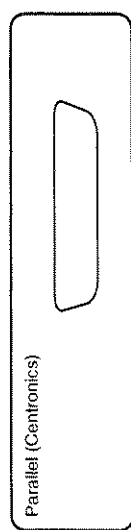

Fig. 3-2 Rear Panel

SECTION 4

SOFT-KEY MENU

In this section, soft-key menu functions and its hierarchical system are described using a tree.

TABLE OF CONTENTS

Soft-key Menu List	4-4
Menu Tree	4-6

SECTION 4

SOFT-KEY MENU

In this section, soft-key menu functions and its hierarchical system are described using a tree. Matters to be noted about the tree are shown below.

- (1) Panel Key indicates a hard key on the front panel.
- (2) Top menus are the menus at the top level which are displayed on the screen when the panel key is pressed. Lower menus indicates other menus below the top menus.
- (3) When a soft key with an appended asterisk (*) is pressed in these menus, the menu moves to the lower menu indicated by the arrow symbol (->). However, if any not-supported-function soft key in an Option is pressed, an error message is displayed.
- (4) When the Return key is pressed at a lower menu, the next-higher menu is returned.
- (5) Menus with more than six items are split into several pages.
- (6) The menu page construction and currently-displayed page are indicated in the lower part of the menu. To move to the next page, press the [More] key.
- (7) Panel keys and soft keys prefixed by a sharp symbol (#) at the left of the menu frame, give an outline explanation of the function.

Soft-key Menu List

Menu	Menu Tree (page/28)	Menu	Menu Tree (page/28)
A) A/B,A/BG	16	G) Gate	18
A/Time	17	Gate Setup	18
ACP Setup1	8	H) Hold Count	15
ACP Setup2	8	I) Impedance	2
ACP Setup3	8	Initialize	27
Adj ch Pwr	8	Interface	23
Amplitude	2	Item	12 , 20
Attenuator	2 , 3	L) LCD Brightness	21
Avg Count	15	Lib Exec	26
B) Burst Pwr	11	Lib File	26
C) C/N Meas	7	Lib Memory	26
Channel Power Measure	8	Lib Prgm	27
Cal	22	Lib Remove	26
Change Clr	21	Lin Scale	2
Check File	26	Line	9 , 10
Copy Cont	20	Load/Save	9 , 10
Copy from	21	Location	20
Correction	2	Log Scale	2
CountSetup	7	Lvl Offset	2
D) Def Files	27	M) Manual Set	4
Def Menus	27	Marker	4
Define	27	Marker->	4 , 5
Define Clr	21	Mask Meas	9
Detection	15 , 17	Measure	7
Dip	5	Media	25 , 27
Directory	25	Media	2 , 9 , 10
Disp Line	2 , 4	Mem Card	25
Display	21	Mkr List	4
E) Edit Menu	27	Move Mask	9
Expand	17	Move Temp	10
F) File Ope	25	Multi Marker	4
FM Monitor	17	N) Noise Meas	7
Format	25		
Freq Count	7		
Frequency	1		

Menu	Menu Tree (page/28)	Menu	Menu Tree (page/28)
Normalize	14	Sweep Time	3
O) OBW Setup	8	Swp Contl	16 , 17
Occ BW	8	System	21
P) Paper Size	20	T) Temp Meas	10
Peak	5	TG	14
Plotter	20	Threshold	5
Pon State	21	Title	24
Pre Ampl	2	Trace A,B	14 , 15
Preset	28	Trace Calc	15
Preslctr	22	Trace Move	15
Printer	20	Trace Time	17 , 18
PTA	25	TrackingAd	14
PTA Lib	26	Trnsformer	2
Q) QP/EMC	24	Trig Ext	18
R) RBW	3	Trig TV	18
Recal Media	12	Trig Video	18
Recall	12	Trigger	18
Ref Line	15	TV Monitor	19
Ref Step	2	U) Units	2
RS232C	24	User1	6
S) Save	13	User2	6
Save Media	13 , 20	User3	6
ScrollStep	1	V) VBW	3
Select	2 , 9 , 10	W) Wide IF	18
Set Date	21	Z) Zone Width	4
Set Time	21		
Setup	2		
Setup Mask	9		
Setup Temp	10		
Source	17 , 18		
Sound	21		
Span	1		
Storage	15 , 17		

Menu Tree

Menu Tree (1 /28)

Panel Key | Top menu | Lower menus

Frequency	Frequency
	Center Freq
	Start Freq
	Stop Freq
	Peak ->CF
#1	Auto Tune
#2	CF
	Step Size
	1

- Set items related to frequency, including the center frequency, start/stop frequency, peak->CF, auto synchronization, frequency scroll step size and scroll step size, etc.

#1 Detects peak point in pre-specified (in BG range) span and automatically tunes the peak signal to the specified span.

#2 Sets frequency step size for changing center frequency.

Frequency	Band *
	Scroll->
	<-Scroll
	* Scroll
	Step Size
	2

Band	Auto Band
	Manual Band 0
	Manual Band 1-
	Manual Band 1+
	return
	1

ScrollStep	1div
	2div
	5div
	10div
	return

Span	Span
	Span
	Full Span
	Zero Span
	Scroll->
	<-Scroll
	* Band

- Set frequency span items, including frequency span, full span, zero span, frequency span scroll, etc.

Menu Tree (2/28)

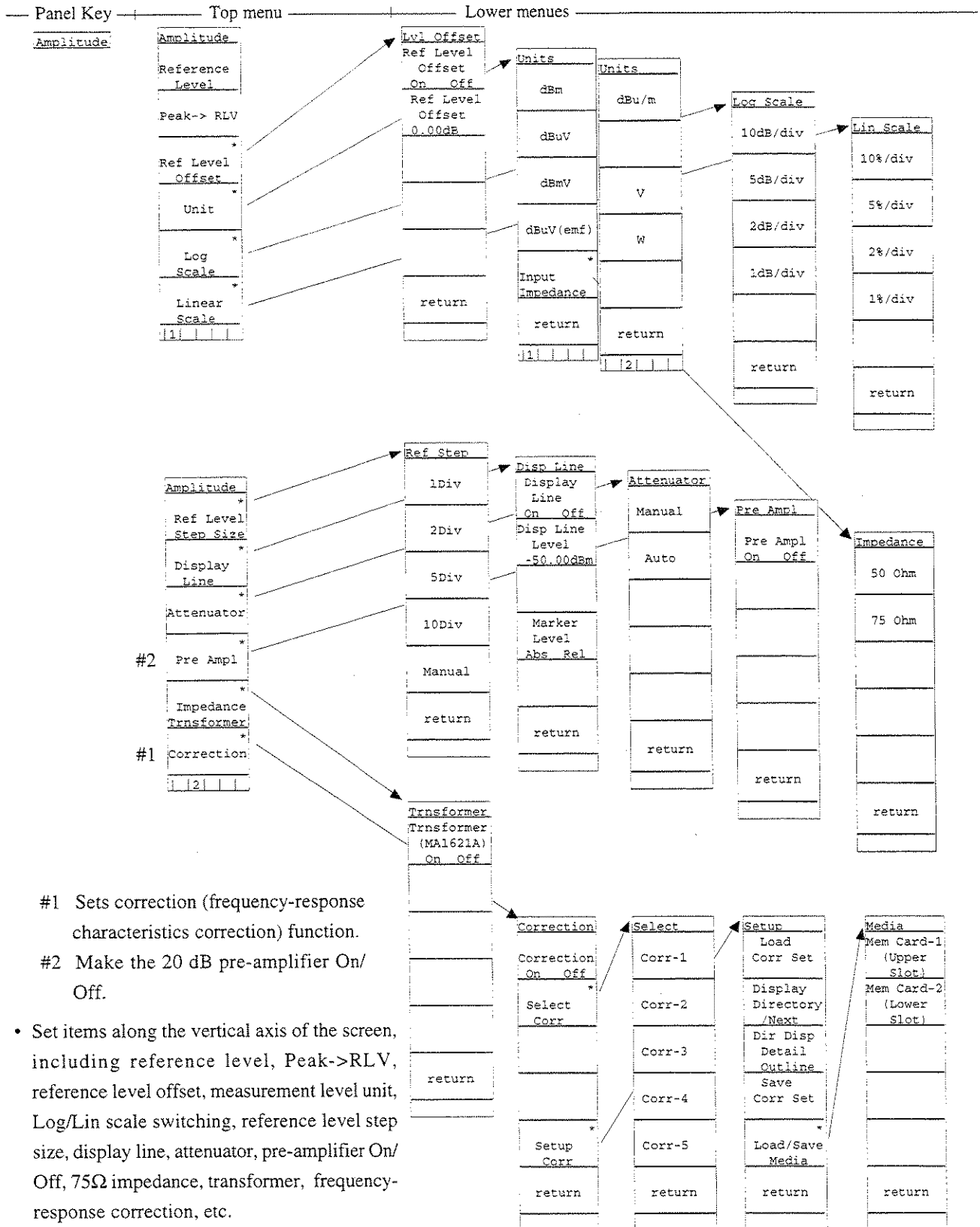

- #1 Sets correction (frequency-response characteristics correction) function.
- #2 Make the 20 dB pre-amplifier On/Off.

- Set items along the vertical axis of the screen, including reference level, Peak->RLV, reference level offset, measurement level unit, Log/Lin scale switching, reference level step size, display line, attenuator, pre-amplifier On/Off, 75Ω impedance, transformer, frequency-response correction, etc.

Menu Tree (3/28)

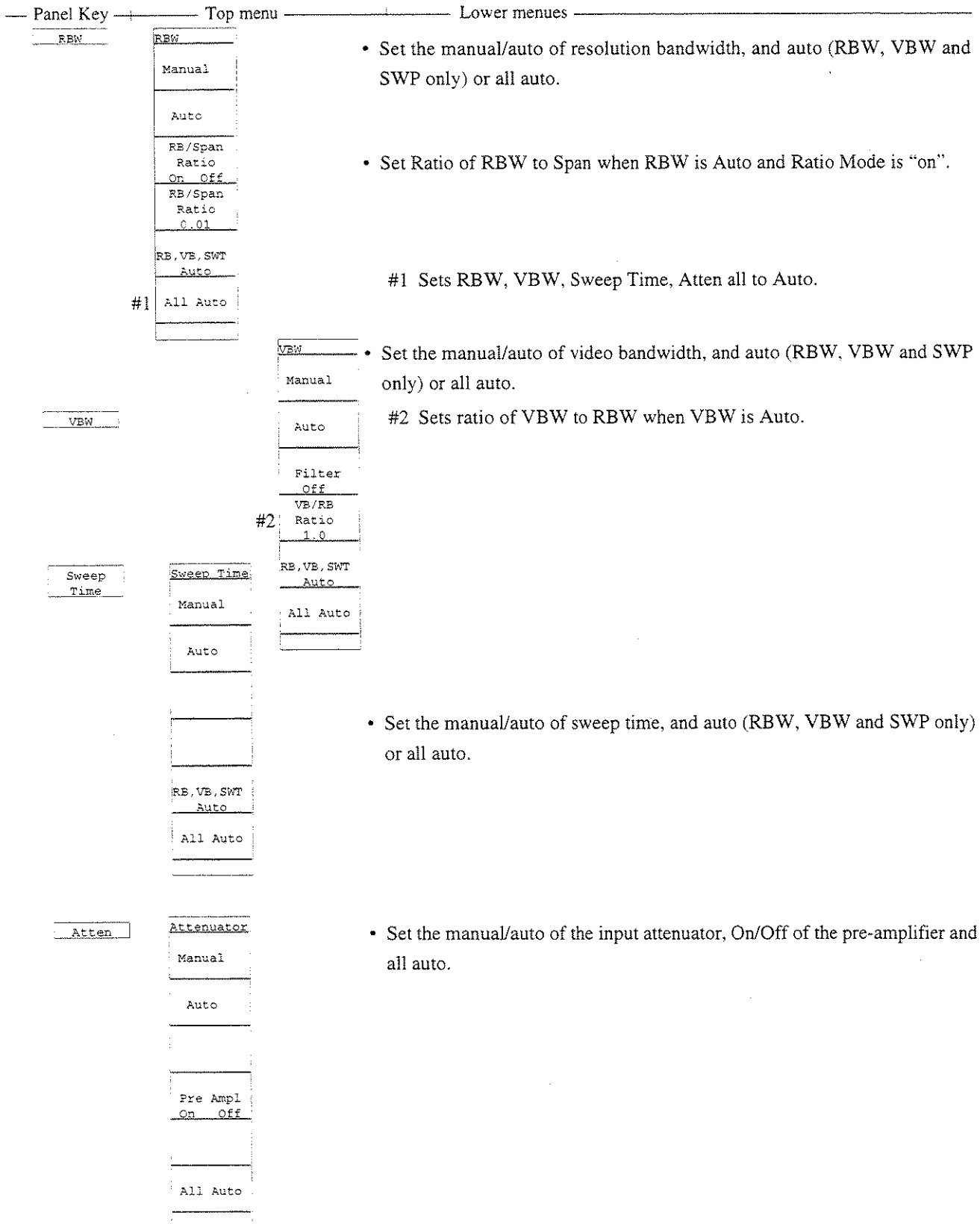

Menu Tree (4/28)

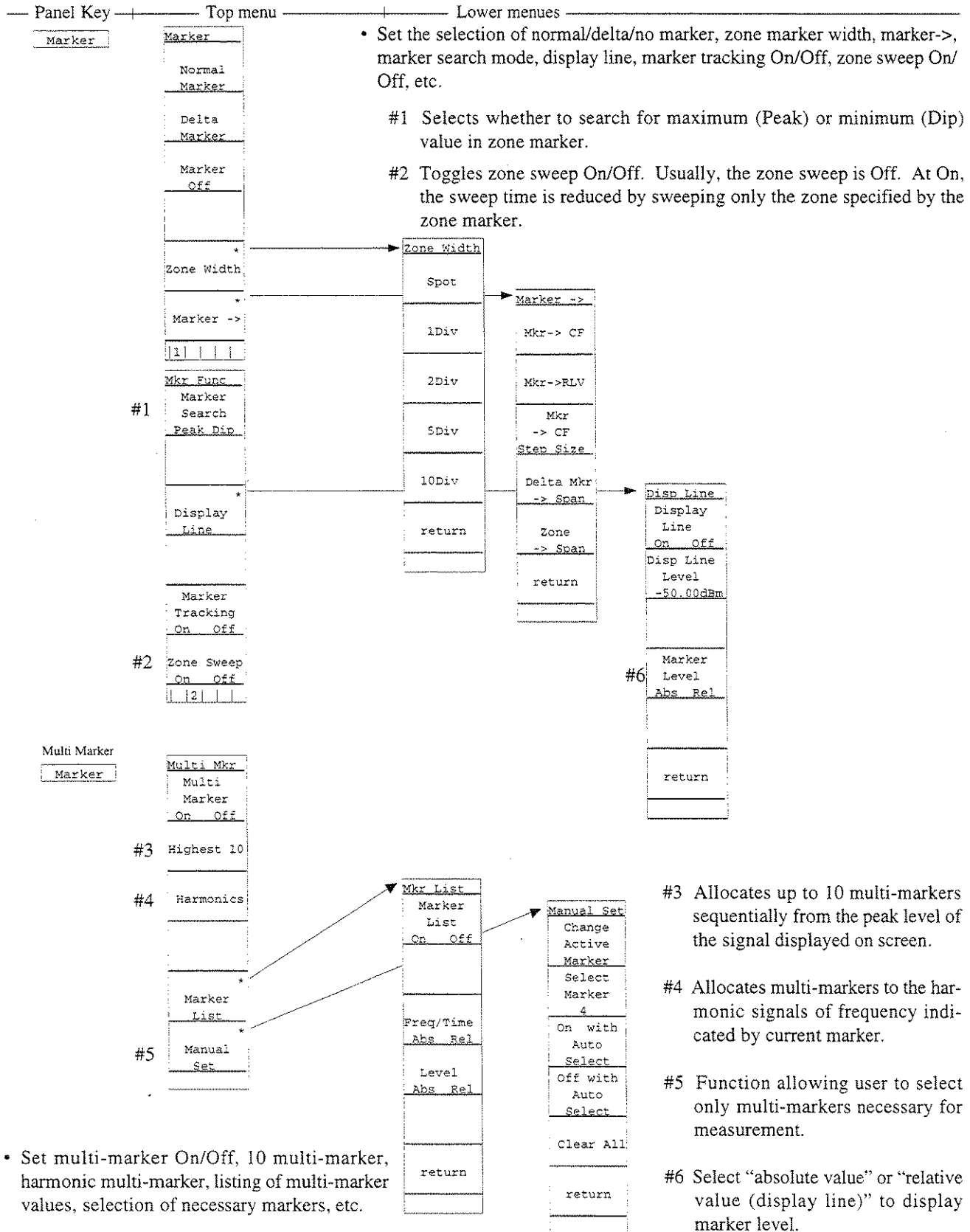

Menu Tree (5 /28)

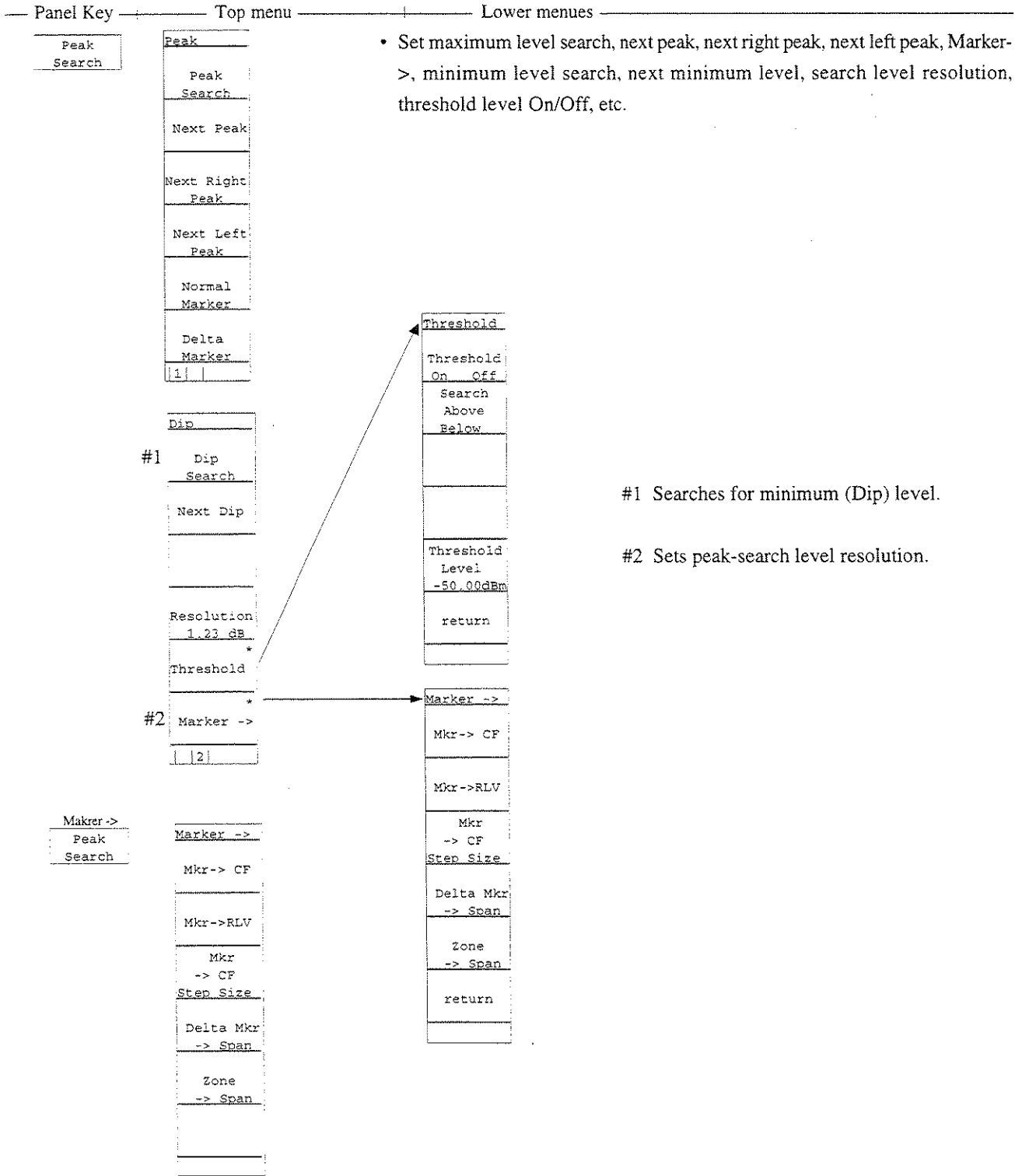

- Set maximum level search, next peak, next right peak, next left peak, Marker->, minimum level search, next minimum level, search level resolution, threshold level On/Off, etc.

- #1 Searches for minimum (Dip) level.
- #2 Sets peak-search level resolution.

- Set marker value -> center frequency, marker value -> reference level, marker value -> CF step size, delta marker-> span, zone marker -> span, etc.

Menu Tree (6/28)

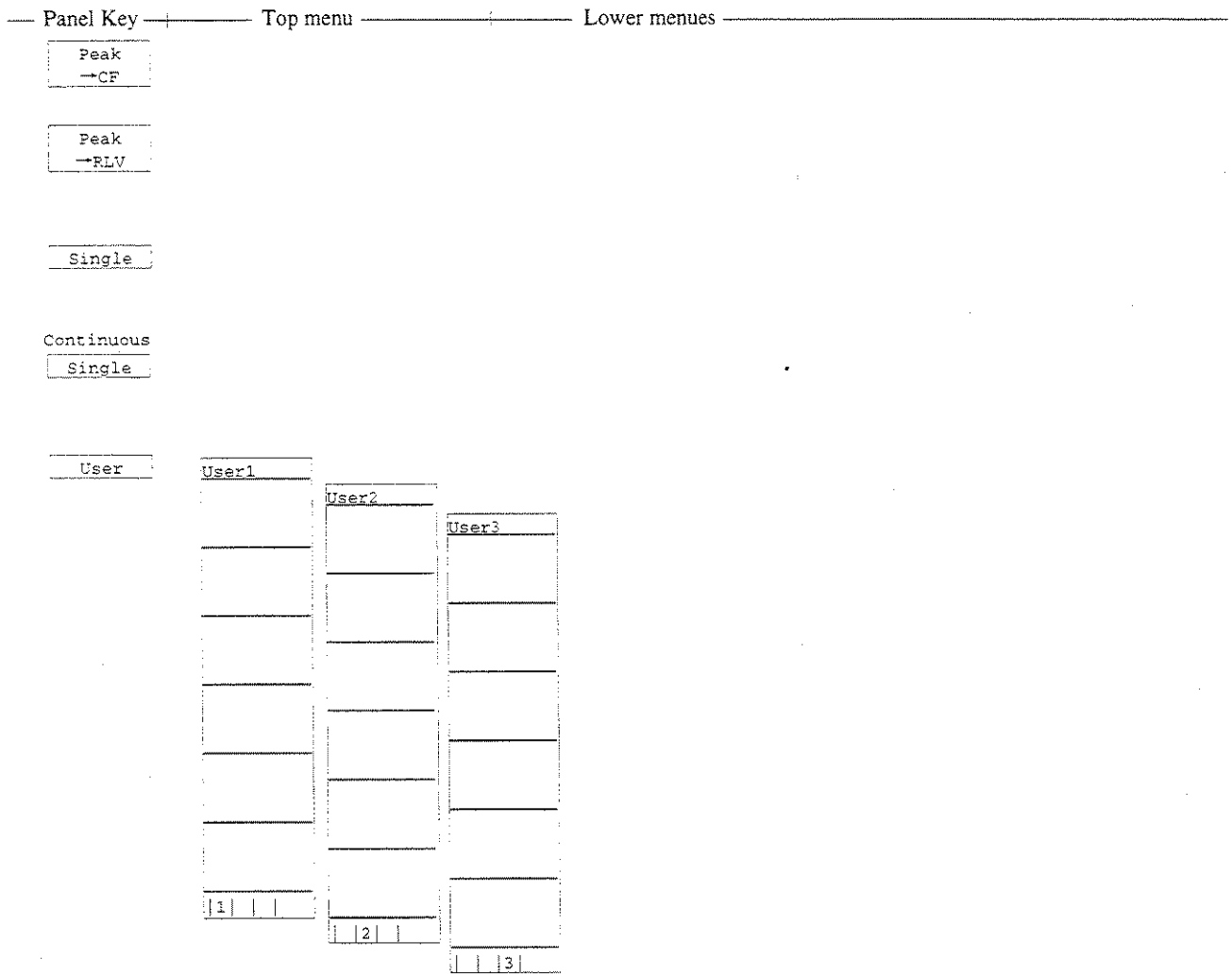

- The soft-key menu defined by the user is displayed. (See “User Define”.)

Menu Tree (7/28)

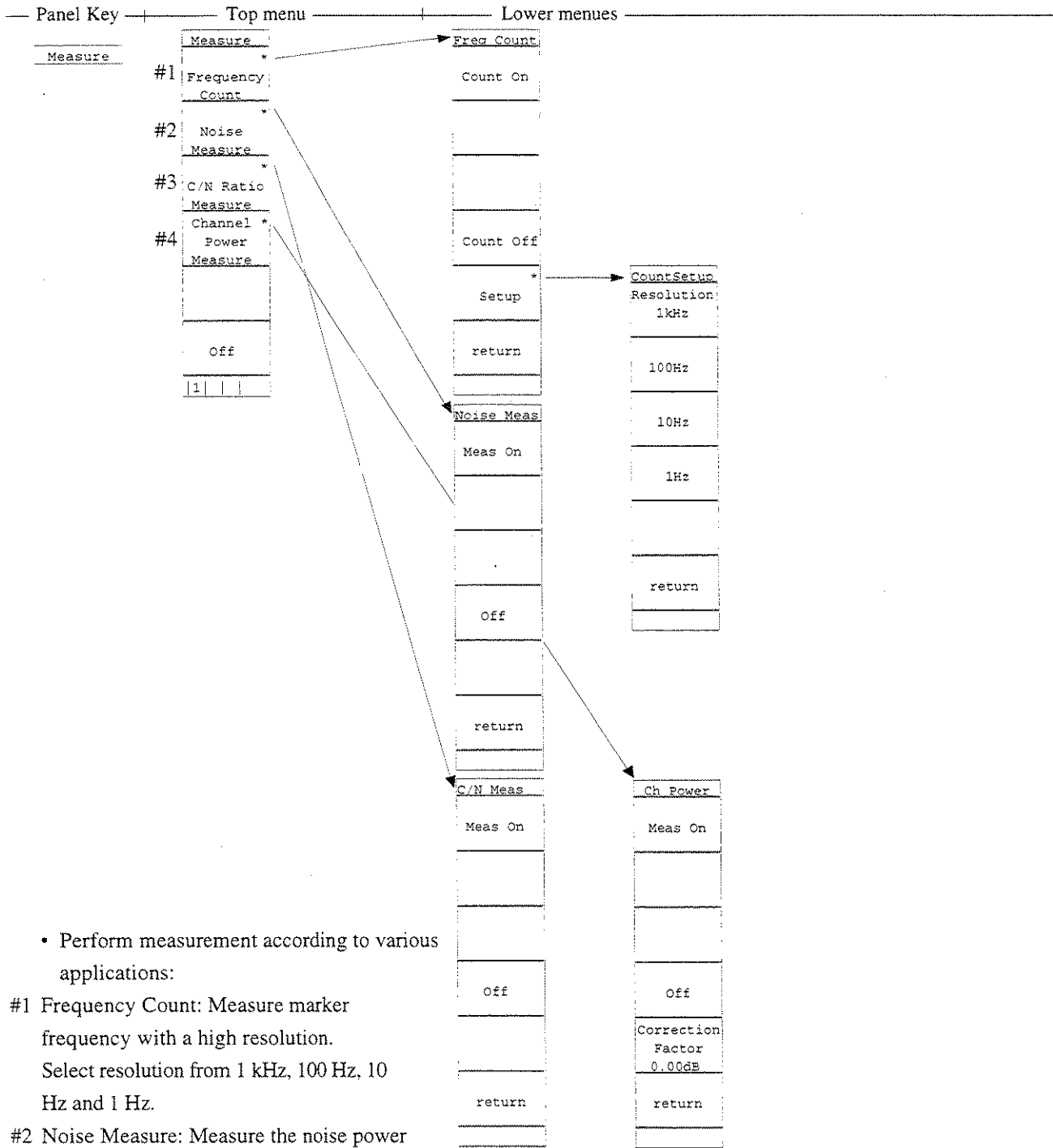

• Perform measurement according to various applications:

#1 Frequency Count: Measure marker frequency with a high resolution.

Select resolution from 1 kHz, 100 Hz, 10 Hz and 1 Hz.

#2 Noise Measure: Measure the noise power within zone marker.

#3 C/N Ratio Measure: Measure the ratio of carrier signal and noise power. Reference marker of the delta marker shall be set to the carrier, and marker's zone width specifies the power measured.

#4 Channel Power Measure: Power within the band indicated by zone marker is measured. It is possible to set an arbitrary calibration value.

Menu Tree (8/28)

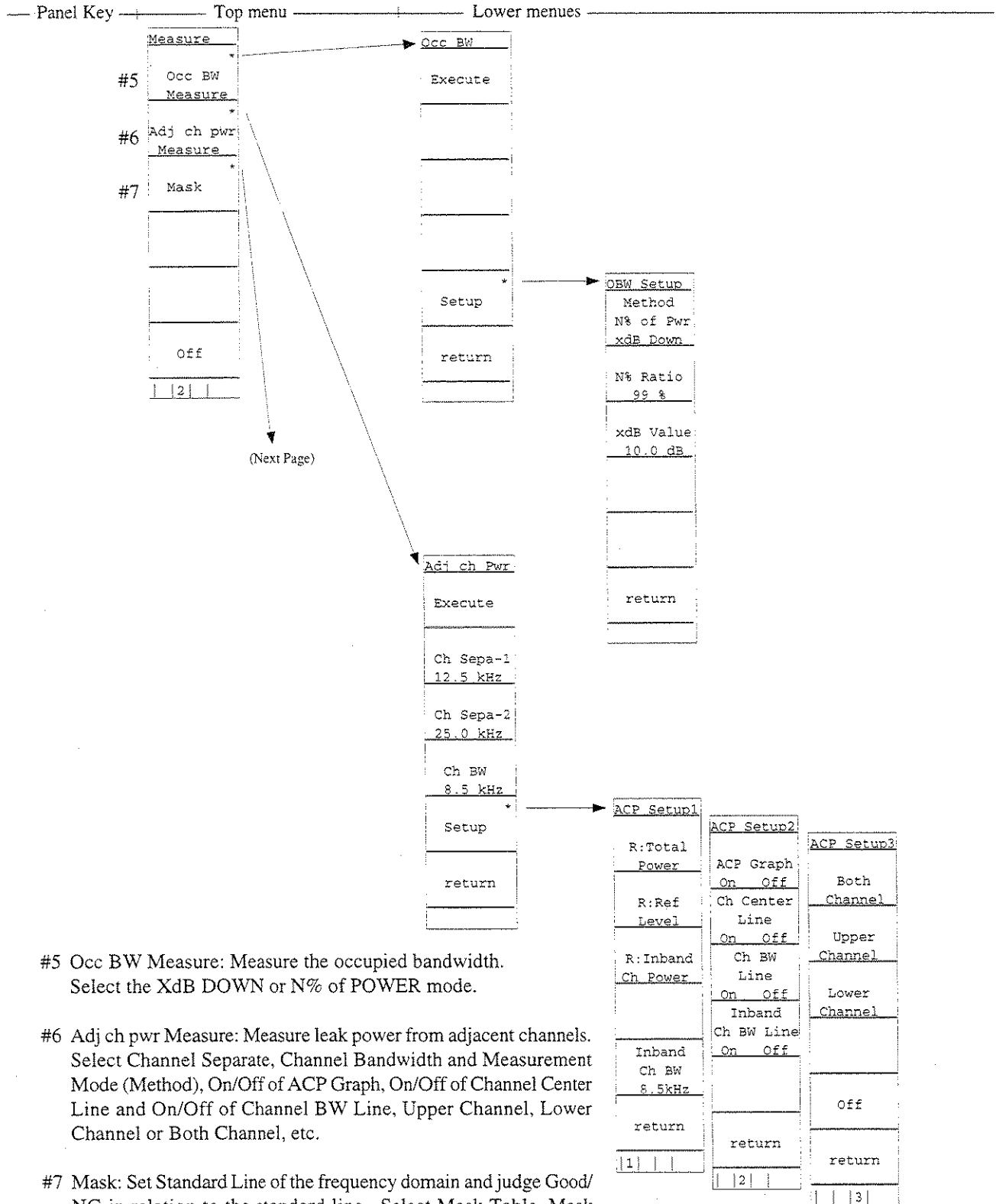

- #5 Occ BW Measure: Measure the occupied bandwidth. Select the XdB DOWN or N% of POWER mode.
- #6 Adj ch pwr Measure: Measure leak power from adjacent channels. Select Channel Separate, Channel Bandwidth and Measurement Mode (Method), On/Off of ACP Graph, On/Off of Channel Center Line and On/Off of Channel BW Line, Upper Channel, Lower Channel or Both Channel, etc.
- #7 Mask: Set Standard Line of the frequency domain and judge Good/NG in relation to the standard line. Select Mask Table, Mask Movement, Measurement Mode, Mask Table Preparation, Load/Save of Mask Table, etc.

Menu Tree (9/28)

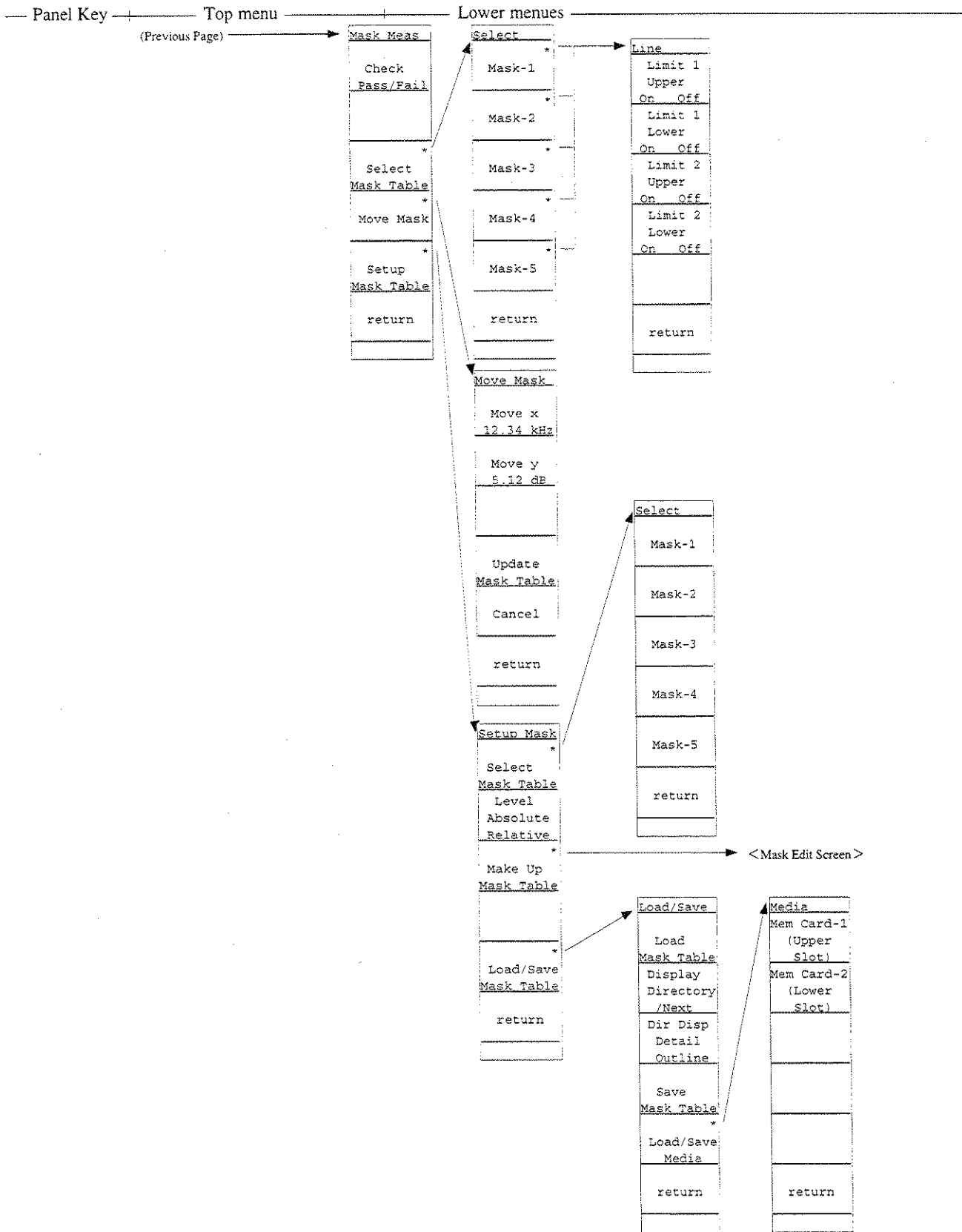

Menu Tree (10/28)

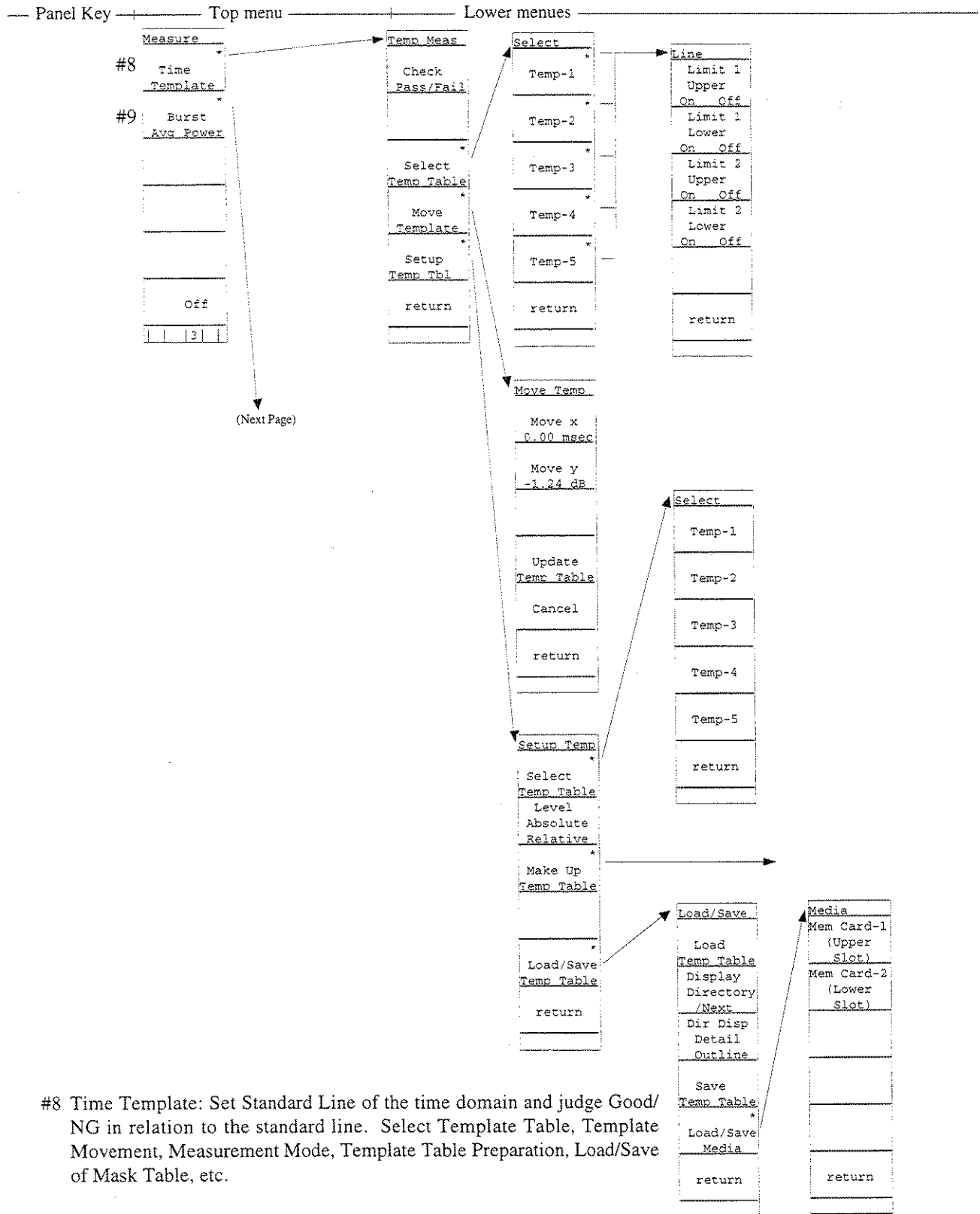

#8 Time Template: Set Standard Line of the time domain and judge Good/NG in relation to the standard line. Select Template Table, Template Movement, Measurement Mode, Template Table Preparation, Load/Save of Mask Table, etc.

#9 Burst Avg Power: Measure the mean power of burst signals in the time domain. Select the start/end points.

Menu Tree (11/28)

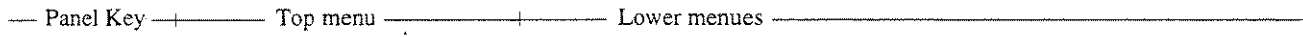

(Previous Page) →

BURST_Pwr
Execute
Start Point 100
Stop Point 100
return

Menu Tree (12/28)

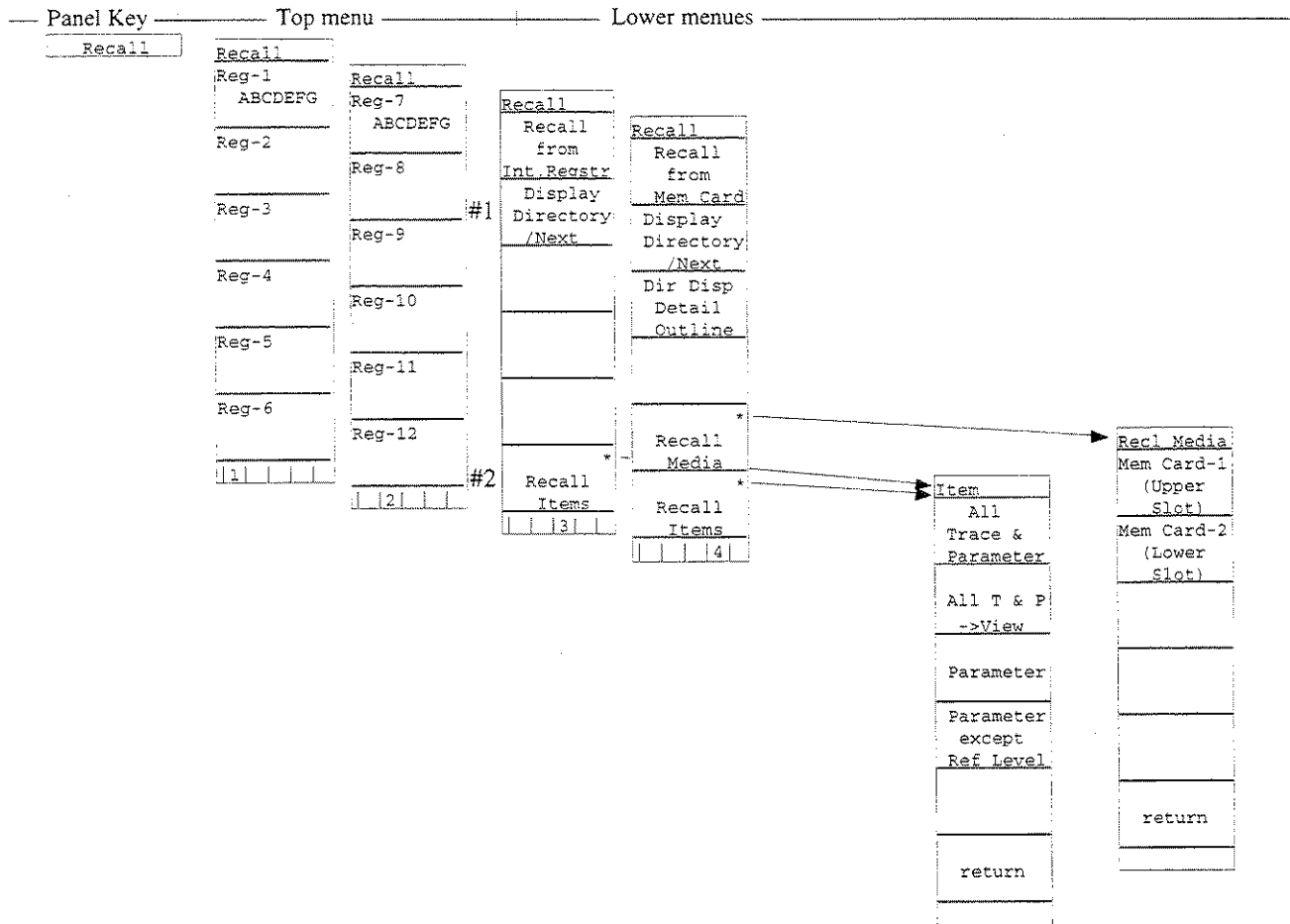

- Read out trace waveform/parameters from the internal memory or memory card. Select recall addresses and media/items, and display file directories.

#1 Displays list of internal-memory directories.

#2 Specifies items to be recalled
(trace waveform, parameter, etc.).

SECTION 4 SOFT-KEY MENU

Menu Tree (13/28)

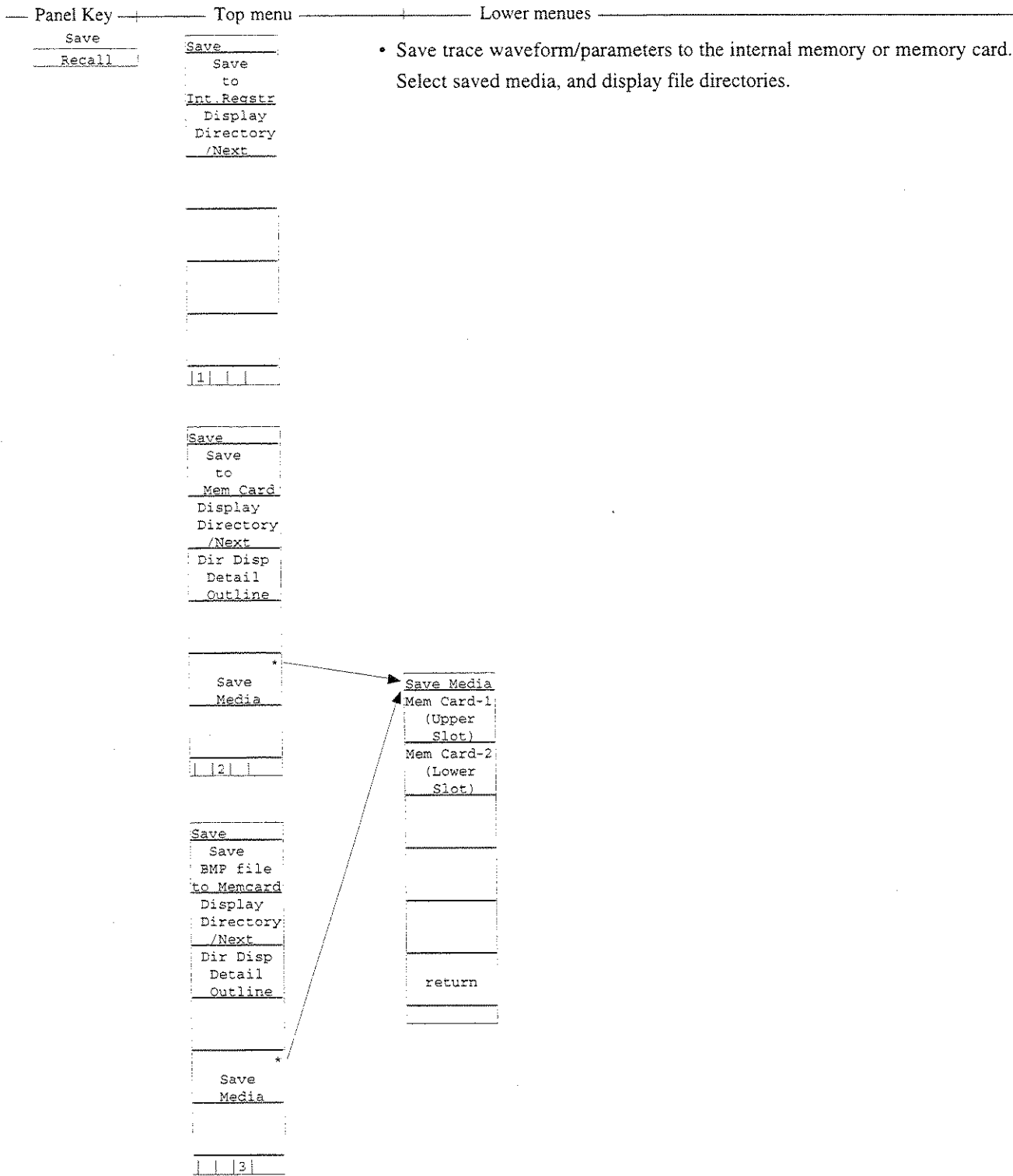

Menu Tree (14/28)

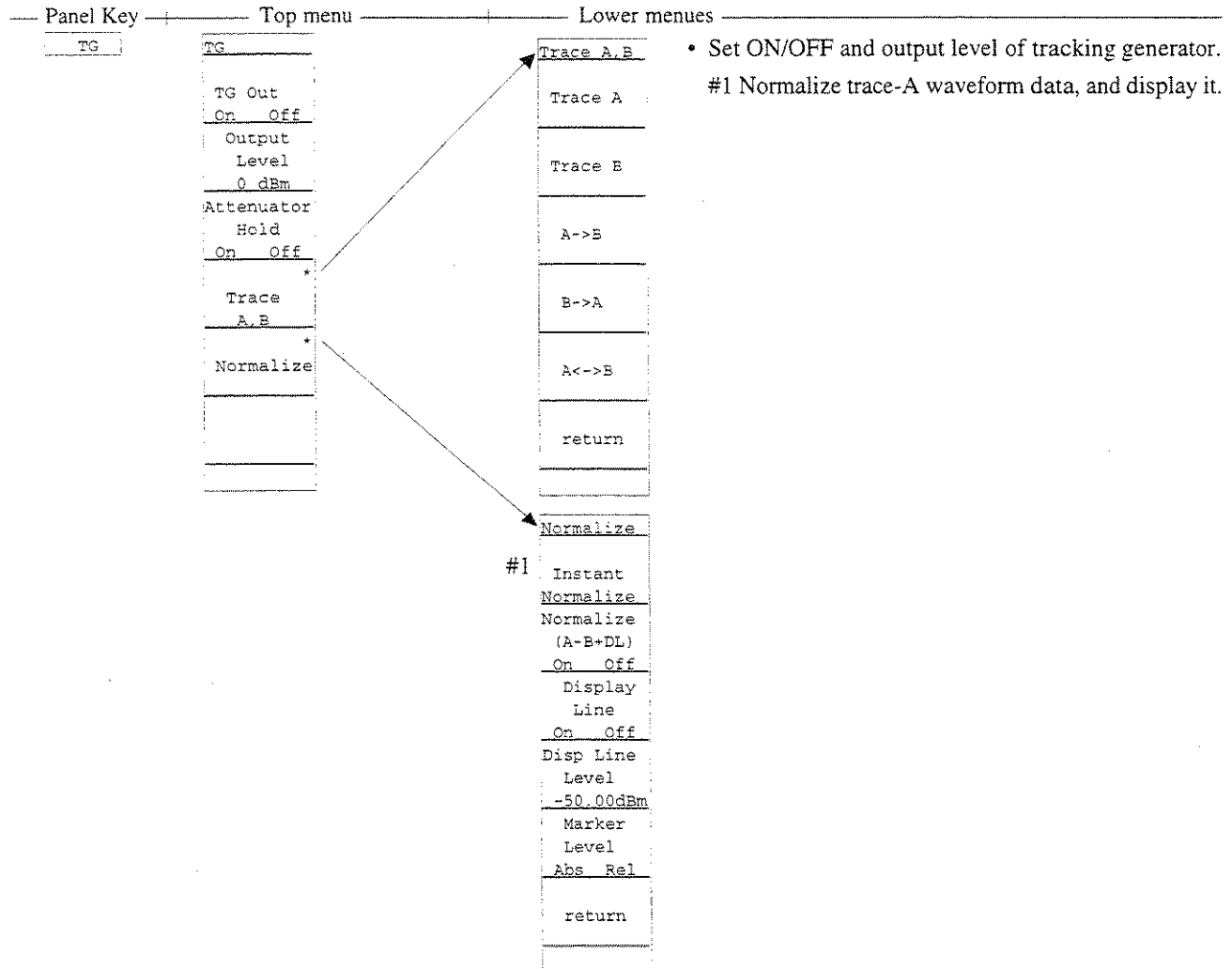

Menu Tree (15/28)

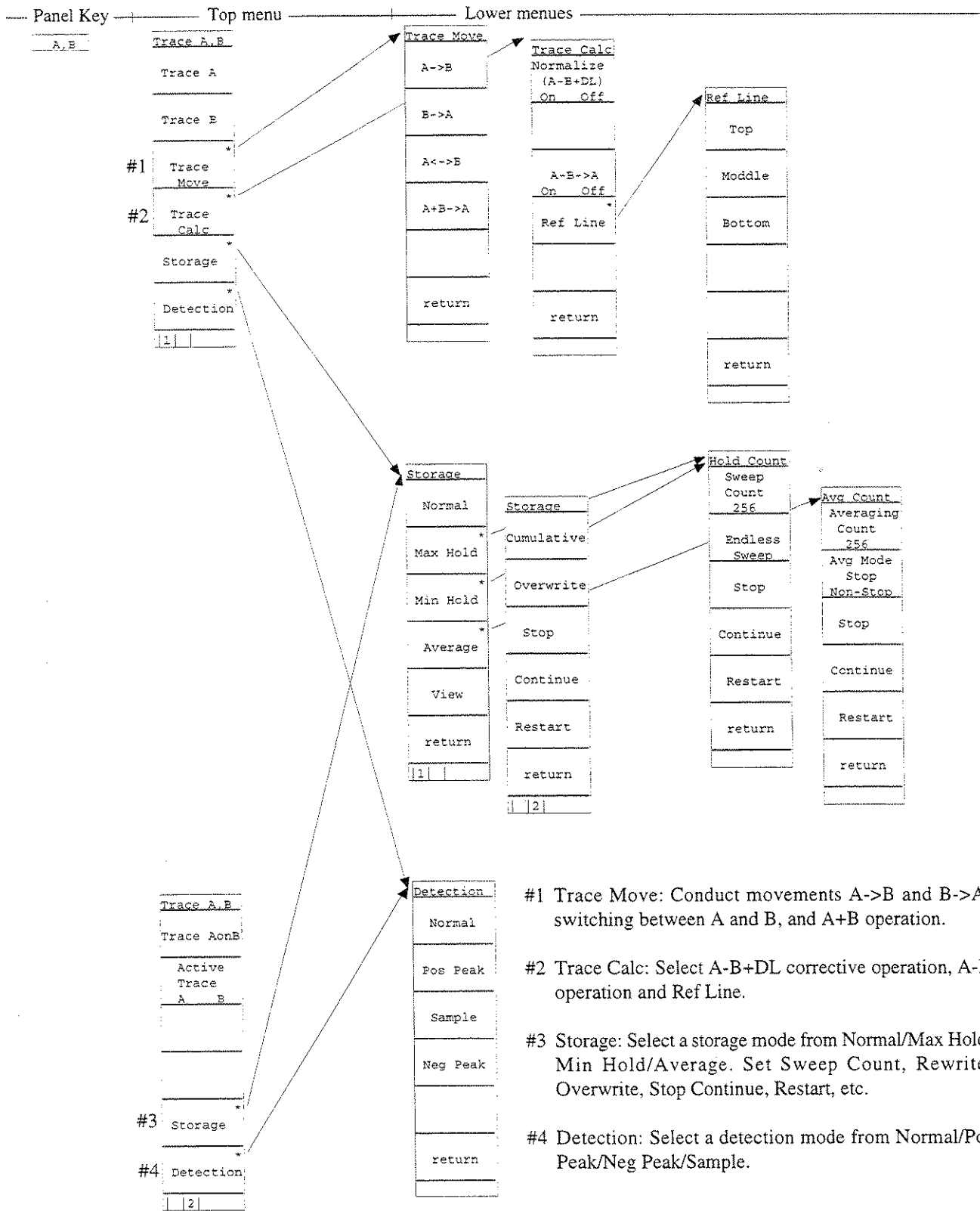

#1 Trace Move: Conduct movements A->B and B->A, switching between A and B, and A+B operation.

#2 Trace Calc: Select A-B+DL corrective operation, A-B operation and Ref Line.

#3 Storage: Select a storage mode from Normal/Max Hold/Min Hold/Average. Set Sweep Count, Rewrite/Overwrite, Stop Continue, Restart, etc.

#4 Detection: Select a detection mode from Normal/Pos Peak/Neg Peak/Sample.

- Select Trace A/B, movement between Trace A/B, sum/difference operation between Trace A/B and Ref Line, and designate the storage and detection modes and Active Trace.

Menu Tree (16/28)

— Panel Key — | — Top menu — | — Lower menus —

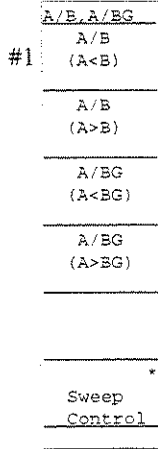

- Simultaneously display two waveforms, namely Trace A and Trace B or Trace A and Trace BG (peripheral spectrum containing Trace A). The large display is Main Trace and the small one is Sub Trace; select which to display as Main Trace (or Sub Trace).
Sweep Control: Set Stop/Continuous/Restart for sweep and Stop/Write for Sub Trace.

#1 Displays two traces A and B simultaneously at top and bottom of screen. The trace-B display is the larger at this time.

Menu Tree (17/28)

Panel Key | Top menu | Lower menus

Time
Trace Time
Delay Time
10.0 ms
Time Span
200 us
Trigger
Freerun
Triggered
+
Trigger
Source
+
Storage
+
Detection
1

- Set to the zero-span time domain display. Set Time Span, Trigger, Trigger Source, Storage, Detection and FM Monitor On/Off, and select Expand (waveform).

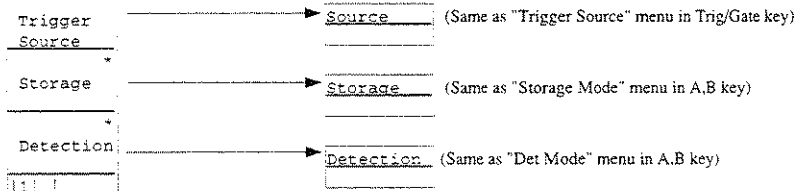

Trace Time
FM Monitor
+
Expand
+
+
+
+
2

FM Monitor
FM Monitor
On Off
Range
5kHz/Div
+
Expand
Zone Start
Point
100
Zone Span
Point
50
Expand
Zone
On Off
+
Expand
On Off
+
return

#1 Zooms in time-domain waveform display.

A/Time
Time
+
A/Time
A/Time
(A<Time)
+
A/Time
(A>Time)
+
+
+
+
+
Sweep
Control

Sweep Cntl
Sub Trace
Write
+
Sub Trace
View
+
Stop
+
Continue
+
Restart
+
return

#2 Displays trace-A waveforms in frequency domain and time domain simultaneously at top and bottom of screen. The time-domain display is the larger at this time.

- Simultaneously display waveforms of Trace a and Time Domain. Which to display as Main Trace (or Sub Trace) can be selected.

Menu Tree (18/28)

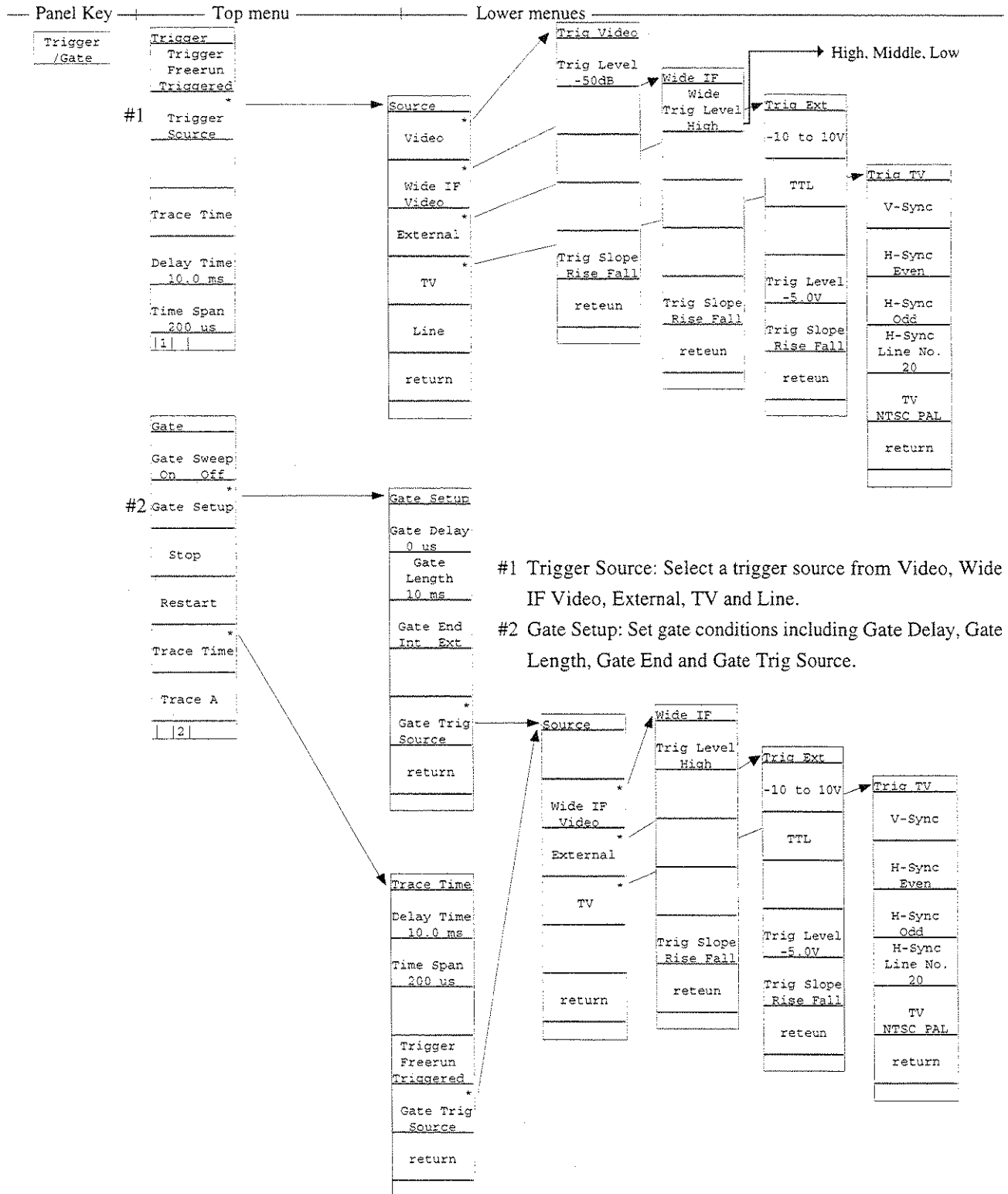

#1 Trigger Source: Select a trigger source from Video, Wide IF Video, External, TV and Line.
 #2 Gate Setup: Set gate conditions including Gate Delay, Gate Length, Gate End and Gate Trig Source.

- Set gate functions for controlling the sweep start trigger and the writing of waveform data. Set the trigger mode, trigger source, trace time, delay time and time span. Select On/Off, Stop and Restart of Gate Sweep.

Menu Tree (19/28)

Panel Key | Top menu | Lower menus

TV Monitor
Trig/Gate

TV Monitor
Change into TV Monitor
Current Channel 10
Adjust Level
Pre Ampl On Off
Sound Volume 10
Channel * Assign Japan TV
| 1 | |

TV Monitor
TV NTSC PAL
Sound * System 4.5MHz
Standard * System M-NTSC
Offset Freq 1.80000MHz
Setup * User Channel
| 2 |

Ch Assign
CCIR TV
US TV
Italy TV
Japan TV
User Define TV
return
| 1 | | |

Ch Assign
UK TV
China TV
return
| 2 | |

Ch Assign
CCIR CATV
US CATV
Japan CATV
User Define CATV
return
| 1 | | 3 |

Sound Sys
Sound 4.5MHz
Sound 5.5MHz
Sound 6.0MHz
Sound 6.5MHz
return

Setup
Load User Channel
Display Directory /NEXT
Dir Disp Detail
Outline
Save User Channel
Load/Save * Media
return

Standard
B/G/H PAL
M-NTSC
D-PAL
I-PAL
M-PAL
return

Media
Mem Card-1 (Upper Slot)
Mem Card-2 (Upper Slot)
return

- Display the received TV image on the monitor screen. Select On/Off of Pre Ampl, TV system and Channel Assign.

Menu Tree (20/28)

Panel Key | Top menu | Lower menus

Copy

Copy Cont
Copy

Copy Cont
Printer
Plotter
BMP file
To Memcard
Paper Feed
Stop Print
Plot
Location
Reset
| 1 |

Printer
HP2225
VP-600
(ESC/P)
Magnify
1x2
Printer
Address
18
return

Plotter
HP-GL
GP-GL
Paper
Size
Location
Item
Plotter
Address
18
return

Paper Size
A4
A3
Full
Size
Quarter
Size
return

Location
Auto
[] []
[] []
[]
[]
return

Copy Cont
Printer
Set up
Plotter
Set up
#1 BMP file
Save Media
[]
[]
[]
[]
| 2 |

- Set Printer/Plotter to hard-copy the screen. Set Printer/Plotter, Printer (model) /Plotter (model), Paper Feed, Stop Printer, Plot Location Reset, etc.

Save Media
Mem Card-1
(Upper
slot)
Mem Card-2
(Lower
slot)
return

Item
All
Trace
Scale
return

#1 Save the screen image data in memory card by BMP format (MS-DOS bit-map data format).

Menu Tree (21/28)

Panel Key | Top menu | Lower menus

Sound
Sound
AM
Narrow FM
Wide FM
TV
Off
Volume
6

- Demodulate the received signal and monitor-output it from the speaker. Select AM, Narrow FM, Wide FM, TV (voice) and Volume.

#1 Sets whether the coupled settings for RBW, VBW, etc., in frequency and time domain, independent or common.

#2 Changes screen color pattern.

System
Couple
Common
Independent
Display
Auto SWT
Hi-Lvl-Acc
Fast
Power On State
Erase
Warm up
Message

#1

Display
Parameter
Display
Type-1
Change Clr
Color Pattern1
Color Pattern2
Color Pattern3
Color Pattern4
Define User Color
return
Clock Disp
y/m/d
return

Define Clr
Copy Color
Patn from
Select Item
BackGround
Red
15
Green
15
Blue
15
return
Copy from
Color Pattern1
Color Pattern2
Color Pattern3
Color Pattern4
return

#2

System
Change Color
LCD
Brightness
Zero Span
Digital
Analog
FreqDomain
Lock
Unlock
Unlock
Count
20
Composite
Mode
3

Change Color
Color
Set Date
Year
Month
Day
Set Time
Hour
Minute
Second
Brightness
1
2
3
4
Off
return
Composite
Normal
PAL
NTSC
return

Set Date
Year
Month
Day
Set Time
Hour
Minute
Second
Brightness
1
2
3
4
Off
return
Composite
Normal
PAL
NTSC
return

- Set various modes of systems of this device. Set Couple, Display, Color Pattern, Define User Color, Time Sweep, Power On State, etc..

Menu Tree (22/28)

Panel Key | Top menu | Lower menus

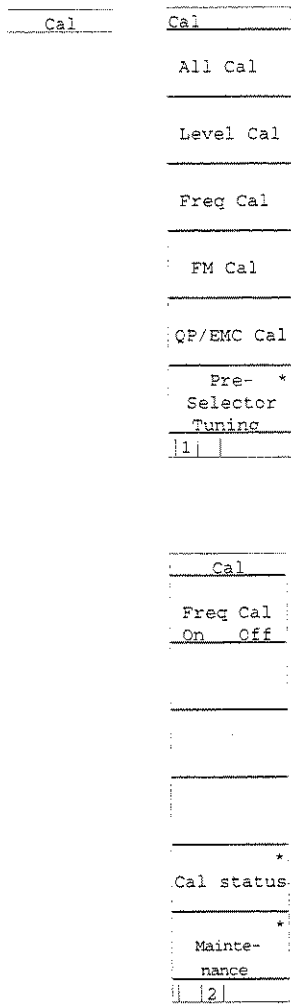

- Execute calibration. Select an item from All Cal, Level Cal, Freq Cal, and FM Demod Cal.



<Calibration status screen>

Menu Tree (23/28)

Panel Key | Top menu | Lower menus

- Set interfaces for external devices to connect. Select RS232C, Centronics or GPIB, and set the RS232C interface, GPIB address, etc.

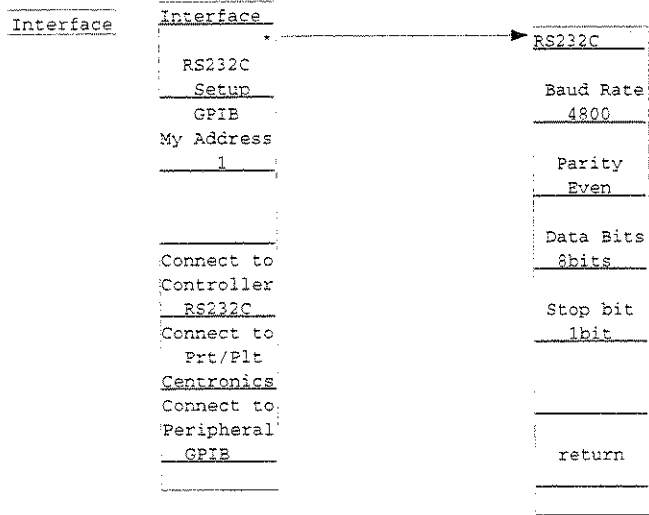

- Input a title to display on the screen.

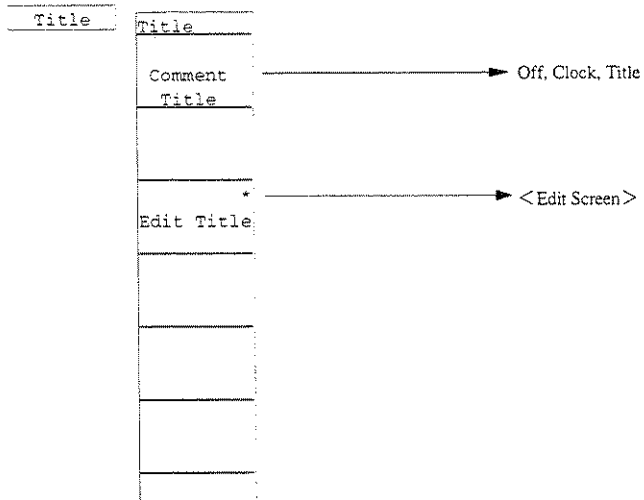

Menu Tree (24/28)

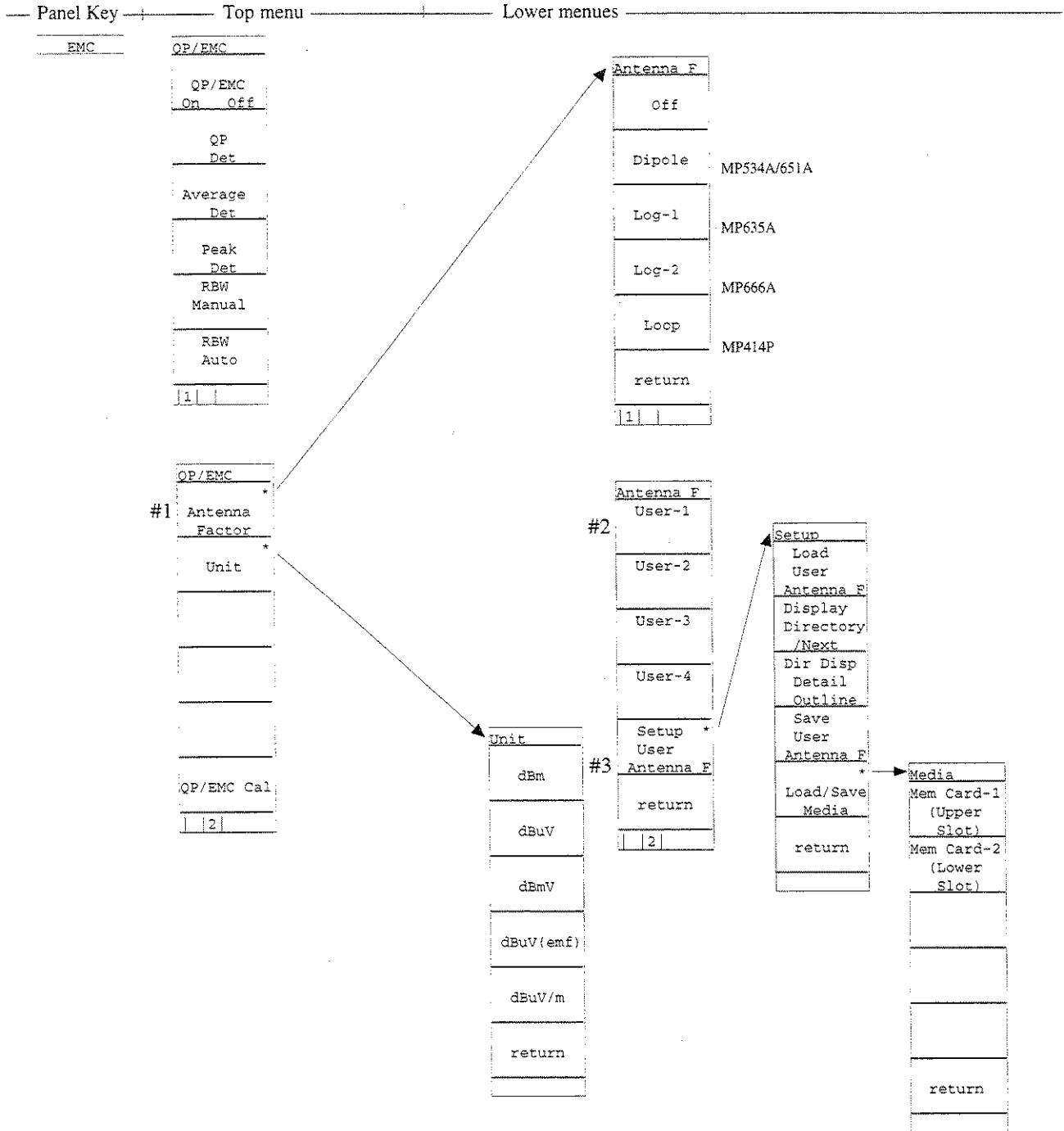

- Set the functions for QP detection/EMC measurement.
 - #1 Correction on the frequency characteristic of the antenna to be used is performed prior to measurements.
 - #2 When an user intends to use an own antenna, measurement is performed using its frequency characteristic correction data.
 - #3 Load/Save a user's antenna correction factor from/to memory card.

Menu Tree (25/28)

Panel Key | Top menu | Lower menus

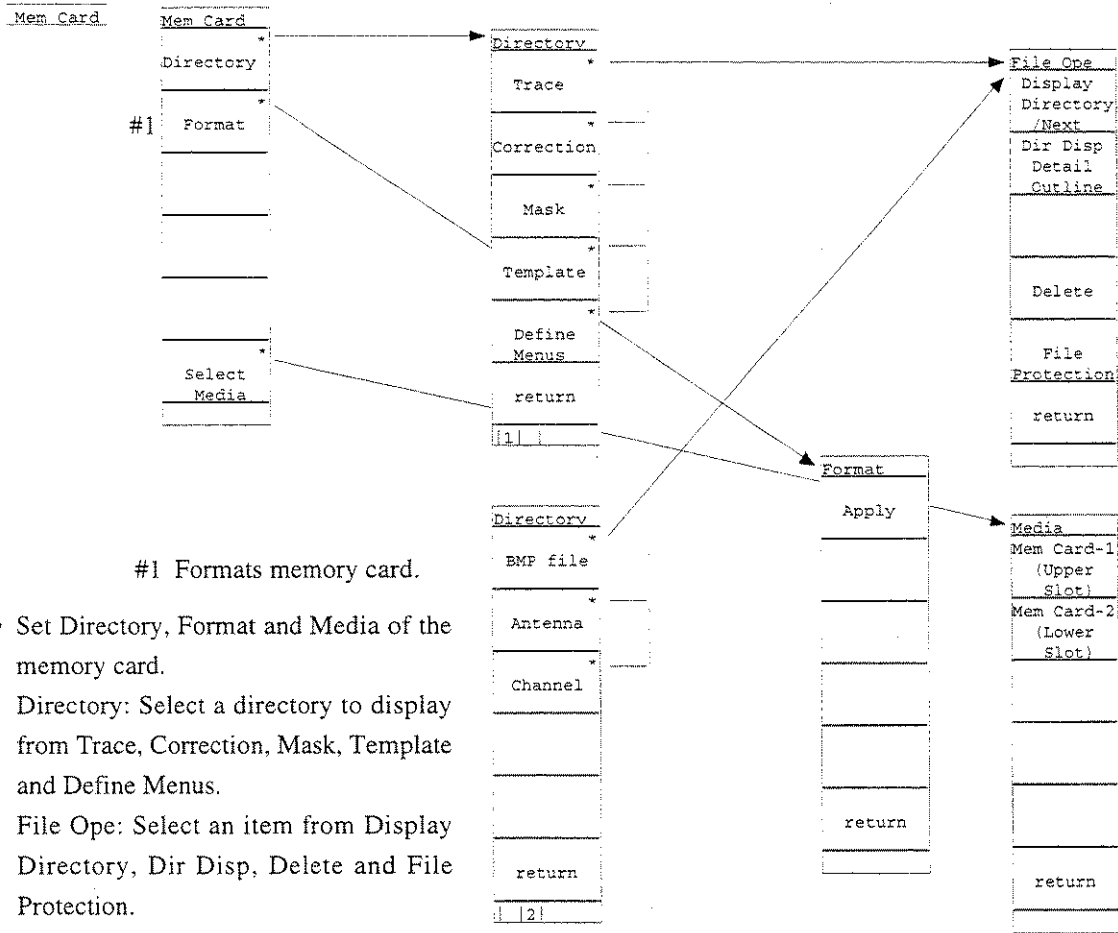

#1 Formats memory card.

- Set Directory, Format and Media of the memory card.
 Directory: Select a directory to display from Trace, Correction, Mask, Template and Define Menus.
 File Ope: Select an item from Display Directory, Dir Disp, Delete and File Protection.

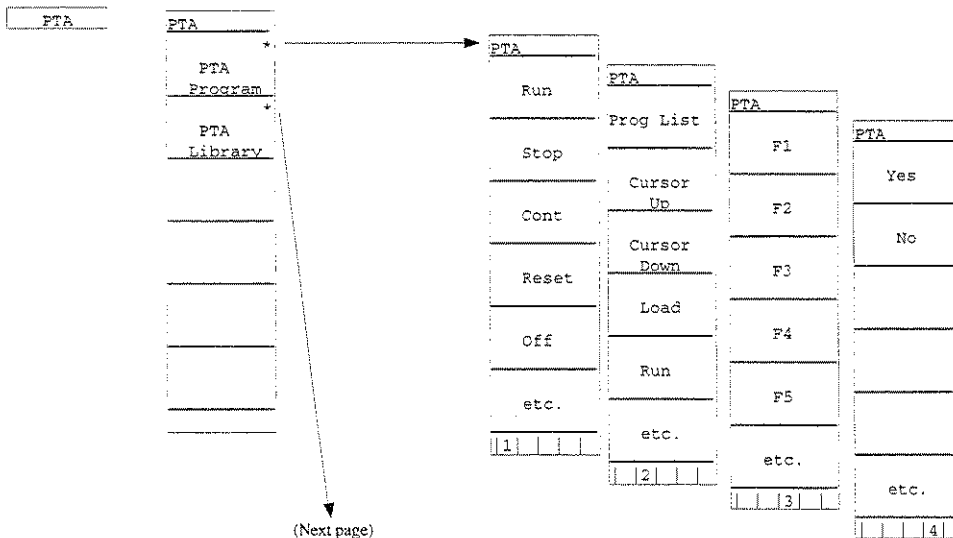

(Next page)

- Set PTA (personal test automation) that can build an auto measurement system without requiring external controllers.
 PTA Program: Select one from Run, Stop, Cont Reset, Prog List, Load, etc.
 PTA Library: Select one from Display/Run for the library program and Load/Check for the library file.

Menu Tree (26/28)

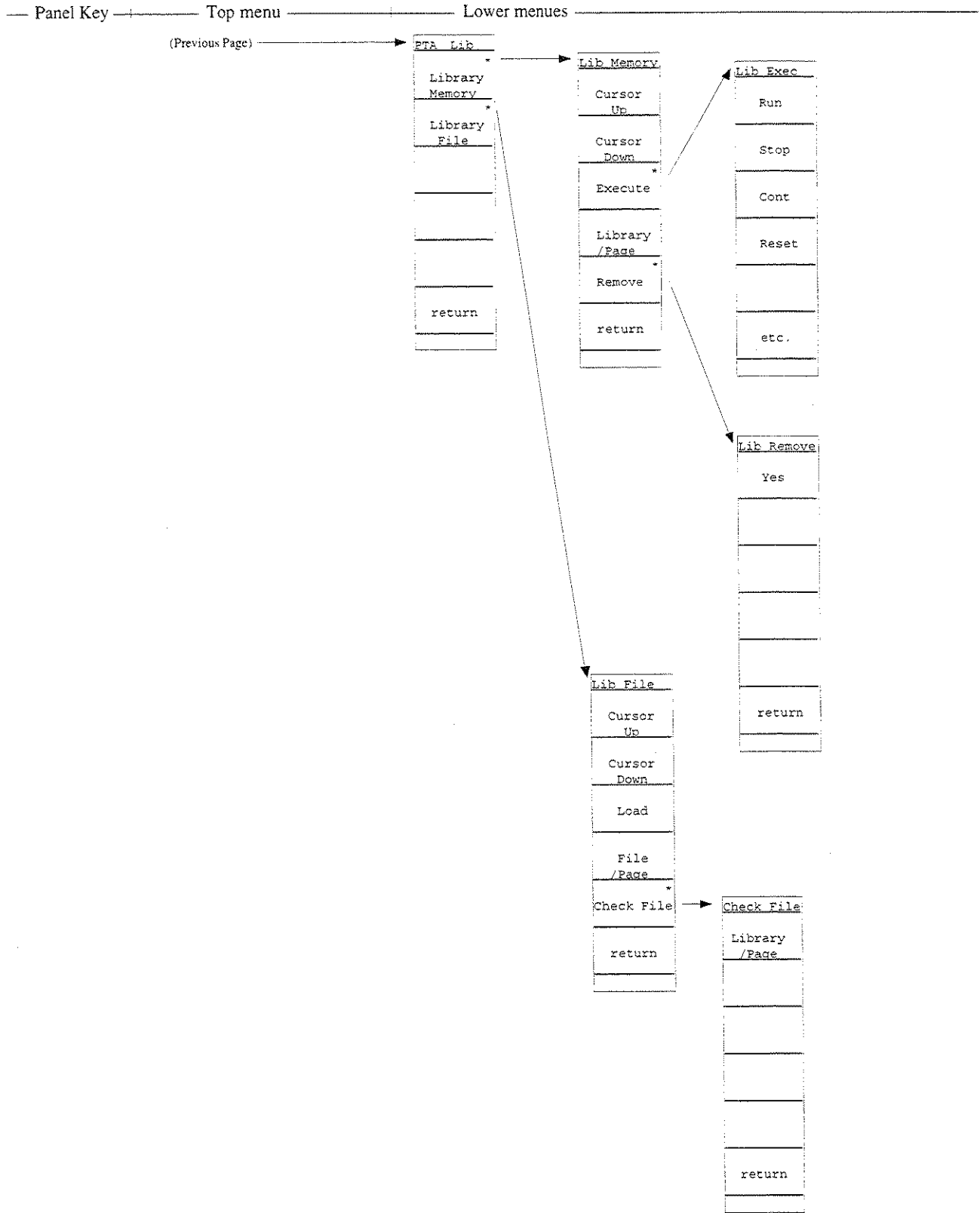

SECTION 4 SOFT-KEY MENU

Menu Tree (27/28)

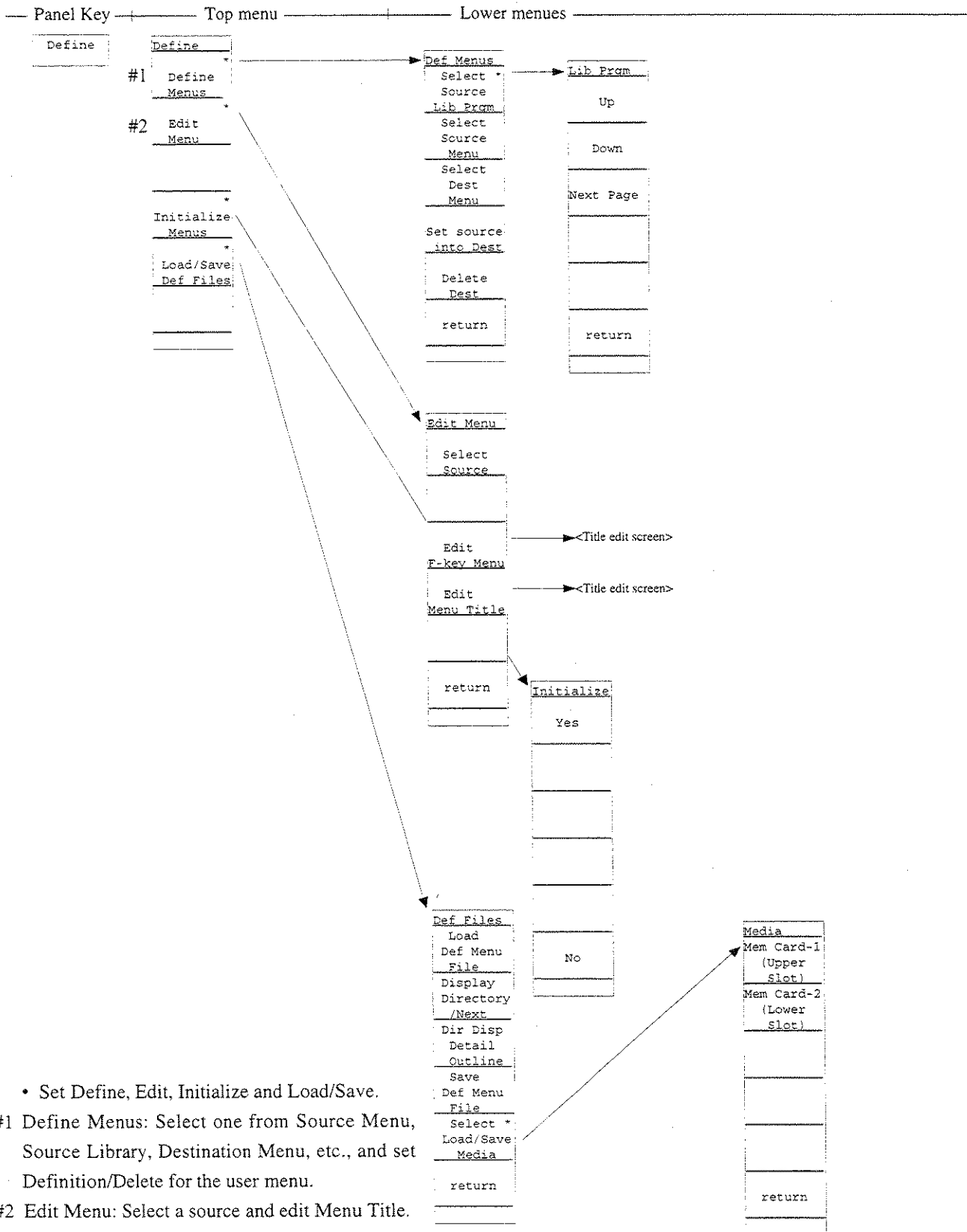

• Set Define, Edit, Initialize and Load/Save.

#1 Define Menus: Select one from Source Menu, Source Library, Destination Menu, etc., and set Definition/Delete for the user menu.

#2 Edit Menu: Select a source and edit Menu Title.

Menu Tree (28/28)

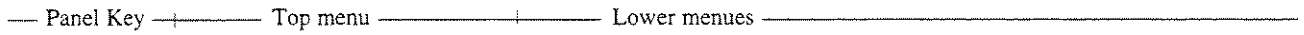

Preset	Preset
	Preset
	All
	Preset
	Sweep
	controll
	Preset
	Trace
	Parameters
	Preset
	Level
	Parameters
	Preset
	Freq/Time
	Parameters

- Initialize measurement parameters. Select one from All, Sweep, Trace, Level and Freq/Time.

Hold

Local

SECTION 5
BASIC OPERATION PROCEDURE

TABLE OF CONTENTS

Signal Display	5-3
Turn the power on	5-3
Execute automatic calibration	5-4
Set the signal to the center of the screen	5-4
Enlarge and display the signal	5-5
Marker Operation	5-6
Check of the zone marker function	
The "marker → CF" function check	
"Measure" Function Check	5-8
Screen Hard Copy	5-9

SECTION 5 BASIC OPERATION PROCEDURE

The basic operation procedure of this equipment are explained here. The operations are listed on the right. Also, the explanation will advance assuming that a 500 MHz signal is applied to the input connector. Please read this manual while operating this equipment.

(: Panel key, : Soft key)

<Actual operations>

- (I) Signal display
 - 1) Turn the power on,
 - 2) execute automatic calibration,
 - 3) set the signal to the center of the screen, and
 - 4) enlarge and display the signal.
- (II) Marker operation

Check of the zone marker function.
The “marker → CF” function check.
- (III) “Measure” function check
- (IV) Screen hard copy

Signal Display

Turn the power on

Press the standby button on the rear panel, then press the power switch (0) on the front panel. In this case, continue pressing the power switch for one second or more.

Press Preset key.

Press Preset All key in the menu.

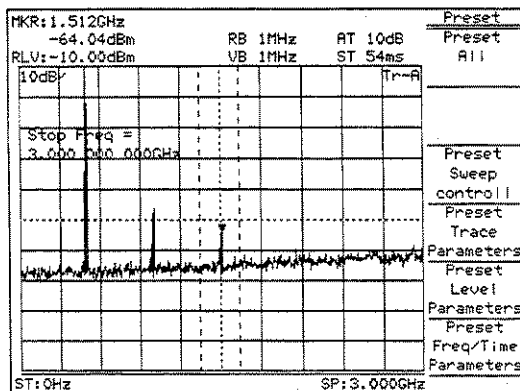

Fig. 5-1

The power is turned on/off only when the power switch is pressed for one second or more. This prevents the power from being turned on/off easily by mistake.

When panel key (hard key) is pressed, the related soft key menu is displayed.

Partial resettings are enabled. This resetting includes only the display-related resetting or the resetting of special modes such as zone sweep.

Execute automatic calibration

Wait after switching on the power supply of the machine (warm up period) till the internal temperature becomes stable. This period is approximately 10 minutes.

After warm up, execute automatic calibration.

Press **Shift** key then **CAL** key then **0** key.

Select **All Cal** from the menu displayed on the display.

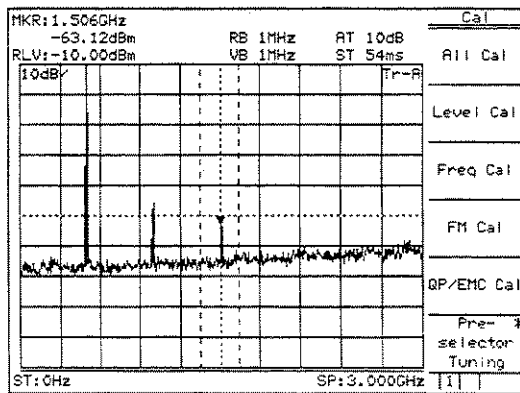

Fig. 5-2

Automatic Calibration is carried out by using an internal source without need for any external cable connection. See "Detailed Operation Instructions" for detail information about contents of calibration.

Set the signal to the center of the screen

Press **Frequency** key.

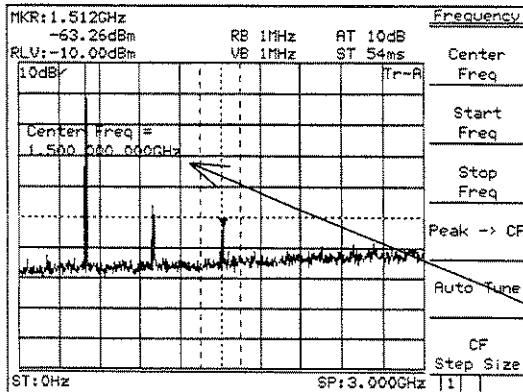

Fig. 5-3

When pressing Frequency, Span, Amplitude or Coupled Function key (s) which is used frequently, Center Frequency, Span, Reference Level, RBW or VBW function is selected and numeric value for the function can be entered into Entry area. This reduce key operation times.

This display section is called Entry area. Selecting the menu displays the current set value of the parameter. The set value can be changed by entering data in Entry area.

Press **Menu On/Off** key

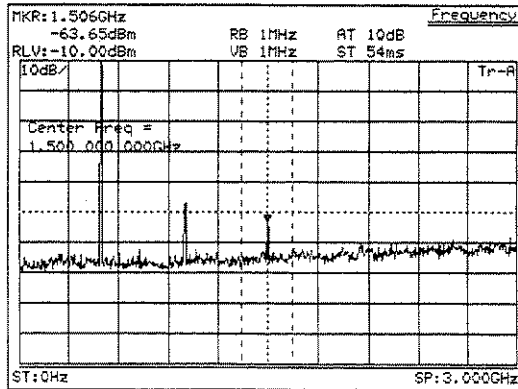

Fig. 5-4

The display of the soft key menu can be switched on/off using **Menu On/Off** key. When the menu disappears, the scale is enlarged. Also, when the menu is displayed, the scale is reduced.

Press **Menu On/Off** key to return to previous screen.

Use the ten-key pad (numeric keys) to enter 500 MHz.

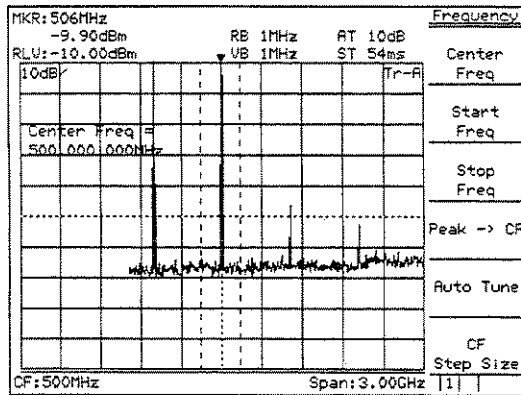

Fig. 5-5

The following three methods to input numeric values to parameters are provided: direct input by the ten-key pad (numeric keys), up/down keys, and rotary knob.

Enlarge and display the signal

Press **Span** key , then press the **V** down key several times to enlarge the signal display.

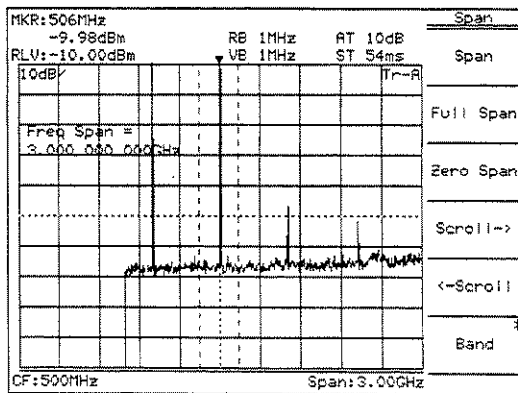

Fig. 5-6

Marker Operation

Here, checks that the signal frequency and level are displayed in a marker display area. The zone marker automatically fetches the highest level signal within the zone and displays the frequency and level.

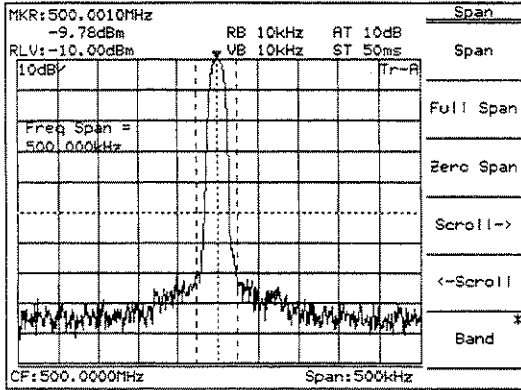

Fig. 5-7

To check Marker → CF function, shift the signal from the center intentionally.

Press **Frequency** key and **More** key in order, and then **Scroll →** key two times.

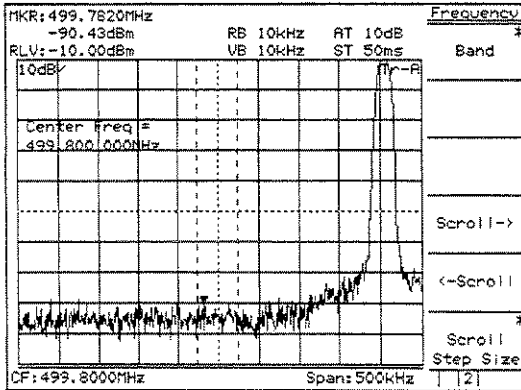

Fig. 5-8

The soft key menu marked by an asterisk on the upper right indicates that the menu can further be opened by pressing the key. Adversely, the soft key menu not marked indicates that the menu cannot be opened any more, so to speak, the end of menu opening.

The following items can easily be checked by the soft key menu tab: How many pages of the soft key menu being displayed currently are there?, and what page is displayed now?

To turn over the page, press **More** key.

Press **Peak Search** key.

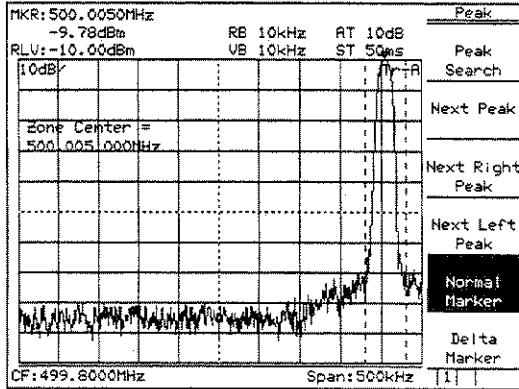

Fig. 5-9

*Advanced operation memo: It is convenient that the page can also be turned over by repeatedly pressing the panel key. This method is used when key (s), such as **Measure** key, has a number of pages. Besides, the Freq/Ampl and Marker-related keys do not turn over the page by repeatedly pressing the panel key. For these keys, because the first page is important specially, it should always be displayed when the panel key is pressed.

The marker fetches the signal.

Press **More** to open 2nd page, and press **Marker** → key.

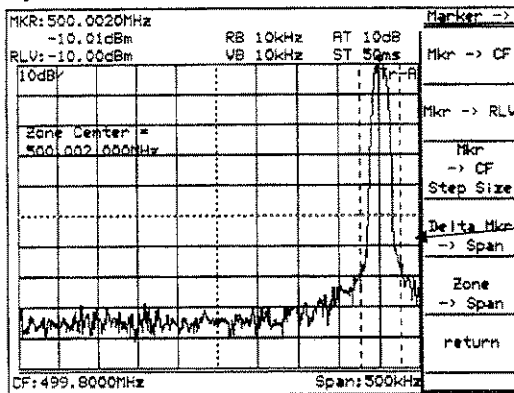

Fig. 5-10

When the soft key menu is pressed, a menu of function related to the menu is further displayed. In this case, as shown in the figure on the left, the thick line (the line on the preceding page) is displayed at the left of the soft key menu. This indicates that a new menu is overlapped with the preceding page.

Press **marker** → CF key.

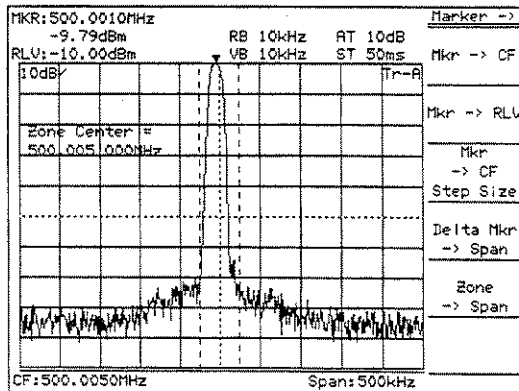

Fig. 5-11

The page opened by pressing the soft key can return to the preceding page by the **Return** key. Besides, it can be checked that which soft key menu was pressed previously to open the current menu, as the menu title is displayed on the upper row of the soft key.

Here, return to the screen of Fig. 5-8 and ensure that the screen changes to that of Fig. 5-11 only by pressing the **→ CF** key.

“Measure” Function Check

Press **Preset** key and **Preset All** key in order.

Press **Peak Search** key.

If the zero beat signal level (local feed through) is larger than the signal level and the marker fetches the zero beat level, press “Next peak” key and put the marker on the signal.

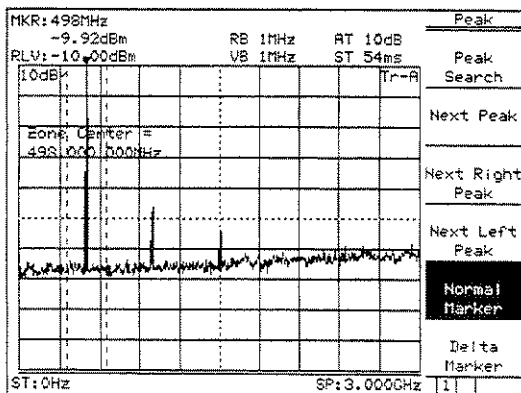

Fig. 5-12

Press the **Measure** key and **Frequency Count** key to set the function of high accuracy frequency measurement of the marker points.

Then, press the **Count On** key and start measurement.

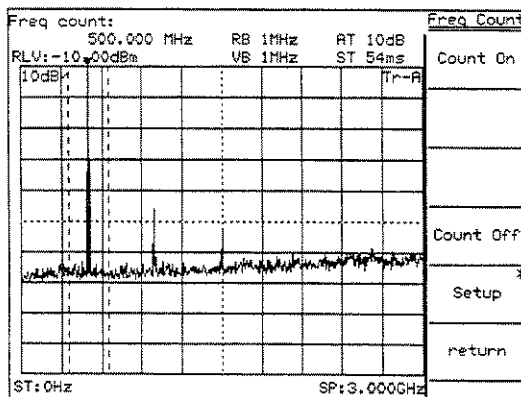

Fig. 5-13

The soft-key menu display can be switched On/Off by the **Menu On/Off** key.

However, keys that condition setting is not possible unless a menu is On unconditionally make the soft-key menu display On when pressing a panel key.

From the screen after executing measurement, press another panel key and change parameters, and then, pressing again the **Measure** key will automatically return to the menu of this screen and not to page 1 of the menu (page learning function).

It is a useful function when repeating measurement.

The frequency of marker point is displayed at the top left of the screen.

Incidentally, the internal counter correctly operates even at the full span condition, so an operation to reduce frequency span otherwise required is not necessary in this model.

Screen Hard Copy

The screen can be hard-copied with the VP-600 printer (Epson) via an RS232C interface, and the procedures are described below:

- 1) As illustrated below, connect the RS-232C connector and printer with an attached RS-232C cable.
- 2) Press the **Copy** key, and the currently displayed screen is hard-copied.
If the printed copy is improper, check if the RS-232C interface is correctly set in the following sequence.
- 3) Press the **Shift** key and then the **Interface** key.
- 4) Press the **Connect to Controller** key several times to get None on the display, and press the **Connect to Prt/Plt** key several times and get RS-232C on the display.
Now the printer can be operated with RS-232C.
- 5) Press the **RS232C Setup** key and set so that (or check if) the setting of RS-232C interface is the same between the main body and printer.
(For the setting/checking of the RS-232C interface on the printer side, refer to the instruction manual of the printer.)
- 6) Press the **Shift** key and then the **Copy Cont** key.
- 7) Press the **Printer/Plotter** key and select Printer.
- 8) Press the **Printer Setup** key, and then press the **VP-600** key.
- 9) Press the **Magnify** key several times and make the display 1×1.
- 10) Press the **Copy** key, and the currently displayed screen is hard-copied.

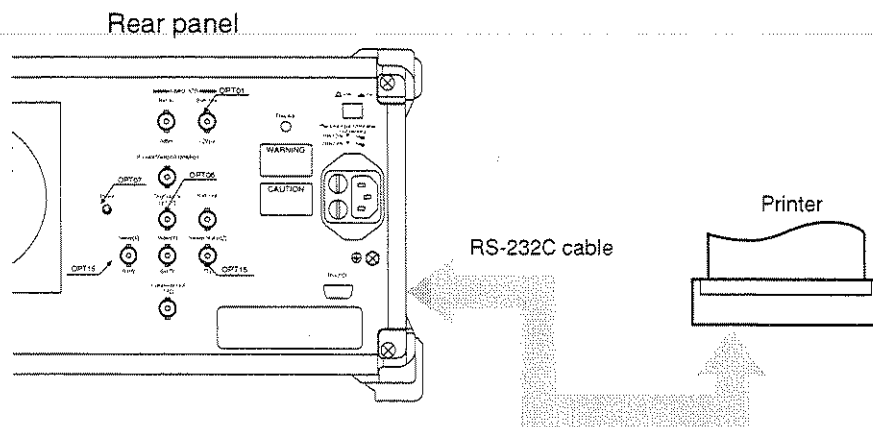

Fig. 5-14



SECTION 6

PERFORMANCE TESTS

In this chapter, measuring instruments, setup and operations necessary for conducting performance tests of MS2650/2660B/C series equipped with a reference oscillator (Option 01) are described. Note that with regard to performance tests of sideband noise level, mean noise level and second harmonic distortion, the standard of measured objects differ between MS2651B/MS2653B and MS2661B/2663B/2661C/2663C.

Also note that with regard to performance tests of Resolution bandwidth accuracy, Resolution bandwidth selectivity, and Resolution bandwidth switching uncertainty, the standard of measured objects differ between MS2651B/2661B/2653B/2663B and MS2661C/MS2663C.

TABLE OF CONTENTS

Requirement for Performance Tests	6-3
Instruments Required for Performance Test	6-4
Performance Test	6-6
Reference oscillator frequency stability	6-6
Frequency readout accuracy	6-8
Frequency span readout accuracy	6-11
Resolution bandwidth (RBW) and selectivity	6-14
Sideband phase noise	6-20
Frequency measurement accuracy	6-22
Amplitude display linearity	6-24
Frequency response	6-28
Reference level accuracy	6-31
Average noise level	6-34
Second harmonic distortion	6-37
Resolution bandwidth (RBW) switching uncertainty	6-40
Input attenuator (RF ATT) switching uncertainty	6-43
Sweep time and time span accuracy	6-46
Tracking generator (TG) output level accuracy	6-50
Service	6-53

SECTION 6 PERFORMANCE TESTS

Requirement for Performance Tests

Performance tests are used as preventive maintenance to prevent degradation of the MS2650/MS2660B/C series performance before it occurs.

Use the performance tests whenever necessary such as at acceptance and periodic inspection of the MS2650/MS2660B/C series and to verify performance after repair. Execute the performance tests listed below to verify the MS2650/MS2660B/C series performance at acceptance inspection, periodic inspection and after repair.

- Reference oscillator frequency stability
- Frequency readout accuracy
- Frequency span readout accuracy
- Resolution bandwidth and selectivity
- Sideband phase noise
- Frequency measurement accuracy
- Amplitude display linearity
- Frequency response
- Reference level accuracy
- Average noise level
- Second harmonic distortion
- Resolution bandwidth (RBW) switching uncertainty
- Input attenuator switching uncertainty
- Sweep time and time span accuracy
- TG output level

Execute the performance tests at regular intervals as preventive maintenance for important evaluation items. We recommend that the performance be inspected regularly once or twice a year.

If the specifications are not met at the performance tests, please contact Anritsu Corporation.

Instruments Required for Performance Test

A list of instruments required for performance test is shown below.

Instruments Required for Performance Test (1/2)

Recommended instrument name (Model name)	Required Performance †	Test item
Synthesized signal generator (MG3633A)	<ul style="list-style-type: none"> • Frequency range 100 MHz to 1 GHz Resolution of 1 Hz possible • Output level range -20 to 0 dBm Resolution of 0.1 dB possible • SSB phase noise ≤ 130 dBc/Hz (at 10 kHz offset) • Second harmonic ≤ 30 dBc • Amplitude modulation (0 % to 100 %, 0.1 to 400 Hz) possible • External reference input (10 MHz) possible 	Frequency-span display accuracy Resolution bandwidth, selectivity Sideband noise Amplitude display linearity Reference-level accuracy Second-harmonic distortion Resolution-bandwidth switching error Input-attenuator switching error Sweep-time and time-span accuracy
Swept Frequency Synthesizer (69269A with Option 2B)	<ul style="list-style-type: none"> • Frequency range 10 MHz to 8.1 GHz Resolution of 2 kHz possible • Output level range -20 to 0 dBm Resolution of 0.1 dB possible • Pulse modulation possible Pulse width: 0.5 to 10 μ sec Repetitive cycle: 5 μ sec to 5 msec • External reference input (10 MHz) possible 	Center-frequency display accuracy Frequency-span display accuracy Frequency measurement accuracy Frequency response Time-span accuracy
Attenuator (MN510C)	<ul style="list-style-type: none"> • Frequency 100 MHz • Maximum attenuation 70 dB (resolution 0.1 dB) possible with calibrated data 	Amplitude display linearity Input-attenuator switching error

† Extracts part of performance which can cover the measurement range of the test item.

Instruments Required for Performance Test (2/2)

Recommended instrument name (Model name)	Required Performance †	Test item
Power meter (ML4803A)	<ul style="list-style-type: none"> • Main instrument accuracy ± 0.02 dB • Frequency range 100 kHz to 8.1 GHz (depending on the power sensor type) 	Frequency response Reference-level accuracy Input-attenuator switching error TG output level
Power sensor (MA4601A)	<ul style="list-style-type: none"> • Frequency range 100 kHz to 2 GHz • Measurement power range -30 to +10 dBm • Input connector N type 	Frequency response Reference-level accuracy Input-attenuator switching error TG output level
Power sensor (MA4701A)	<ul style="list-style-type: none"> • Frequency range 10 MHz to 8.1 GHz • Measurement power range -30 to +10 dBm • Input connector N type 	TG output level
Power Sensor (MA4602A)	<ul style="list-style-type: none"> • Frequency range 100 kHz to 3 GHz • Measurement power range -60 to -30 dBm • Input connector N type 	
50 Ω terminator (MP752A)	<ul style="list-style-type: none"> • Frequency range DC to 8.1 GHz • VSWR ≤ 1.2 	Average noise level
Low-pass filter (M-238C) (SAGE L20CA072)	<ul style="list-style-type: none"> • Attenuation ≥ 70 dB (at frequency: $2 \times$ (10 MHz and 1 GHz)) 	Second-harmonic distortion
Frequency counter (MF1601A)	10 MHz measurement possible Number of display digits: 10 <ul style="list-style-type: none"> • External reference input (10 MHz) possible 	Reference-oscillator frequency stability
Frequency standard	<ul style="list-style-type: none"> • Frequency 10 MHz • Stability $\leq 1 \times 10^{-9}$/day 	Reference-oscillator frequency stability

† Extracts part of performance which can cover the measurement range of the test item.

Performance Test

The warm-up time depends on the test item. For test item other than oscillator frequency, warm-up the equipment for at least for thirty minutes and test the performance after the MS2650/MS2660B/C series stabilizes completely. Also, begin measurement after taking the warm-up time of the calibration instrument into full consideration. In addition, the test must be conducted at room temperature; there must be little AC power supply voltage fluctuation, and no noise, vibration, dust, humidity, etc.

Reference oscillator frequency stability

The optional 10 MHz reference oscillator (Option 01) is tested for frequency stability.

Stability is determined by measuring frequency variation after 24 hours and after 48 hours of power on at ambient temperatures of 0 °C and 50 °C.

If a device is not to mount Option 01, this test is not available since there is no 10 MHz reference buffer output.

(1) Specifications (Option 01)

■ Reference oscillator

- Frequency: 10 MHz
- Aging rate: $\leq \pm 2 \times 10^{-8}/\text{day}$
After 24 hour warm-up at $25 \text{ }^\circ\text{C} \pm 5 \text{ }^\circ\text{C}$
- Temperature stability: $\leq \pm 5 \times 10^{-8}$ at 0 and 50 °C referred to frequency at 25 °C

(2) Test instruments

- Frequency counter: MF1601A
- Frequency standard: with stability of $\leq \pm 1 \times 10^{-9}/\text{day}$

(3) Setup

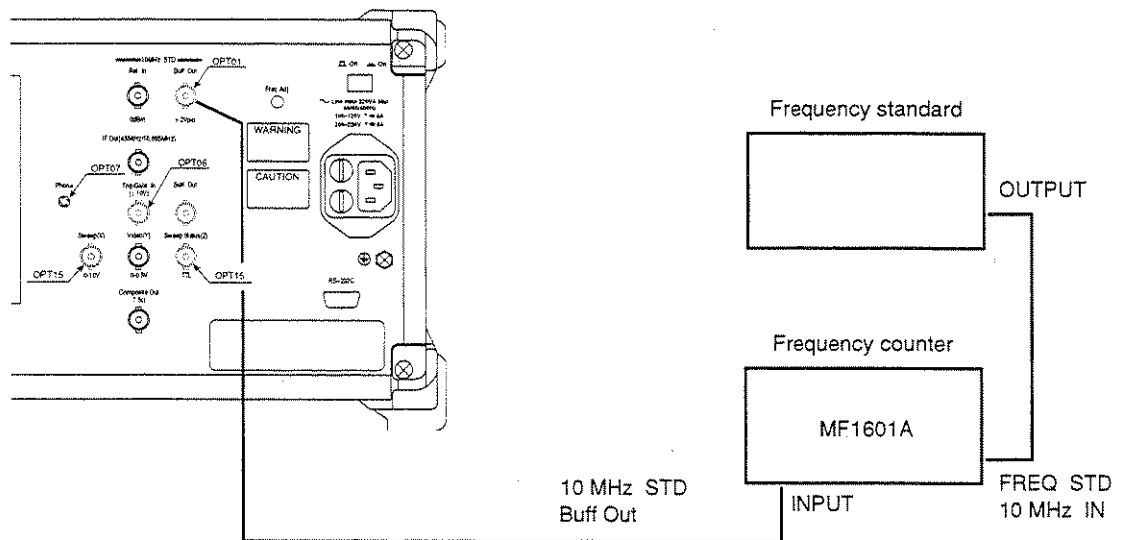
**Reference Oscillator Frequency Stability Test**

(4) Procedure

Aging rate/day: Test this at the ambient temperature ± 2 °C in a vibration-free place.

Step	Procedure
1	Set the change over switch (FREQ STD: INT/EXT) on the MF1601A counter rear panel to EXT.
2	Set the power supply switch on the spectrum analyzer rear panel to On and then the Power switch on the spectrum analyzer front panel to On.
3	Measure the frequency using the counter with 0.1 Hz resolution after 24 hours have passed after turning the power ON.
4	Measure the frequency using the counter after 24 more hours have passed from the step 3 measurement.
5	Calculate the stability by using the following equation.
	$\text{Frequency stability} = \frac{(\text{2nd reading of the counter}) - (\text{1st reading of the counter})}{(\text{1st reading of the counter})}$

Temperature stability: Test this performance in a vibration-free constant-temperature chamber.

Step	Procedure
1	Set up the spectrum analyzer in a constant-temperature chamber at 25 °C in the same setup.
2	Set the LINE and Power switches on the spectrum analyzer to On and wait until the spectrum analyzer internal temperature stabilizes (approx. 1.5 hours after the chamber temperature stabilizes).
3	When the internal temperature stabilizes, measure the frequency by using the counter with 0.1 Hz resolution.
4	Change the chamber temperature to 50 °C.
5	When the chamber temperature and the spectrum analyzer internal temperature re-stabilize, measure the frequency by using the counter.
6	Calculate the stability by using the following equation. $\text{Temperature stability} = \frac{(\text{counter reading at } 50 \text{ }^\circ\text{C}) - (\text{counter reading at } 25 \text{ }^\circ\text{C})}{(\text{counter reading at } 25 \text{ }^\circ\text{C})}$
7	Change the chamber temperature to 0 °C and repeat steps 5 and 6.

Frequency readout accuracy

Add the known frequency which serves as the center frequency reference to the spectrum analyzer as shown in the figure below and set CF (same value as the known reference frequency) and SPAN. At this time, check that the difference between the reading of the marker readout frequency (thick arrow in the figure) of the center frequency peak point, and the CF set value is $\leq \pm (\text{span} \times \text{span accuracy} + 100 \text{ Hz})$.

As shown in the figure, the Synthesized Signal Generator uses the signal source phase-locked with the same accuracy as the 10 MHz reference oscillator of the spectrum analyzer.

(1) Specifications

- Frequency readout accuracy: $\pm (\text{Readout frequency} \times \text{reference frequency accuracy} + \text{span} \times \text{span accuracy} + 100 \text{ Hz})$; * Span $\geq 10 \text{ kHz}$ (after calibration)

(2) Test instruments

- Synthesized signal generator: 69269A

(3) Setup

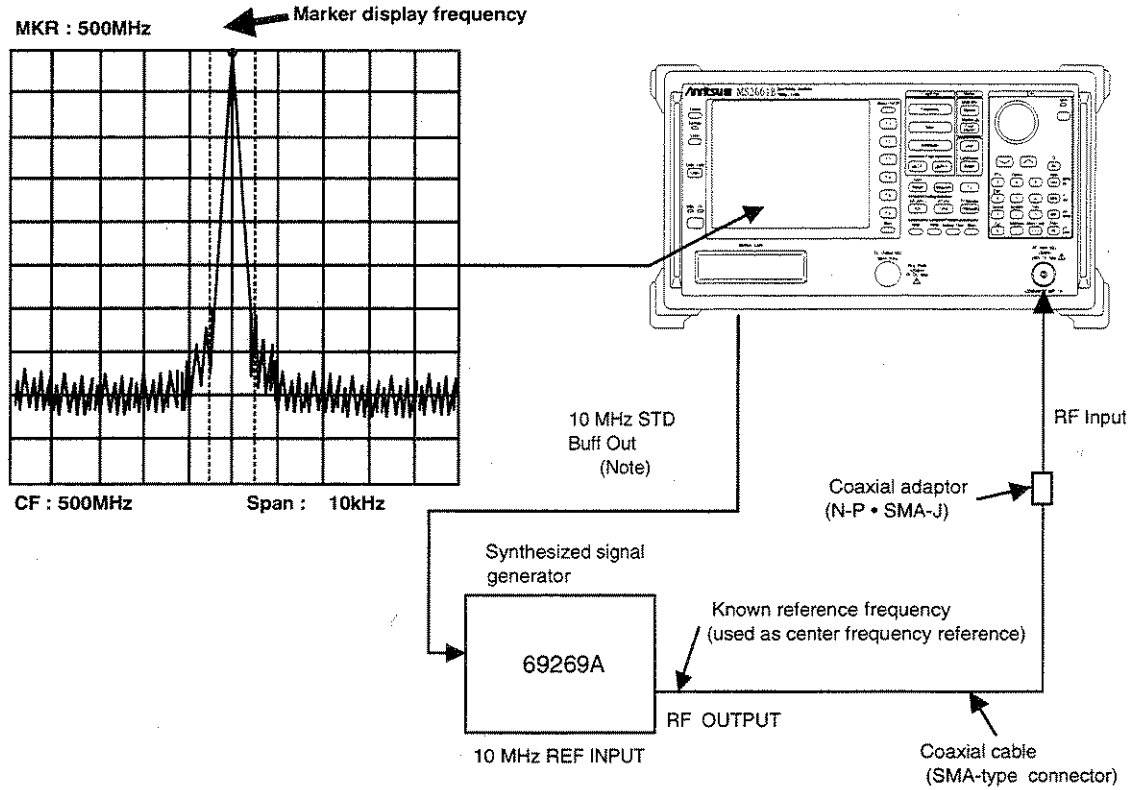

Center-Frequency Readout-Accuracy Test

(Note) If there is no buffer output for the reference oscillator (Option 01) on the rear panel, input a reference signal from an external 10 MHz frequency standard to the main body and signal generator, as shown below.

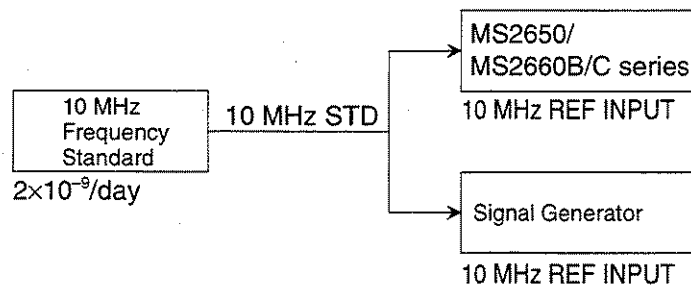

(4) Precautions

Set the signal generator output level to approx -10 to -20 dBm.

(5) Procedure

Step	Procedure
1	Press the spectrum analyzer [Preset] key.
2	Operate Freq Cal.
3	Set the signal generator output frequency equal to the center frequency (500 MHz) in the following table.
4	Set the spectrum analyzer to the center frequency in the following table.
5	Set the span (10 kHz) that corresponds to the center frequency (500 MHz) in the table by using the numeric/unit keys.
6	Read the marker frequency (indicated by thick arrow in the figure on the previous page) and check that the value is within the range between the maximum and minimum values shown in the following table.
7	Repeat steps 3 to 6 for other combination of the center frequency and span according to the combinations shown in the following table.

Frequency readout accuracy test

• MS2651B/2661B/2661C

Signal generator	Center frequency	Span frequency	Center frequency		
			Minimum value	Marker value	Maximum value
500 MHz	500 MHz	10 kHz	499.999 66 MHz		500.000 34 MHz
		200 kHz	499.995 2 MHz		500.004 8 MHz
		100 MHz	497.6 MHz		502.4 MHz

• MS2653B/2663B/2663C

Signal generator	Center frequency	Span frequency	Band	Center frequency		
				Minimum value	Marker value	Maximum value
500 MHz	500 MHz	10 kHz	0	499.999 66 MHz		500.000 34 MHz
		200 kHz		499.995 2 MHz		500.004 8 MHz
		100 MHz		497.6 MHz		502.4 MHz
5 GHz	5 GHz	10 kHz	1 ⁻	4.999 999 66 GHz		5.000 000 34 GHz
		200 kHz		4.999 995 2 GHz		5.000 004 8 GHz
		100 MHz		4.997 6 GHz		5.002 4 GHz
7.5 GHz	7.5 GHz	10 kHz	1 ⁺	7.499 999 66 GHz		7.500 000 34 GHz
		200 kHz		7.499 995 2 GHz		7.500004 8 GHz
		100 MHz		7.497 6 GHz		7.502 4 GHz

Frequency span readout accuracy

Using the setup shown in the figure below, set the frequencies corresponding the 1st and 9th division from the left side of the screen scale with the SG. The frequency difference between the peak levels at the 1st and 9th divisions is equal to the frequency span \times 0.8.

(1) Specifications

- Frequency span accuracy: $\pm 2.5\%$ (span ≥ 10 kHz)

(2) Test instrument

- Synthesized signal generator: MG3633A
69269A

(3) Setup

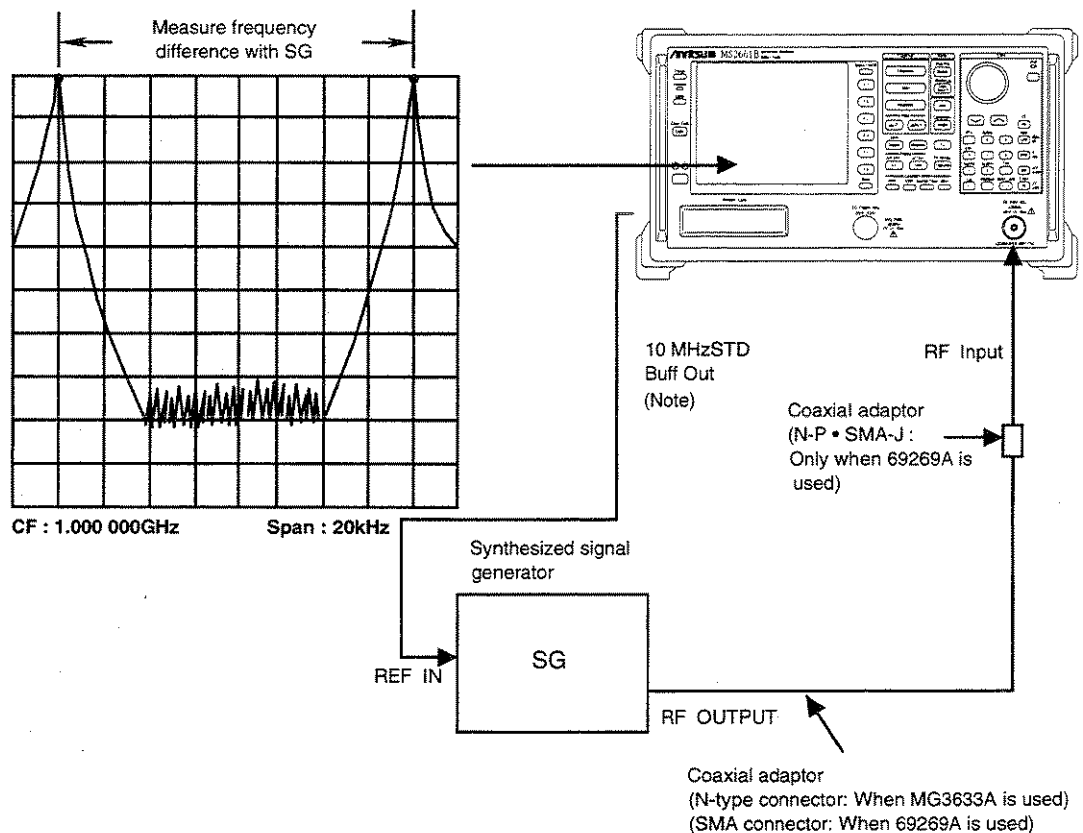

Frequency Readout Accuracy Test

- (Note) If there is no buffer output for the reference oscillator (Option 01) on the rear panel, input a reference signal from an external 10 MHz frequency standard to the main body and signal generator.

(4) Precautions

Set the signal generator output level to approx. -10 to -20 dBm.

(5) Procedure

Step	Procedure
1	Press the [Preset] key.
2	Operate Freq Cal.
3	Connect the MG3633A output to the spectrum analyzer RF Input.
4	Set the spectrum analyzer as shown below: Span 20 kHz Center Freq 1000 MHz
5	Set the MG3633A output frequency to the f_1 frequency (999.992 MHz) shown in the table on the next page.
6	Adjust the MG3633A output frequency to set the spectrum peak at the 1st division from the left end of the screen scale. Remember the frequency as f_1' .
7	After setting the MG3633A output frequency to the f_2 frequency (1000.008 MHz), adjust it to set the spectrum peak at the 9th division. Remember the frequency as f_2' .
8	Calculate $(f_2' - f_1')/0.8$ and check that the value is within the specified range (minimum to maximum values) shown in the table on the next page.
9	Repeat steps 4 through 8 for each frequency span with 1 GHz center frequency shown in the table on the next page.

Frequency-Span Readout-Accuracy Test

MS2651B/2661B/2661C		Signal generator				
Center frequency	Span	f_1	f_2	Minimum value	$\frac{f_2 - f_1}{0.8}$	Maximum value
1 GHz	20 kHz	0.999 99 2 GHz	1.000 008 GHz	19.5 kHz		20.5 kHz
	200 kHz	0.999 92 GHz	1.000 08 GHz	195 kHz		205 kHz
	2 MHz	0.999 2 GHz	1.000 8 GHz	1.95 MHz		2.05 MHz
	10 MHz	0.996 GHz	1.004 GHz	9.75 MHz		10.25 MHz
	100 MHz	0.96 GHz	1.04 GHz	97.5 MHz		102.5 MHz
	2 GHz	0.2 GHz	1.8 GHz	1.95 GHz		2.05 GHz

MS2653B/2663B/2663C		Signal generator				
Center frequency	Span	f_1	f_2	Minimum value	$\frac{f_2 - f_1}{0.8}$	Maximum value
1 GHz	20 kHz	0.999 99 2 GHz	1.000 008 GHz	19.5 kHz		20.5 kHz
	200 kHz	0.999 92 GHz	1.000 08 GHz	195 kHz		205 kHz
	2 MHz	0.999 2 GHz	1.000 8 GHz	1.95 MHz		2.05 MHz
	10 MHz	0.996 GHz	1.004 GHz	9.75 MHz		10.25 MHz
	100 MHz	0.96 GHz	1.04 GHz	97.5 MHz		102.5 MHz
	2 GHz	0.2 GHz	1.8 GHz	1.95 GHz		2.05 GHz
4.05 GHz	100 MHz	4.01 GHz	4.09 GHz	97.5 MHz		102.5 MHz
	1 GHz	3.65 GHz	4.45 GHz	0.975 GHz		1.025 GHz
	8.1 GHz	0.81 GHz	7.29 GHz	7.8975 GHz		8.3025 GHz

Resolution bandwidth (RBW) and selectivity

If there are two input signals with the frequency difference corresponding to 3 dB bandwidth (of IF final stage), these signals can be resolved as two spectrum waveforms.

This is called the resolution bandwidth.

Selectivity can be improved by narrowing the 60 dB bandwidth. The selectivity is defined by the ratio of the filter width, in Hz, at the -60 dB point, to the filter width, in Hz, at the -3 dB point, as shown in the formula below.

$$\text{Selectivity} = \frac{60 \text{ dB bandwidth (Hz)}}{3 \text{ dB bandwidth (Hz)}}$$

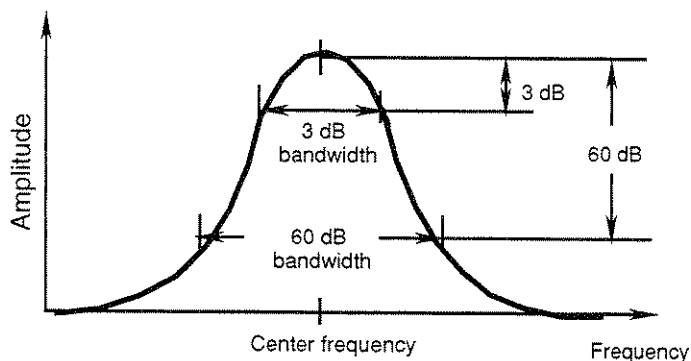

To test the resolution bandwidth and selectivity, first measure the resolution bandwidth (3 dB bandwidth), then the 60 dB bandwidth and calculate the 60 dB/3 dB bandwidth ratio.

(1) Specifications

- Resolution bandwidth accuracy (MS2661C/2663C only):
 - ±20 % (RBW=1 kHz to 1 MHz)
 - ±30 % (RBW=3 MHz)
- Selectivity (60 dB/3 dB bandwidth):
 - MS2651B/2661B/2653B/2663B
 - ≤15:1 (RBW=1 MHz, 3 MHz)
 - ≤10:1 (RBW=1 kHz to 300 kHz)
 - MS2661C/2663C
 - ≤15:1 (RBW=1 kHz to 3 MHz)

(2) Test instrument

- Synthesized signal generator: MG3633A

(3) Setup

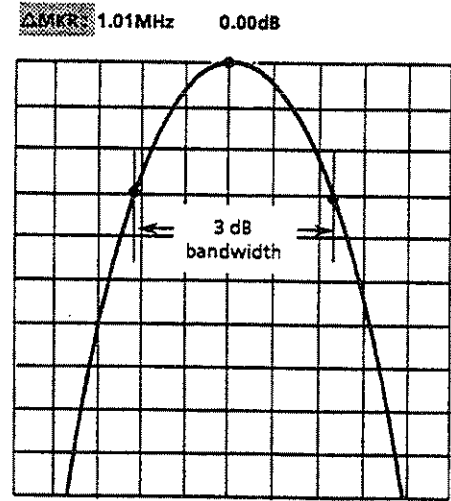
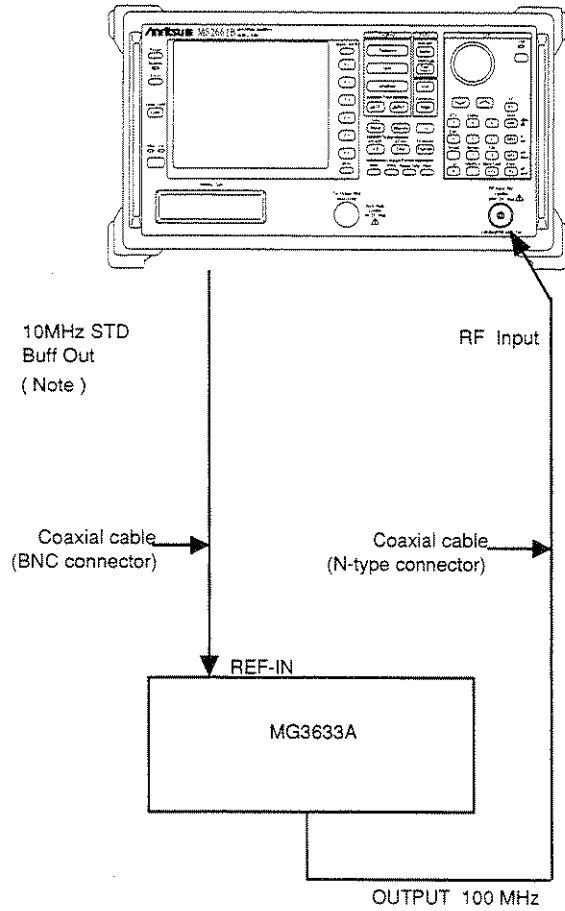

(a) Resolution bandwidth

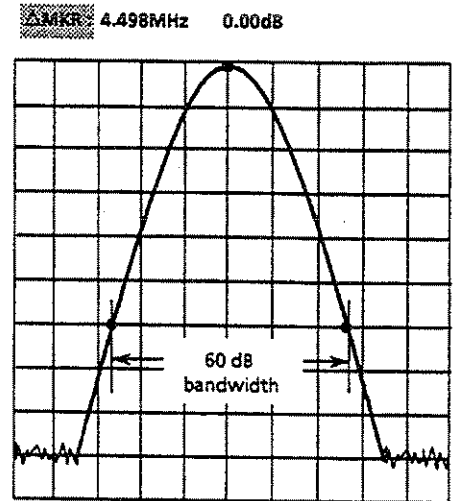

(b) 60 dB dropped bandwidth

Resolution Bandwidth/Selectivity Test

(4) Procedure

(a) Resolution bandwidth accuracy

Step	Procedure
1	Press the [Preset] key.
2	Perform all calibration.
3	Set the spectrum analyzer as shown below: Center Freq 100 MHz Span 5 MHz RBW (MANUAL) 1 MHz Scale LOG 1 dB/div
4	Press the [→RLV] key and match the peak of the signal trace to the top line (REF LEVEL) on the screen.
5	Press the [Single] key to execute a single sweep, then check that the single sweep has been completed.
6	After pressing the Measure key, operate Occ BW Measure and Setup and display the setup menu of occupied frequency bandwidth measurement.
7	Select X dB Down and set it to 3 dB.
8	Press Return to return to the Occ BW Measure menu, and then press Execute.
9	The 3 dB resolution bandwidth value is displayed in the upper left-hand corner of the screen. Fill in this value in the table on the next page.
10	Repeat steps 3 to 9 for the frequencies other than the resolution bandwidth 1 MHz and the frequency span 5 MHz according to the combinations of resolution bandwidth and frequency span shown in the table on the next page.

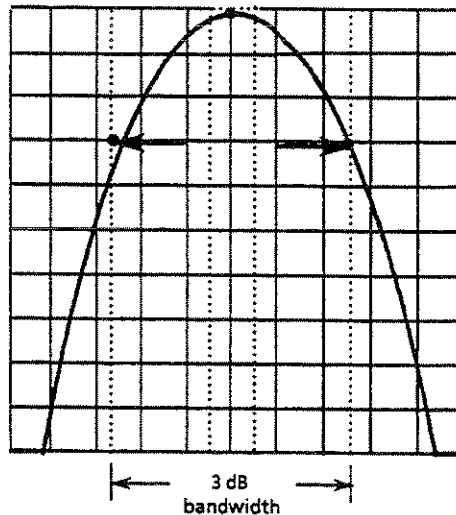

Bandwidth Measurement

Resolution Bandwidth (3 dB)

- MS2651B/2661B/2653B/2663B

Resolution bandwidth	Frequency span	3 dB bandwidth
5 MHz	10 MHz	
1 MHz	5 MHz	
300 kHz	500 kHz	
100 kHz	200 kHz	
30 kHz	50 kHz	
10 kHz	20 kHz	
3 kHz	5 kHz	
1 kHz	2 kHz	

- MS2661C/2663C

Resolution bandwidth	Frequency span	3 dB bandwidth
3 MHz	10 MHz	
1 MHz	5 MHz	
300 kHz	500 kHz	
100 kHz	200 kHz	
30 kHz	50 kHz	
10 kHz	20 kHz	
3 kHz	5 kHz	
1 kHz	2 kHz	

(b) Resolution bandwidth selectivity

Step	Procedure
1	Set the spectrum analyzer as shown below: Center Freq 100 MHz Span 20 MHz RBW (MANUAL) 1 MHz Scale LOG 10 dB/div VBW 100 Hz Marker NORMAL Zone Width 1 div
2	Press the [→RLV] key to match the peak of the signal trace to the top line (REF LEVEL) on the screen.
3	Press the [Single] key to execute a single sweep, then check that the single sweep has been completed.
4	After pressing the Measure key, operate Occ BW Measure and Setup and display the setup menu of occupied frequency bandwidth measurement.
5	Select X dB Down and set it to 60 dB.
6	Press Return to return to the Occ BW Measure menu, and then press Execute.
7	The 60 dB resolution bandwidth value is displayed in the upper left-hand corner of the screen. Fill in this value in the table on the next page.
8	Repeat steps 1 to 7 for the frequencies other than the resolution bandwidth 1 MHz and the frequency span 20 MHz according to the combinations of resolution bandwidth and frequency span shown in the table on the next page.
9	For the 3 dB bandwidth, too, write the value of the Resolution Bandwidth (3 dB) table on the preceding page in the table on the next page.
10	For each resolution bandwidth in the table on the next page, confirm that the value calculated from (60 dB BW/3 dB BW) is ≤ 15 or ≤ 10 .

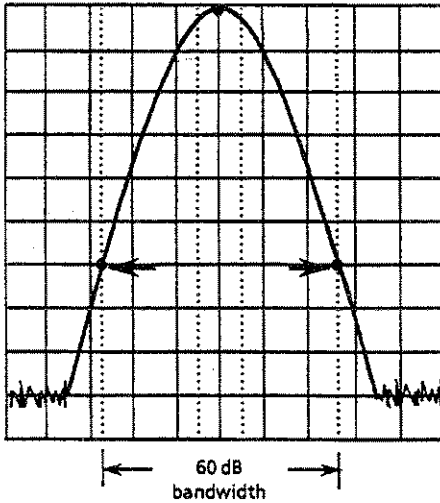

60 dB Bandwidth Measurement

Selectivity Test (60 dB/3 dB Bandwidth Ratio)

• MS2651B/2661B/2653B/2663B

Resolution bandwidth	Frequency span	Video bandwidth	60 dB BW	3 dB BW	60 dB BW/30 dB BW
5 MHz	100 MHz	100 Hz			≤15
1 MHz	20 MHz	100 Hz			≤15
300 kHz	10 MHz	100 Hz			≤10
100 kHz	5 MHz	100 Hz			≤10
30 kHz	1 MHz	100 Hz			≤10
10 kHz	200 kHz	100 Hz			≤10
3 kHz	100 kHz	100 Hz			≤10
1 kHz	50 kHz	100 Hz			≤10

• MS2661C/2663C

Resolution bandwidth	Frequency span	Video bandwidth	60 dB BW	3 dB BW	60 dB BW/30 dB BW
3 MHz	100 MHz	100 Hz			≤15
1 MHz	20 MHz	100 Hz			≤15
300 kHz	10 MHz	100 Hz			≤15
100 kHz	5 MHz	100 Hz			≤15
30 kHz	1 MHz	100 Hz			≤15
10 kHz	200 kHz	100 Hz			≤15
3 kHz	100 kHz	100 Hz			≤15
1 kHz	50 kHz	100 Hz			≤15

Sideband phase noise

When the resolution bandwidth is set to a fixed value and a signal that has far less sideband-noise level than the equipment to be tested is input, check the level of the noise as compared to the peak signal (dBc) at the specified frequency away from the peak.

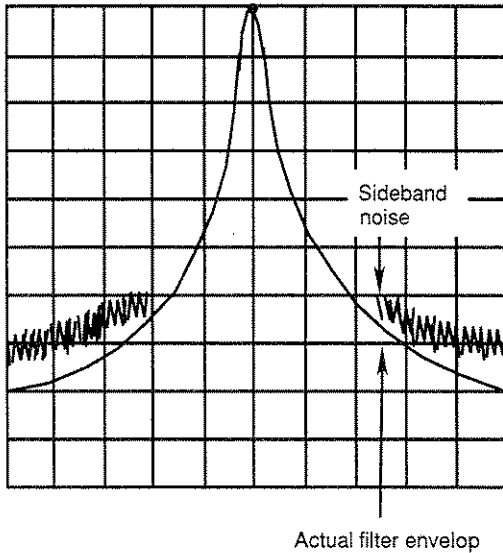

Since the average value is measured for noise level, use a video filter for measurement.

This sideband noise is a spectrum response which is modulated by the internal noise of the spectrum analyzer. If this response is large, the actual filter envelope is masked by the noise as shown, which makes measurement impossible.

(1) Specifications

- Sideband noise: ≤ 100 dBc/Hz (Frequency: 1 GHz, 10 kHz offset; MS2661B/2663B/2661C/2663C)
 ≤ 90 dBc/Hz (Frequency: 1 GHz, 10 kHz offset; MS2651B/2653B)

(2) Test instruments

- Signal generator: MG3633A Synthesized Signal Generator

(3) Setup

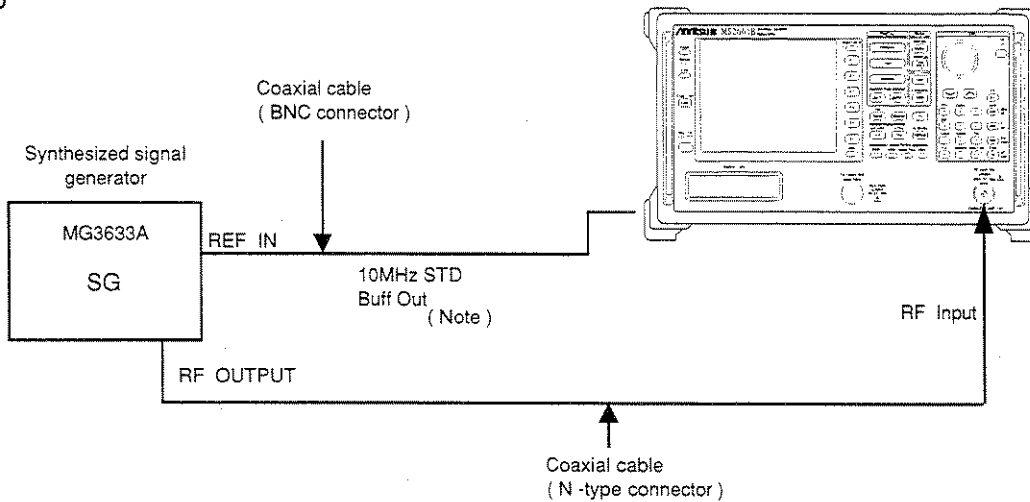

Sideband Noise Test

(4) Procedure

Step	Procedure
1	Press the [Preset] key.
2	Operate All Cal.
3	Set the MG3633A output to 1000 MHz and 0 dBm.
4	Set the spectrum analyzer as shown below: Center Freq 1.000 010 GHz Span 25 kHz Reference Level 0 dBm Attenuator 10 dB RBW 1 kHz VBW 10 Hz DET MODE SAMPLE
5	Press the [Peak Search] key to search for a peak point so that the peak point on the signal trace is included in the zone marker.
6	Press the [\rightarrow RLV] key to match the peak of the signal trace to the top line (REF LEVEL) on the screen.
7	After pressing the Measure key, select C/N Ratio Measure.
8	Press the Meas On key to start C/N measurement.
9	Set Zone Width of Marker to Spot.
10	Press the [Marker] key, then turn the rotary knob to move the zone marker to the right so that the zone center frequency is 10.0 kHz.
11	Make sure that the C/N value is -100 dBc/Hz or less (MS2661B/2663B/2661C/2663C) or -90 dBc/Hz or less (MS2651B/2653B).

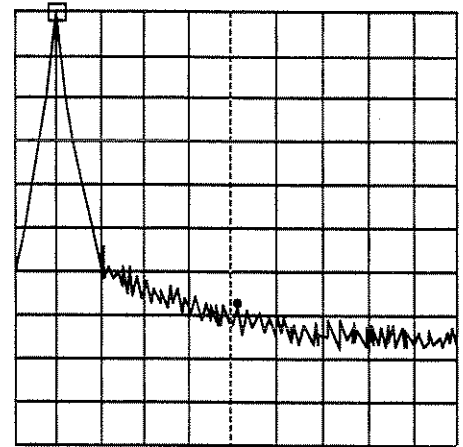

CF : 1.000 010GHz

Span : 25kHz

Sideband Noise Measurement

Frequency measurement accuracy

Set the marker point to the position at least 20 dB higher than the noise (or adjacent interference signal) to operate the built-in counter with the higher-S/N signal, and test the frequency measurement accuracy using Count On mode.

(1) Specifications

- Accuracy: $\leq (\text{Readout frequency} \times \text{reference oscillator accuracy} \pm (1 \text{ count}))$
- Resolution: 1 Hz, 10 Hz, 100 Hz, 1 kHz

(2) Test instrument

- Signal generator: 69269A

(3) Setup

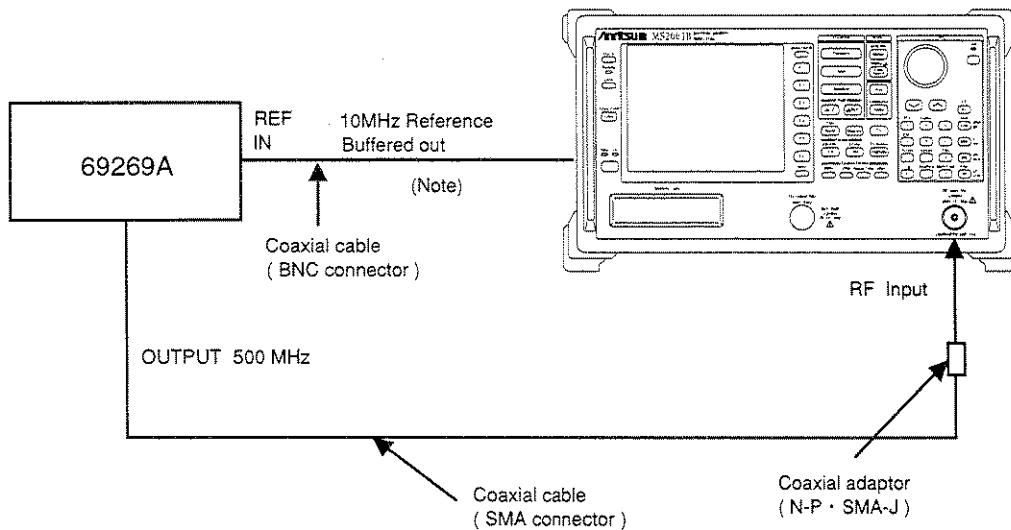

Frequency Measurement Accuracy Test

(Note) If there is no buffer output for the reference oscillator (Option 01) on the rear panel, input a reference signal from an external 10 MHz frequency standard to the main body and signal generator.

(4) Procedure

Step	Procedure
1	Press the [Preset] key.
2	Set the 69269A to 500 MHz and -10 dBm.
3	Set the spectrum analyzer as shown below: Center Freq 500 MHz Span 50 kHz
4	Press the [Measure] key and set to Frequency Count. Press Setup and set Resolution to 1 Hz. Then, press the Return key and set to Count On.
5	Confirm that the FREQ reading at the upper-left of the screen is the RF INPUT frequency 500 MHz \pm 1 Hz or less.
6	Change the counter resolution to 10 Hz and confirm that the Freq reading is 500 MHz \pm 10 Hz or less.
7	<ul style="list-style-type: none"> Change the counter resolution to 100 Hz and confirm that the Freq reading is 500 MHz \pm 100 Hz or less. Change the counter resolution to 1 kHz and confirm that the Freq reading is 500 MHz \pm 1 kHz or less.

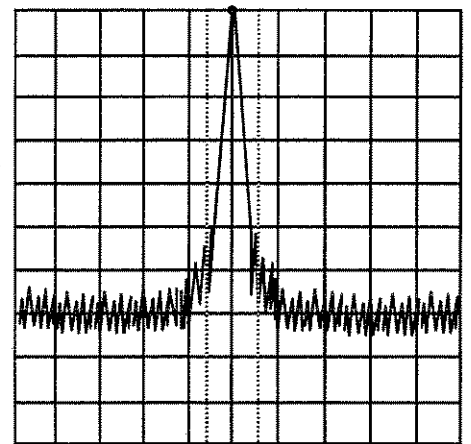

CF : 500MHz Span : 50kHz

Frequency Measurement

Amplitude display linearity

Test the error per vertical graduation for the LOG display. For the LOG display linearity, test that the graduation is equal to the logarithm (dB) of the input signal level.

Input the correct level signal to the RF Input via an external attenuator and calculate the error from the attenuation of the attenuator and the Δ marker reading at the trace waveform peak.

(1) Specifications

- Amplitude display linearity:

	After automatic calibration
LOG:	± 2.5 dB for 0 to -90 dB
	± 1.5 dB for 0 to -85 dB
	± 1 dB for 0 to -70 dB
	± 0.4 dB for 0 to -20 dB

(2) Test instruments

- Signal generator: MG3633A
- Attenuator: MN510C

(3) Setup

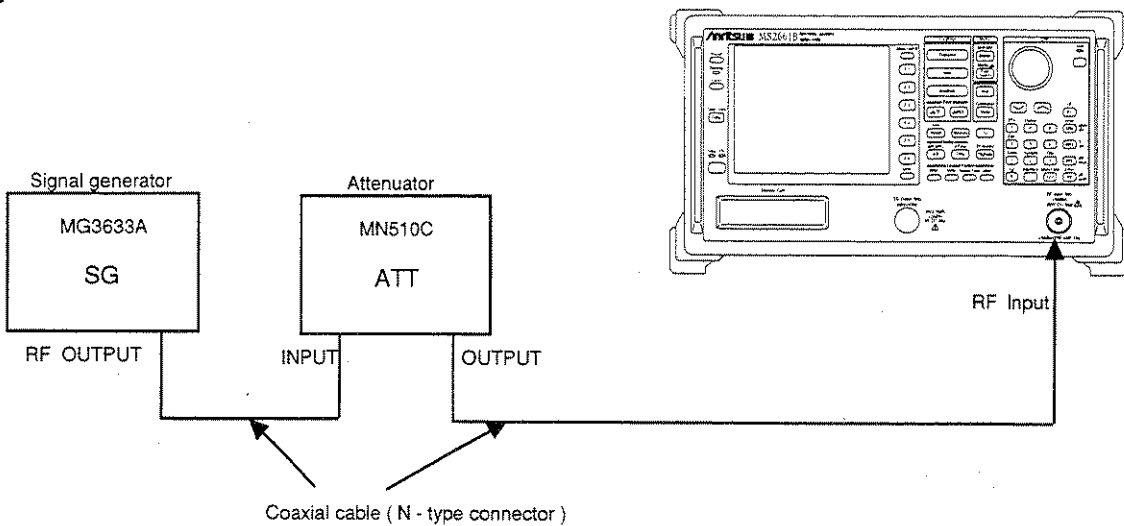

Amplitude Display Linearity Test

(4) Procedure

LOG display linearity

Step	Procedure
1	Press the [Preset] key.
2	Operate All Cal.
3	Set the MG3633A to 100 MHz and 0 dBm.
4	Set the MN510C to 0 dB.
5	Set the spectrum analyzer as shown below: Center Freq 100 MHz Span 10 kHz Reference Level 0 dBm Attenuator 10 dB RBW 3 kHz VBW 300 Hz
6	Press the [\rightarrow CF] key to set the spectrum waveform peak to the center of the screen.
7	Adjust the MG3633A output level so that the marker level reading is 0.0 dBm.
8	Press the [Marker] key sequentially to set the marker to Δ marker after the sweep is completed.

Step	Procedure
9	As shown on Fig. (b), read the level of the current marker when ATT is set at 5 dB. An error is determined as calibrated ATT 5 dB value + Δ marker level.
10	Add a marker level corresponding to the calibrated ATT value when ATT is set as 10 to 90 DB (with 5 dB steps) and determine the error.

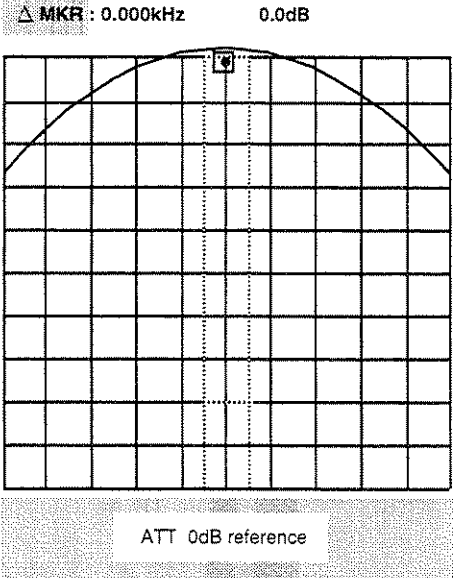

(a) Reference Point Setting

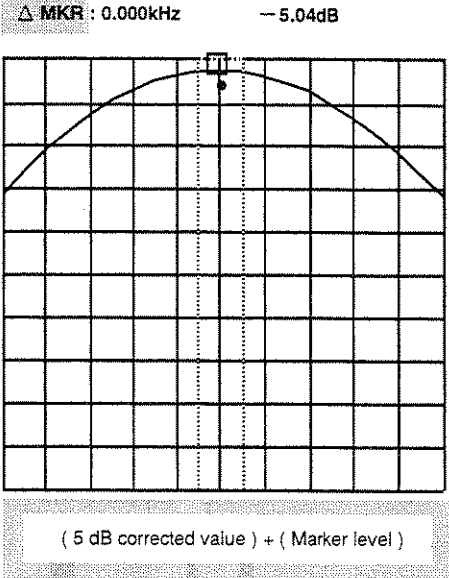

(b) Δ Marker Level when ATT is 5

Log Display Linearity (10 dB/div)

ATT setting (dB)	A	B	Error (dB)=A+B
	ATT calibration value (dB)	Δ marker level (dB)	
0	0 (reference)	0 (reference)	0 (reference)
5	_____	_____	_____
10	_____	_____	_____
15	_____	_____	_____
20	_____	_____	_____
25	_____	_____	_____
30	_____	_____	_____
35	_____	_____	_____
40	_____	_____	_____
45	_____	_____	_____
50	_____	_____	_____
55	_____	_____	_____
60	_____	_____	_____
65	_____	_____	_____
70	_____	_____	_____
75	_____	_____	_____
80	_____	_____	_____
85	_____	_____	_____
90	_____	_____	_____

Frequency response

Generally, when one or more signals with a different frequency but the same amplitude are input, the spectrum analyzer displays the same amplitude for each spectrum on the screen.

(1) Specifications

- Frequency response:
 - MS2651B/2661B/2661C Referenced to 100 MHz, RF ATT 10 dB and temperature range 18 to 28 °C
±0.5 dB (100 kHz to 3 GHz)
 - MS2653B/2663B/2663C ±0.5 dB (100 kHz to 3.2 GHz, band 0, Referenced to 100 MHz, RF ATT: 10 dB, temperature range: 18 to 28 °C)
±1.5 dB (9 to 100 kHz, band 0, Referenced to 100 MHz, RF ATT: 10 dB, temperature range: 18 to 28 °C)
±1.5 dB (2.92 to 8.1 GHz, band 1-/1+, Referenced to 100 MHz, RF ATT: 10 dB, temperature range: 18 to 28 °C)
± 1.0 dB (100 kHz to 3.2 GHz, band 0, RF ATT: 10 to 50 dB)
± 3.0 dB (2.92 to 8.1 GHz, band 1-/1+, RF ATT: 10 to 50 dB)
* In the band 1- and 1+, after the pre-selector is tuned.....

(2) Test instruments

- Signal generator: 69269A
- Power meter: ML4803A
- Power sensor: MA4601A (For the MS2651B/2661B/2661C)
MA4701A (For the MS2653B/2663B/2663C)

(3) Setup

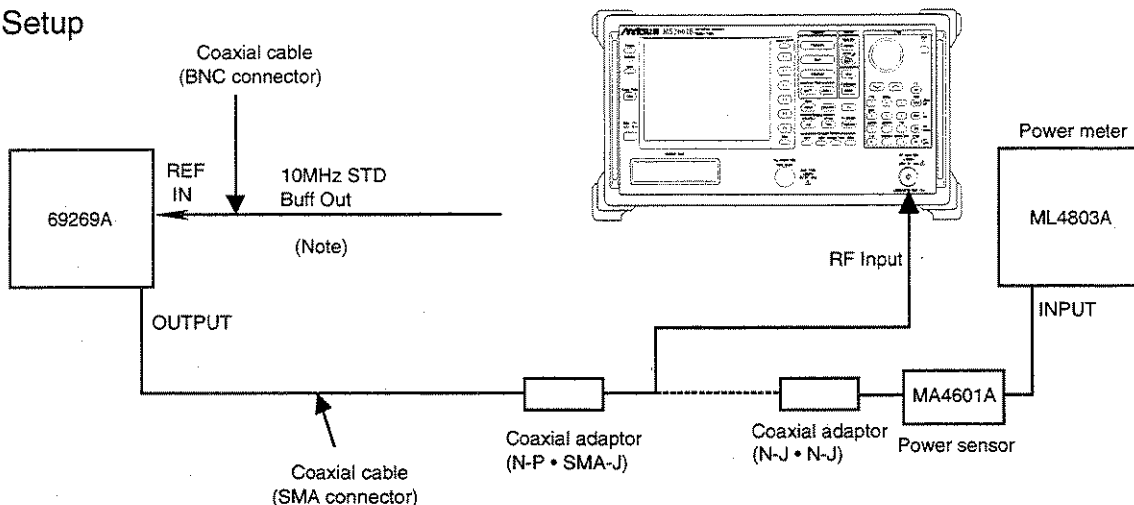

(Note) If there is no buffer output for the reference oscillator (Option 01) on the rear panel, input a reference signal from an external 10 MHz frequency standard to the main body and signal generator.

Frequency Response Test

(4) Precautions

This test should be performed at an ambient temperature of 10 ° to 28 °C after allowing the instrument to warm up for 60 minutes or more.

(5) Procedure

(a) Calibration of signal-generator 69269A

Step	Procedure
1	Set the 69269A as shown below: OUTPUT FREQ 100 MHz OUTPUT LEVEL -10 dBm
2	Connect the 69269A output to the power sensor input with a coaxial cable.
3	Read the power meter display.
4	Change the 69269A output frequency as shown in the tables on the next page and read the power meter display with level at 100 MHz as reference. This data is the calibration data.

(b) Readout of measured amplitude deviation (frequency response)

Step	Procedure
1	Connect the 69269A OUTPUT to the spectrum analyzer RF Input with a coaxial cable.
2	Press the spectrum analyzer [Preset] key.
3	Perform all calibration.
4	Set the spectrum analyzer as shown below: Center Freq 100 MHz Span 200 kHz Reference Level -10 dBm
5	Press the [→ CF] key.
6	Set the marker mode to delta marker.
7	Set the spectrum analyzer center frequency as shown in the tables on the next page, then obtain the deviation from the formula below by reading the delta marker level at each frequency. Deviation = Delta marker level reading - Measurement frequency calibration value For Band 1- and 1+, the pre-selector is peaked. (See Chapter 8 of Vol.2, "Detailed Panel Operation.")

Frequency Response

• MS2651B/2661B/2661C

Frequency	Calibration value (dBm)	Marker level (dB)	Deviation (dB)
100 MHz	0 dB (reference)	0 dB (reference)	0 dB (reference)
200 MHz	_____	_____	_____
500 MHz	_____	_____	_____
1 GHz	_____	_____	_____
1.5 GHz	_____	_____	_____
2 GHz	_____	_____	_____

Frequency Response (Band 0)

• MS2653B/2663B/2663C

Frequency	Calibration value (dBm)	Marker level (dB)	Deviation (dB)
100 MHz	0 dB (reference)	0 dB (reference)	0 dB (reference)
200 MHz	_____	_____	_____
500 MHz	_____	_____	_____
1 GHz	_____	_____	_____
1.5 GHz	_____	_____	_____
2 GHz	_____	_____	_____
3 GHz	_____	_____	_____

Frequency Response (Band 1-)

Frequency	Calibration value (dBm)	Marker level (dB)	Deviation (dB)
3.1 GHz	_____	_____	_____
4 GHz	_____	_____	_____
5 GHz	_____	_____	_____
6 GHz	_____	_____	_____
6.5 GHz	_____	_____	_____

Frequency Response (Band 1+)

Frequency	Calibration value (dBm)	Marker level (dB)	Deviation (dB)
6.5 GHz	_____	_____	_____
7 GHz	_____	_____	_____
7.5 GHz	_____	_____	_____
8 GHz	_____	_____	_____

Reference level accuracy

Here the absolute amplitude level at only 100 MHz is tested. Confirm the level accuracy after inputting an SG output (calibrated by a standard power meter) to the MS2650/MS2660B/C series.

(1) Specifications

- Reference level accuracy: At 100 MHz frequency and 1 MHz span after automatic calibration (Resolution bandwidth, video bandwidth, RF ATT and sweep time set to AUTO)
 - $\leq \pm 0.4$ dB (0 to -49.9 dBm)
 - $\leq \pm 0.75$ dB (-69.9 to -50 dBm, 0.1 to +30 dBm)
 - $\leq \pm 1.5$ dB (-80 to -70 dBm)

(2) Test instruments

- Signal generator: MG3633A
- Attenuator: MN510C
- Power sensor: MA4601A
- Power meter: ML4803A

(3) Setup

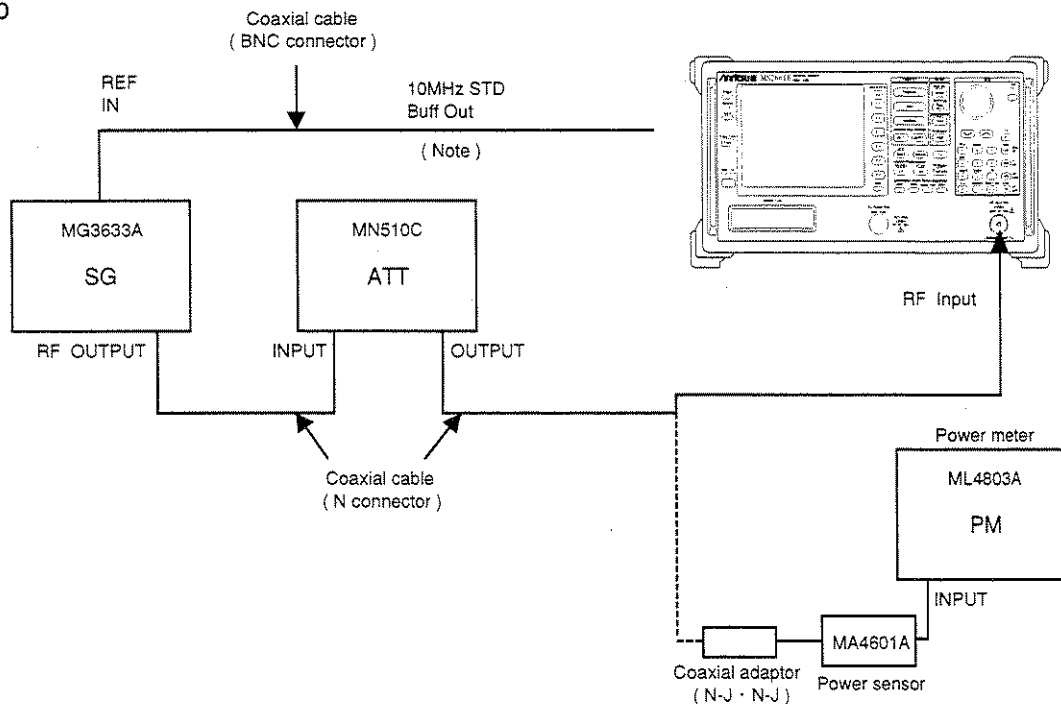

Reference Level Accuracy Test

- (Note) If there is no buffer output for the reference oscillator (Option 01) on the rear panel, input a reference signal from an external 10 MHz frequency standard to the main body and signal generator.

(4) Precautions

- 1) Set the resolution bandwidth, video bandwidth, RF ATT and sweep time to Auto.
- 2) This test should be performed after warming up this instrument for 60 minutes or more.

(5) Procedure

Step	Procedure
1	Press the spectrum analyzer [Preset] key.
2	Operate All Cal.
3	Connect the attenuator OUTPUT to the power sensor input.
4	Set the SG frequency to 100 MHz and adjust the SG level so that the power meter indication is 0 dBm. At this time, set the attenuator to 0 dB.
5	Connect the attenuator OUTPUT to the spectrum analyzer RF Input connector.
6	Set the spectrum analyzer as shown below: Center Freq 100 MHz Span 1 MHz Reference Level 0 dBm
7	Press the [→ CF] to move the peak point of the spectrum waveform to the center of the screen.
8	Read the marker level.

Step	Procedure
9	Change the attenuator in 10 dB steps, set the reference level as shown in the table below and read the marker level each time.

Reference level setting	Marker readout	Correction factor of ATT	Error
0 dBm	dBm	dB	dB
-10 dBm	dBm	dB	dB
-20 dBm	dBm	dB	dB
-30 dBm	dBm	dB	dB
-40 dBm	dBm	dB	dB
-50 dBm	dBm	dB	dB
-60 dBm	dBm	dB	dB
-70 dBm	dBm	dB	dB
-80 dBm	dBm	dB	dB

- 10 Calculate the error from the following equation.

$$\text{Error} = \text{Marker readout} - \text{reference level set value} - \text{correction factor of ATT}$$

Average noise level

The internal noise distributed evenly in proportion to the resolution bandwidth over the whole measurement frequency band is called the average noise level.

(1) Specifications

- Average noise level: At 1 kHz resolution bandwidth, 1 Hz video bandwidth, and 0 dB RF ATT:
 - MS2661B/2661C
 - ≤ -115 dBm (1 MHz to 1 GHz)
 - ≤ -115 dBm + f [GHz] dB (>1 GHz)
 - MS2651B
 - ≤ -110 dBm (1 MHz to 1 GHz)
 - ≤ -110 dBm + f [GHz] dB (>1 GHz)
 - MS2663B/2663C
 - ≤ -115 dBm (1 MHz to 1 GHz)
 - ≤ -115 dBm + 1.5 f [GHz] dB (1 to 3.1 GHz, Band 0)
 - ≤ -115 dBm + 0.5 f [GHz] dB (2.92 to 8.1 GHz, Band 1)
 - MS2653B
 - ≤ -110 dBm (1 MHz to 1 GHz)
 - ≤ -110 dBm + f [GHz] dB (1 to 3.1 GHz, Band 0)
 - ≤ -110 dBm + 0.5 f [GHz] dB (2.92 to 8.1 GHz, Band 1)

(2) Test instruments

- 50 Ω terminator: MP752A

(3) Setup

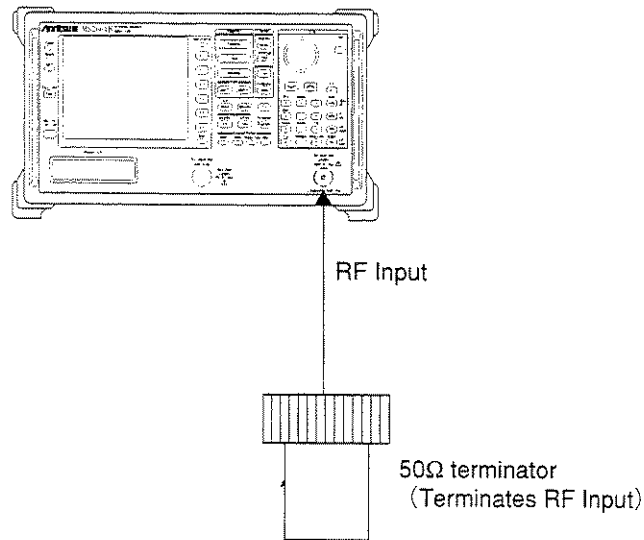

Average Noise Level Test

(4) Procedure

Step	Procedure
1	Press the spectrum analyzer [Preset] key.
2	Operate All Cal.
3	Terminate the RF Input with a 50 Ω terminator.
4	Set the spectrum analyzer as shown below: Start Freq 1 MHz Stop Freq 1 GHz Reference Level -40 dBm Attenuator 0 dB RBW 30 kHz VBW 3 kHz Detection Sample
5	Press the [Single] key to execute a single sweep.
6	Press the [\rightarrow CF] key to set the frequency at the peak level of the spectrum to the center frequency.
7	Press the [Shift] key and then the [Single] key to execute a continuous sweep.
8	Set the spectrum analyzer as shown below : (Time Domain) Span 0 Hz Reference Level -100 dBm RBW 1 kHz VBW 1 Hz
9	Press [Time], Storage, Average and Average Count keys in order and set the average count to 16.
10	Press the Continue key to start the averaging, and wait until the 16-time averaging sweep is completed.
11	Press the [Peak Search] key to execute peak search. At this point, read the level value at the marker.
12	Confirm that the marker reading is less than the specification, shown in the table on the next page.

Step	Procedure
------	-----------

MS2651B/2661B/2661C setting		Average noise level	
START FREQ	STOP FREQ	Marker readout	MS2651B/2661B/2661C specification
1 MHz	1 GHz		-110 dBm/-115 dBm
1 GHz	2 GHz		-109 to -108 dBm/ -114 to -113 dBm

MS2653B/2663B/2663C setting		Average noise level	
START FREQ	STOP FREQ	Marker readout	MS2653B/2663B/2663C specification
1 MHz	1 GHz		-115 dBm/-110 dBm
1 GHz	2 GHz		-113.5 to -112 dBm -118.5 to -107 dBm
4 MHz	6 GHz		-113 to -112 dBm -118 to -107 dBm
7 GHz	8 GHz		-111.5 to -111 dBm -106.5 to -106 dBm

- 13** Repeat steps 4 to 12 while setting Start/Stop Freq from the below table so that the average noise level can be obtained.

Second harmonic distortion

Even if a signal without harmonic distortion is input to a spectrum analyzer, the higher harmonics are generated by the analyzer input-mixer non-linearity and are displayed on the screen.

The second harmonic level is the highest harmonic displayed on the MS2650/MS2660B/C series spectrum analyzer. The main point of the test is to apply a signal (with a distortion that is lower than the spectrum analyzer internal harmonic distortion [at least 20 dB below]) to the spectrum analyzer and measure the level difference between the fundamental wave and the second harmonic. If a low-distortion signal source cannot be obtained, apply a low-distortion signal to the spectrum analyzer after passing the signal through a low-pass filter (LPF).

(1) Specifications

- Second harmonic distortion:
 - MS2661B/2661C
 - At mixer input level -30 dBm:
 - ≤-60 dBc (input frequency 10 to 200 MHz)
 - ≤-75 dBc (input frequency 200 to 1500 MHz)
 - ≤-80 dBc (input frequency 800 to 1000 MHz)
 - MS2651B
 - At mixer input level -30 dBm:
 - ≤-55 dBc (input frequency 10 to 100 MHz)
 - ≤-60 dBc (input frequency 100 to 1500 MHz)
 - MS2663B/2663C
 - At mixer input level -30 dBm:
 - ≤-60 dBc (10 to 200 MHz, Band 0)
 - ≤-75 dBc (0.2 to 1.3 GHz, Band 0)
 - ≤-70 dBc (1.3 to 1.55 GHz, Band 0)
 - ≤-80 dBc (0.8 to 1 GHz, Band 0)
 - At mixer input level -20 dBm:
 - ≤-100 dBc (1.46 to 4.05 GHz, Band 1-/1+)
 - MS2653B
 - At mixer input level -30 dBm:
 - ≤-55 dBc (10 to 100 MHz)
 - ≤-60 dBc (0.1 to 1.55 GHz)
 - At mixer input level -20 dBm:
 - ≤-100 dBc (1.46 to 4.05 GHz, Band 1-/1+)

(2) Test instruments

- Signal generator: MG3633A
- LPF: With attenuation of 70 dB or more at twice the fundamental frequencies

(3) Setup

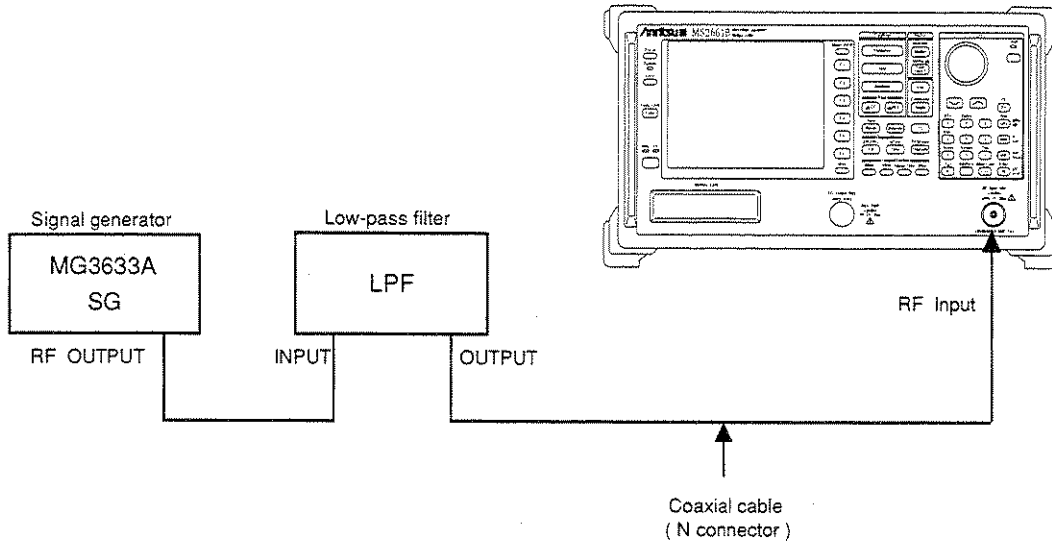

Second Harmonic Distortion Test

(4) Procedure

Step	Procedure
1	Press the [Preset] key.
2	Operate All Cal.
3	Set the LPF cut-off frequency to approx. 12.8 MHz.
4	Set the SG output frequency to 10 MHz and the output level to -30 dBm.
5	Set the spectrum analyzer as shown below: Center Freq 10 MHz Span 10 kHz Reference Level -30 dBm Attenuator 0 dB
6	Adjust the SG output level so that peak of the spectrum waveform is at the REF LEVEL (the top horizontal line of the screen).

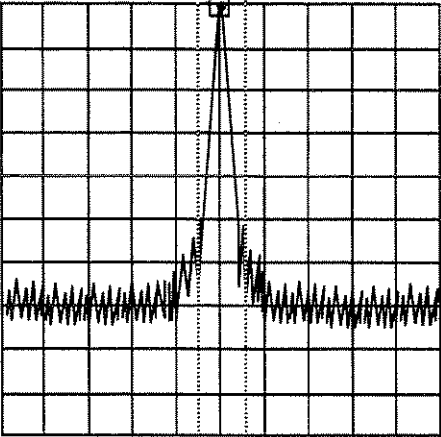
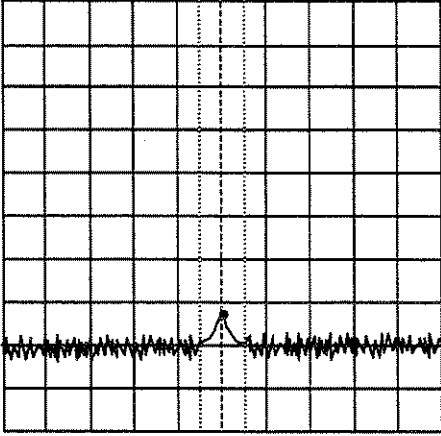
Step	Procedure	
7	Move the marker to the peak of the spectrum waveform and make the marker the Δ marker.	 <p>The image shows a spectrum analyzer screen with a grid. A signal waveform is visible, with a prominent peak. A vertical dashed line (marker) is positioned at the peak, and a small square symbol is placed at the top of this line, indicating it is the active marker.</p>
8	<p>Set the center frequency to twice the fundamental wave frequency to display the second harmonic on the screen.</p> <p>The Δ marker reading indicates the level difference between the fundamental wave and the second harmonic.</p> <p>If the level difference is 80 dB or more, set the REF LEVEL to -50 dBm. Confirm that the ATT set value is 0 dB.</p>	 <p>The image shows the same spectrum analyzer screen as in step 7, but the center frequency has been shifted to twice the fundamental frequency. A smaller peak is now visible, and the vertical dashed line (marker) is positioned at this second harmonic peak.</p>
9	Set the LPF cut-off frequency to approx. 1.2 GHz.	
10	<p>Set the SG as follows:</p> <p>OUTPUT FREQ 1 GHz</p> <p>OUTPUT LEVEL -30 dBm</p>	
11	<p>Set the spectrum analyzer as follows:</p> <p>Center Freq 1 GHz</p> <p>Span 10 kHz</p> <p>Reference Level -30 dBm</p> <p>Attenuator 0 dB</p>	
12	Repeats steps 6 to 8.	

Resolution bandwidth (RBW) switching uncertainty

When the resolution bandwidth (RBW) is switched, its level error at the peak point is measured.

(1) Specifications

- Resolution bandwidth switching uncertainty: ± 0.3 dB (RBW=1 kHz to 1 MHz)
(referenced to RBW:3 kHz)
 - ± 0.4 dB (RBW=5 MHz for MS2651B/2661B/2653B/2663B)
 - ± 0.4 dB (RBW=3 MHz for MS2661C/2663C)

(2) Setup

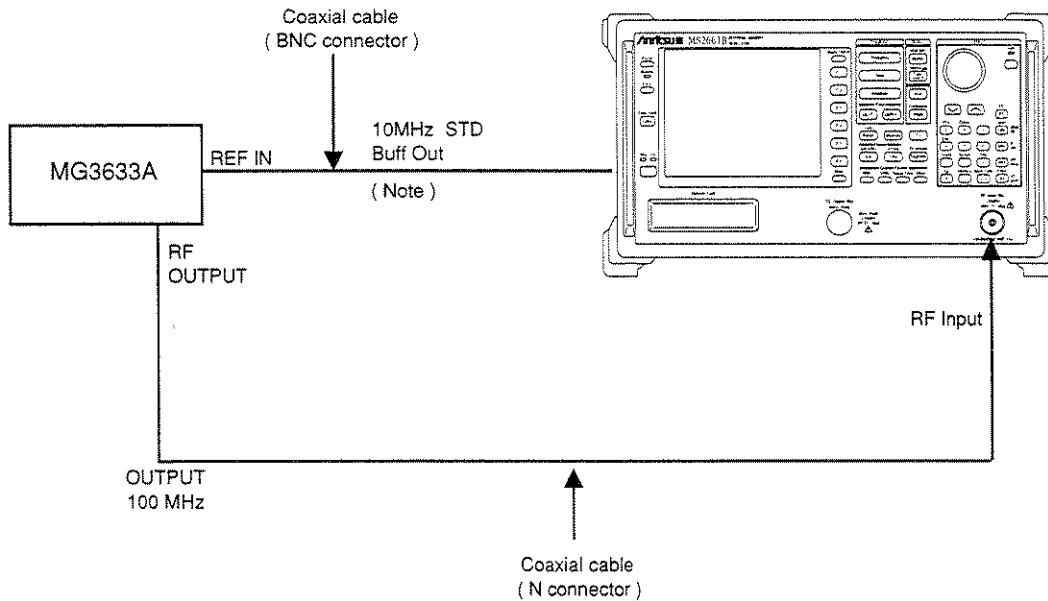

Resolution Bandwidth Switching Error Test

- (Note) If there is no buffer output for the reference oscillator (Option 01) on the rear panel, input a reference signal from an external 10 MHz frequency standard to the main body and signal generator.

(4) Procedure

Step	Procedure
1	Press the spectrum analyzer [Preset] key.
2	Operate All Cal.
3	Set the signal generator MG3633A as shown below. OUTPUT FREQ 100 MHz OUTPUT LEVEL 0 dBm
4	Set the spectrum analyzer as shown below. Center Freq 100 MHz Span 15 kHz Reference Level 0 dBm RBW 3 kHz
5	Press the [\rightarrow CF] key to move the signal spectrum peak to the center.
6	Press [Marker] key in that order to set the marker to Δ marker.
7	Set RBW and SPAN as shown in the table on the next page and measure the level deviation (error) of each RBW by following steps 8 and 9 below.
8	Press [Peak Search] key to conduct peak search and move the current marker to the peak point of the signal spectrum.
9	Read the Δ marker level value.

Resolution bandwidth (RBW) switching uncertainty

• MS2651B/2661B/2653B/2663B

MS2650/2660 series setting		Δ marker readout	Specification
RBW	SPAN		
1 kHz	5 kHz		± 0.3 dB
3 kHz	15 kHz	0.0 dB	Reference
10 kHz	50 kHz		± 0.3 dB
30 kHz	150 kHz		± 0.3 dB
100 kHz	500 kHz		± 0.3 dB
300 kHz	1.5 MHz		± 0.3 dB
1 MHz	5 MHz		± 0.3 dB
5 MHz	10 MHz		± 0.4 dB

• MS2661C/2663C

MS2650/2660 series setting		Δ marker readout	Specification
RBW	SPAN		
1 kHz	5 kHz		± 0.3 dB
3 kHz	15 kHz	0.0 dB	Reference
10 kHz	50 kHz		± 0.3 dB
30 kHz	150 kHz		± 0.3 dB
100 kHz	500 kHz		± 0.3 dB
300 kHz	1.5 MHz		± 0.3 dB
1 MHz	5 MHz		± 0.3 dB
3 MHz	10 MHz		± 0.4 dB

Input attenuator (RF ATT) switching uncertainty

At this point, measure the switching error when the amount of attenuation in the RF input section is switched. When the input attenuator is switched, IF-section step-amplifier gain is switched. To keep this step-amplifier gain constant, the reference level is switched according to the amount of input attenuator attenuation.

(1) Specifications

- Input attenuator switching error: ± 0.3 dB (at 0 to 50 dB, frequency 100 MHz and input ATT 10 dB)

(2) Test instruments

- Signal generator: MG3633A
- Attenuator: MN510C
- Power meter: ML4803A
- Power sensor: MA4601A

(3) Setup

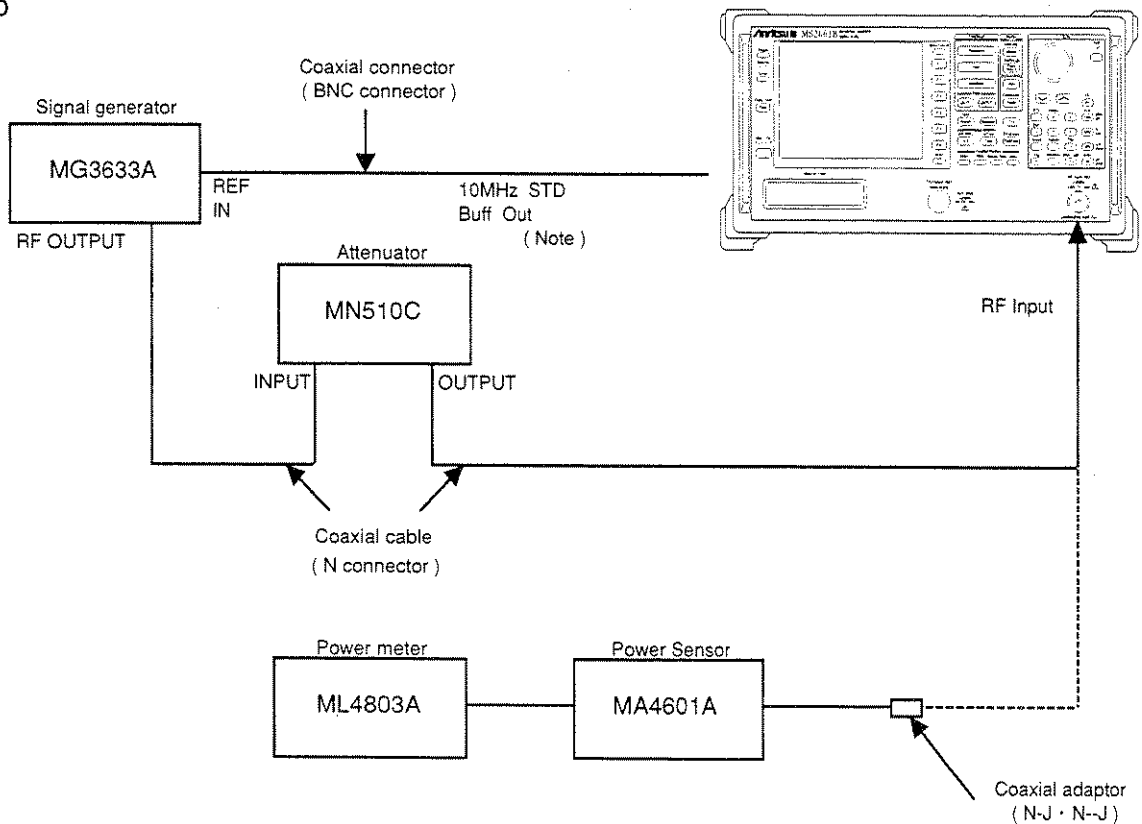

Input Attenuator Switching Error Test

(Note) If there is no buffer output for the reference oscillator (Option 01) on the rear panel, input a reference signal from an external 10 MHz frequency standard to the main body and signal generator.

(4) Procedure

Step	Procedure
1	Press the spectrum analyzer [Preset] key.
2	Operate All Cal.
3	Set the spectrum analyzer as shown below: Center Freq 100 MHz Span 200 kHz
4	Set the signal generator MG3633A as shown below: OUTPUT FREQ 100 MHz OUTPUT LEVEL -10 dBm
5	Set the amount of attenuation of the attenuator MN510C to 0 dB.
6	Connect the output of the attenuator MN510C to the power meter via coaxial cable.
7	Adjust the signal-generator output level so that the indicated value of the power meter is -10.0 dBm.
8	Connect the coaxial cable of the attenuator output to the spectrum analyzer RF Input.
9	Press the [\rightarrow CF] key.
10	Set the reference level to -10 dBm and attenuation to 50 dB.
11	Read the marker level.
12	Set Reference Level, RF ATT of this device and the external ATT as shown in the table on the next page, and read the level of each marker.
13	Find the error by the formula below: $\text{Error} = \text{marker readout} - \text{Reference Level} - \text{correction factor of attenuator}$
14	Find the deviation by the formula below: $\text{Deviation} = \text{Error} - \text{error when RF ATT at 10 dB}$ Confirm that the deviation is within ± 0.3 dB.

Spectrum analyzer setting		Attenuator setting	Correction factor of attenuator	Marker readout	Error	Deviation
REF LEVEL	RF ATT					
-10 dBm	50 dB	0 dB	dB	dBm	dB	dB
-20 dBm	40 dB	10 dB	dB	dBm	dB	dB
-30 dBm	30 dB	20 dB	dB	dBm	dB	dB
-40 dBm	20 dB	30 dB	dB	dBm	dB	dB
-50 dBm	10 dB	40 dB	dB	dBm	dB	0 dB (reference)
-60 dBm	0 dB	50 dB	dB	dBm	dB	dB

Sweep time and time span accuracy

(1) Specifications

- Sweep time accuracy: $\pm 15\%$ (20 msec to 100 sec)
 $\pm 45\%$ (110 sec to 1000 sec)
- Time span accuracy: $\pm 1\%$

(2) Test instruments

- Signal generator: MG3633A
69269A

(3) Setup

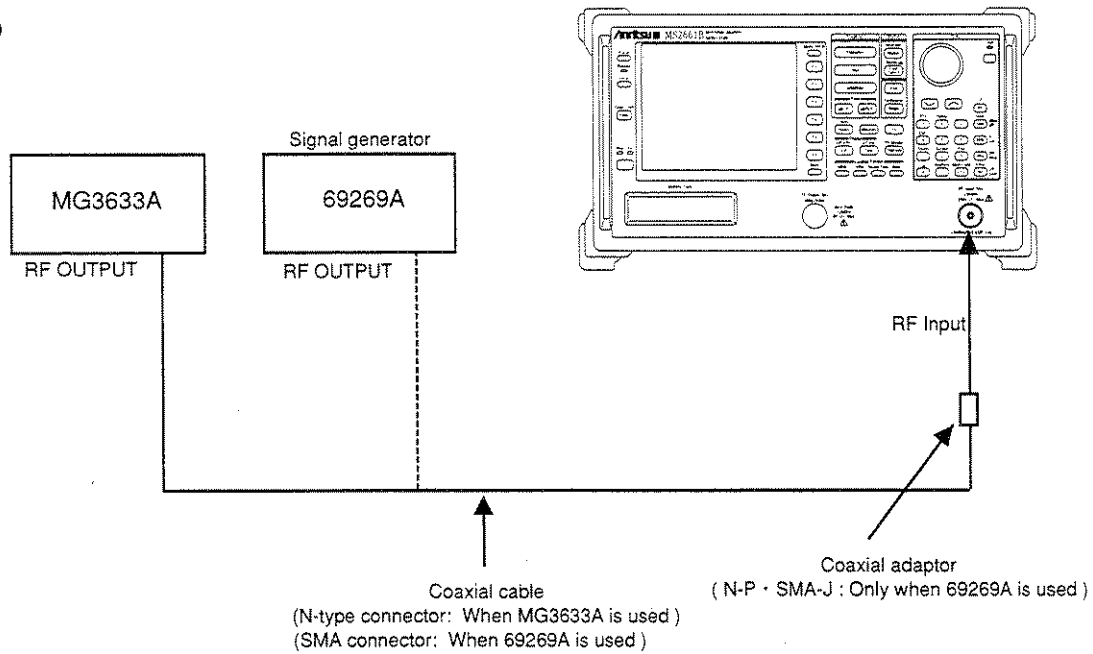

Sweep Time and Time Span Accuracy

(4) Procedure

(a) Sweep Time

Step	Procedure
1	Press the spectrum analyzer [Preset] key.
2	Operate All Cal.
3	Connect the MG3633A signal generator with the spectrum analyzer as shown in the setup diagram.
4	Set the spectrum analyzer as shown below: CENTER FREQ 100 MHz SPAN 50 kHz SWP TIME 50 msec RBW 1 MHz VBW 1 MHz
5	Set the MG3633A as shown below: OUTPUT FREQ 100 MHz OUTPUT LEVEL -16 dBm MODULATION AM (INT) 90 % MODULATION FREQ 400 Hz
6	Press the [→ RLV] key.
7	Set the scale to Linear.
8	Press the [Single] key, then wait until a single sweep execution is completed.
9	Set the marker zone width to 5 Hz (Zone Width=5 Hz).
10	Move the marker to the left of the screen using the knob and set the zone marker on the left most peak of the sine wave.
11	Setting the marker mode to Δ (delta), move the current marker to the right using the knob. Then set the zone marker to the 18th peak from the left most sine wave peak on the screen.
12	Read the frequency difference of the Δ marker, which corresponds to 90 % of the Sweep Time. Obtain the SWP TIME by the following equation.

$$\text{SWP TIME (measured)} = \text{Setting SWP TIME} \times \frac{\Delta \text{ marker readout}}{50000 \text{ (Hz)}}$$

Step	Procedure
------	-----------

13 Measure at each setting shown in the table below according to steps 8 to 12.

Spectrum analyzer Setting SWP TIME	Signal Generator AM modulation frequency	SWP TIME (measured)	Specification * min/max
50 msec	400 Hz		38.25 msec/51.75 msec
200 msec	100 Hz		153 msec/207 msec
2 sec	10 Hz		1.53 sec/2.07 sec
20 sec	1 Hz		15.3 sec/20.7 sec
200 sec	0.1 Hz		99 sec/261 sec

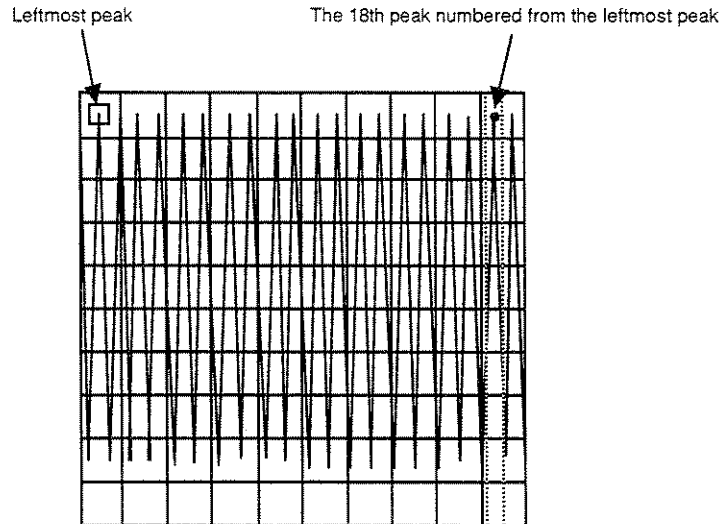

* = Setting SWT TIME × (18/20) × accuracy

(b) Time span

Step	Procedure
1	Press the spectrum analyzer [Preset] key.
2	Operate All Cal.
3	Connect the MG3633A signal generator with the spectrum analyzer shown in the setup diagram.
4	Set the spectrum analyzer as shown below: CENTER FREQ 100 MHz SPAN 0 MHz SWEEP TIME 20 msec RBW 1 MHz VBW 1 MHz
5	Set the MG3633A as shown below: OUTPUT FREQ 100 MHz OUTPUT LEVEL -16 dBm MODULATION AM (INT) 90 % MODULATION FREQ 1 kHz
6	Press the [→RLV] key.
7	Set the scale to Linear.
8	Press the [Single] key, then wait until a single sweep execution is completed.
9	Move the marker to the left of the screen using the knob and set the marker on the left most peak of the sine wave.
10	Setting the marker mode to Δ (delta), move the current marker to the right using the knob. Then set the marker to the 18th peak from the left most sine wave peak on the screen.
11	Read the time difference of the Δ marker, which corresponds to 90 % of the Time Span.
12	Measure at each setting shown in the table below according to step 4 to 11.

Spectrum analyzer time span	Signal Generator AM modulation frequency	Time Span (measured)	Specification * min/max
20 msec	1 kHz		17.82 msec/18.18 msec
200 msec	100 Hz		178.2 msec/181.8 msec
2 sec	10 Hz		1.782 sec/1.818 sec
20 sec	1 Hz		17.82 sec/18.18 sec
200 sec	0.1 Hz		178.2 sec/181.8 sec

* = Setting Time Span × (18/20) × accuracy

Tracking generator (TG) output level accuracy

The output level of the Tracking Generator (TG, Option 20) can be easily tested by inputting the TG output signal to the RF Input connector of the Spectrum analyzer.

Here, an accurate method to test the TG output level by using a power meter, is described below.

(1) Specifications

Output level range:	0 to -60 dBm
Output level accuracy:	$\leq \pm 1.0$ dB (at frequency 100 MHz, output level 0 dBm)
Output level flatness:	$\leq \pm 1.5$ dB (at output level 0 dBm, referenced to 100 MHz)
Output level linearity:	$\leq \pm 1.0$ dB (output level 0 to -30 dBm) $\leq \pm 2.0$ dB (output level -30 to -60 dBm) (referenced to 0 dBm)

(2) Test instrument

- Power meter: ML4803A
- Power sensor: MA4601A, MA4602A

(3) Setup

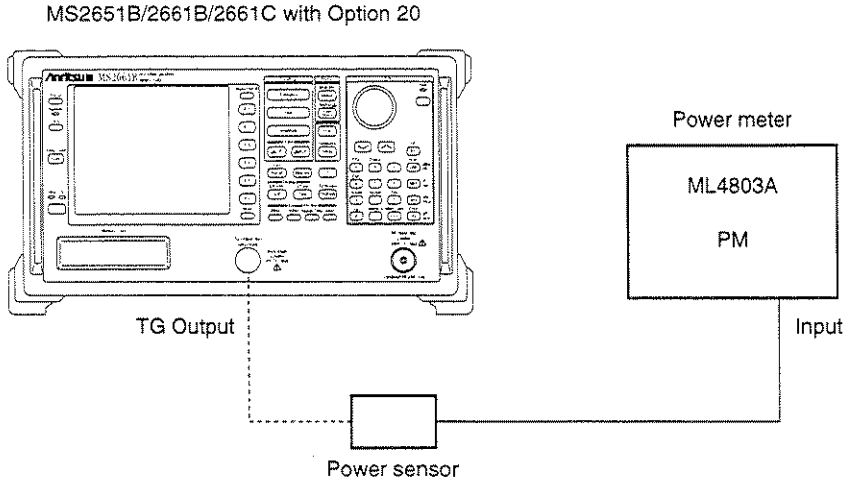

TG Output Level Accuracy Test

(4) Procedure

(a) Calibrating ML4803A Power Meter

Step	Procedure
1	Warm-up the ML4803A, then zero-adjust the ML4803A. (Note: Don't connect anything to the power sensor.)
2	Connect the power sensor to the CAL OUTPUT of the ML4803A. Press the [ON] key. After conforming the measured value to be stabilized, press the [ADJ] key for calibration.

(b) Measuring TG output level accuracy

Step	Procedure
1	Press the [Preset] key.
2	Connect the power sensor to the TG Output.
3	Set the spectrum analyzer as shown below: Center Freq ----- 100 MHz Span ----- 10 MHz
4	Set the TG output level to 0 dBm, and ON.
5	Measure the TG output level with the power meter.
6	Changing the Center Freq of the spectrum analyzer as shown in the table on the next page, repeat the steps 3 to 5 above.
7	Changing the output level of the spectrum analyzer as shown in the table on the next page, repeat the steps 3 to 6 above.

TG Output Level Accuracy Test

Output level (dBm)	Frequency (Hz)							
	100k	1M	10M	50M	100M	1G	2G	3G
0								
-1 to -9								
-10								
-20								
-30								
-40								
-50								

Service

If the instrument is damaged or does not operate as specified, contact your nearest Anritsu dealer or business office for repair. When you request repair, provide the following information.

- (a) Model name and serial number on rear panel
- (b) Fault description
- (c) Name of a personnel-in-charge and address for contact when fault confirmed or at a completion of repair

SECTION 7

STORAGE AND TRANSPORTATION

This section describes the long-term storage, repacking and transportation of the MS2650/MS2660B/C series as well as the regular care procedures and the timing.

TABLE OF CONTENTS

Cleaning Cabinet	7-3
Storage Precautions	7-4
Precautions before storage	7-4
Recommended storage precautions	7-4
Repacking and Transportation	7-5
Repacking	7-5
Transportation	7-5

SECTION 7 STORAGE AND TRANSPORTATION

Cleaning Cabinet

Always turn the spectrum analyzer POWER switch OFF and disconnect the power plug from the AC power inlet before cleaning the cabinet. To clean the external cabinet:

- Use a soft, dry cloth for wiping off.
- Use a cloth moistened with diluted neutral cleaning liquid if the instrument is very dirty or before long-term storage.

After insuring that the cabinet has been thoroughly dried, use a soft, dry cloth for wiping off.

- If loose screws are found, tighten them with the appropriate tools.

CAUTION

Never use benzene, thinner, or alcohol to clean the external cabinet; it may damage the coating, or cause deformation or discoloration.

Storage Precautions

This paragraph describes the precautions to take for long-term storage of the MS2650/MS2660B/C series SPECTRUM ANALYZER.

Precautions before storage

- (1) Before storage, wipe dust, finger-marks, and other dirt off the spectrum analyzer.
- (2) Avoid storing the spectrum analyzer where:
 - 1) It may be exposed to direct sunlight or high dust levels.
 - 2) It may be exposed to high humidity.
 - 3) It may be exposed to active gases.
 - 4) It may be exposed to extreme temperatures ($>40\text{ }^{\circ}\text{C}$ or $>70\text{ }^{\circ}\text{C}$) or high humidity ($\geq 90\%$).

Recommended storage precautions

The recommended storage conditions are as follows:

- Temperature 0 to 30 $^{\circ}\text{C}$
- Humidity 40 % to 80 %
- Stable temperature and humidity over 24-hour period

Repacking and Transportation

The following precautions should be taken if the MS2650/MS2660B/C series SPECTRUM ANALYZER must be returned to Anritsu Corporation for servicing.

Repacking

Use the original packing materials. If the spectrum analyzer is packed in other materials, observe the following packing procedure:

- (1) Wrap the spectrum analyzer in a plastic sheet or similar material.
- (2) Use a cardboard, wooden box, or aluminum case which allows shock-absorbent material to be inserted on all sides of the equipment.
- (3) Use enough shock-absorbent material to protect the spectrum analyzer from shock during transportation and to prevent it from moving in the container.
- (4) Secure the container with packing straps, adhesive tape or bands.

Transportation

Do not subject the spectrum analyzer to severe vibration during transport. It should be transported under the storage conditions recommended before.

SECTION 7 STORAGE AND TRANSPORTATION

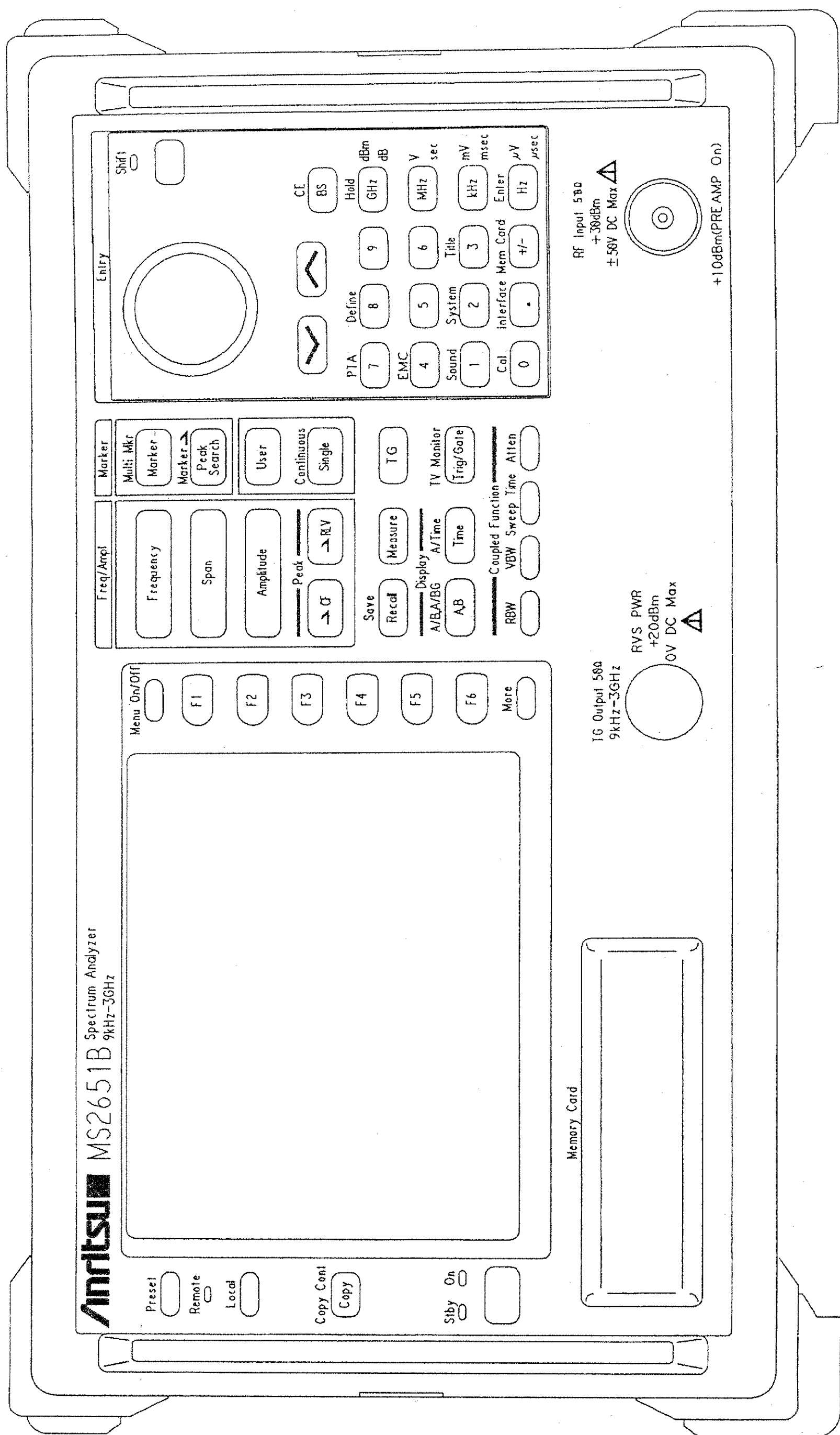
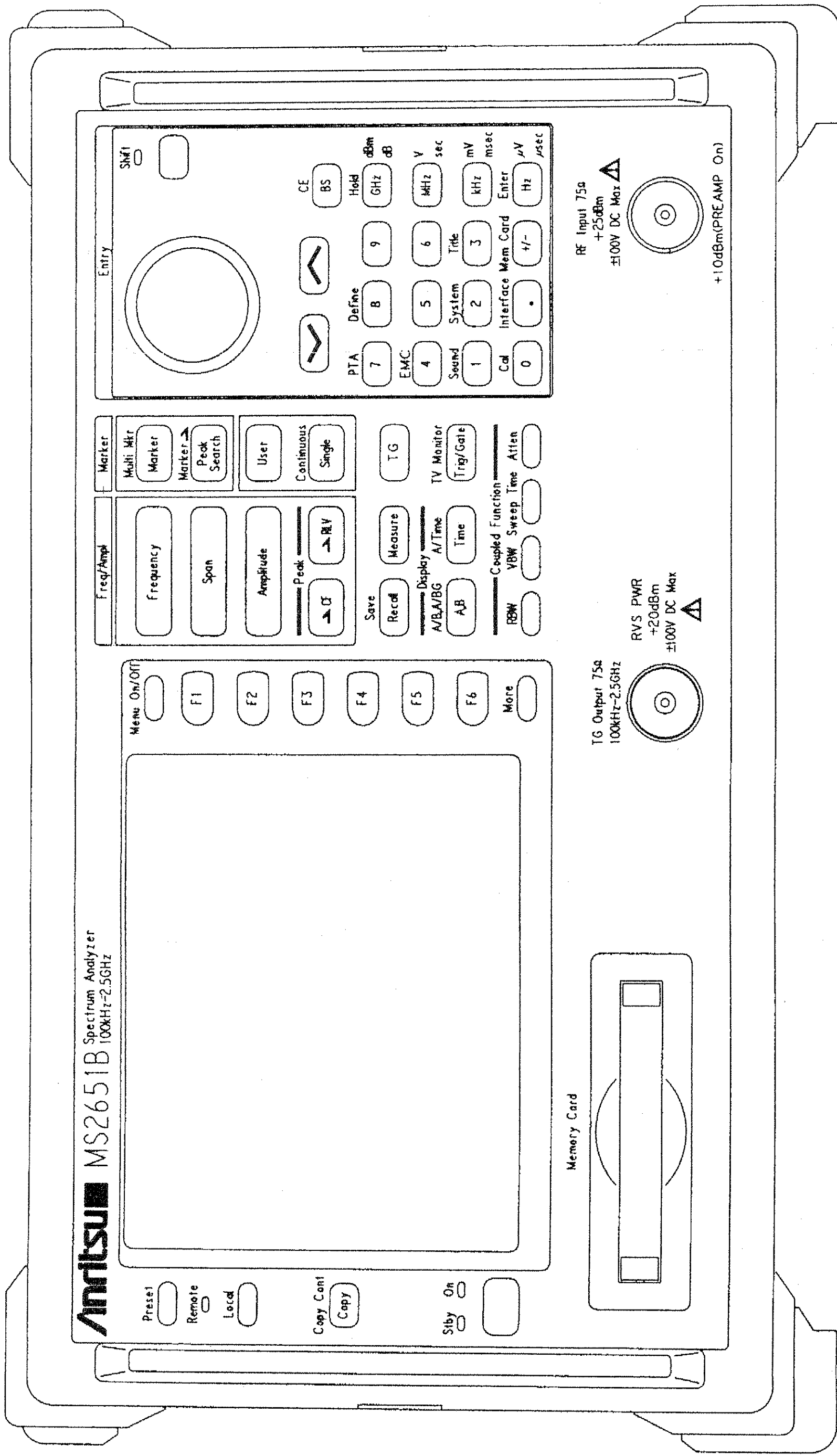

Fig. A-1 MS2651B Front Panel



Anritsu MS2651B Spectrum Analyzer
100kHz-2.5GHz

Presei
Remote
Local
Copy Cont
Copy
Siby On
On

Menu On/Off
F1
F2
F3
F4
F5
F6
More

Freq/Ampl
Frequency
Span
Amplitude
Peak
→ CF
← RV

Marker
Multi Mkr
Marker
Marker →
Peak Search
User
Continuous
Single

Save
Recall
Measure
Display A/Time
A/B
Time
Coupled Function
RBW
VBW
Sweep Time
Atten

TG
TV Monitor
Trig/Gate

Entry

SMF1

CE
BS
Hold
GHz
dBm
dB

Define
8
9
MHz
V
sec

EMC
4
5
MHz
kHz
mV
msec

System
2
3
kHz
mV
msec

Sound
1
Title
3
kHz
mV
msec

Cal
0
Interface Mem Card
Enter
Hz
μV
μsec

Memory Card

TG Output 75Ω
100kHz-2.5GHz

RVS PWR
+20dBm
±100V DC Max

RF Input 75Ω
+25dBm
±100V DC Max

+10dBm(PREAMP On)

Fig. A-2 MS2651B (with Opt.22, 23) Front Panel

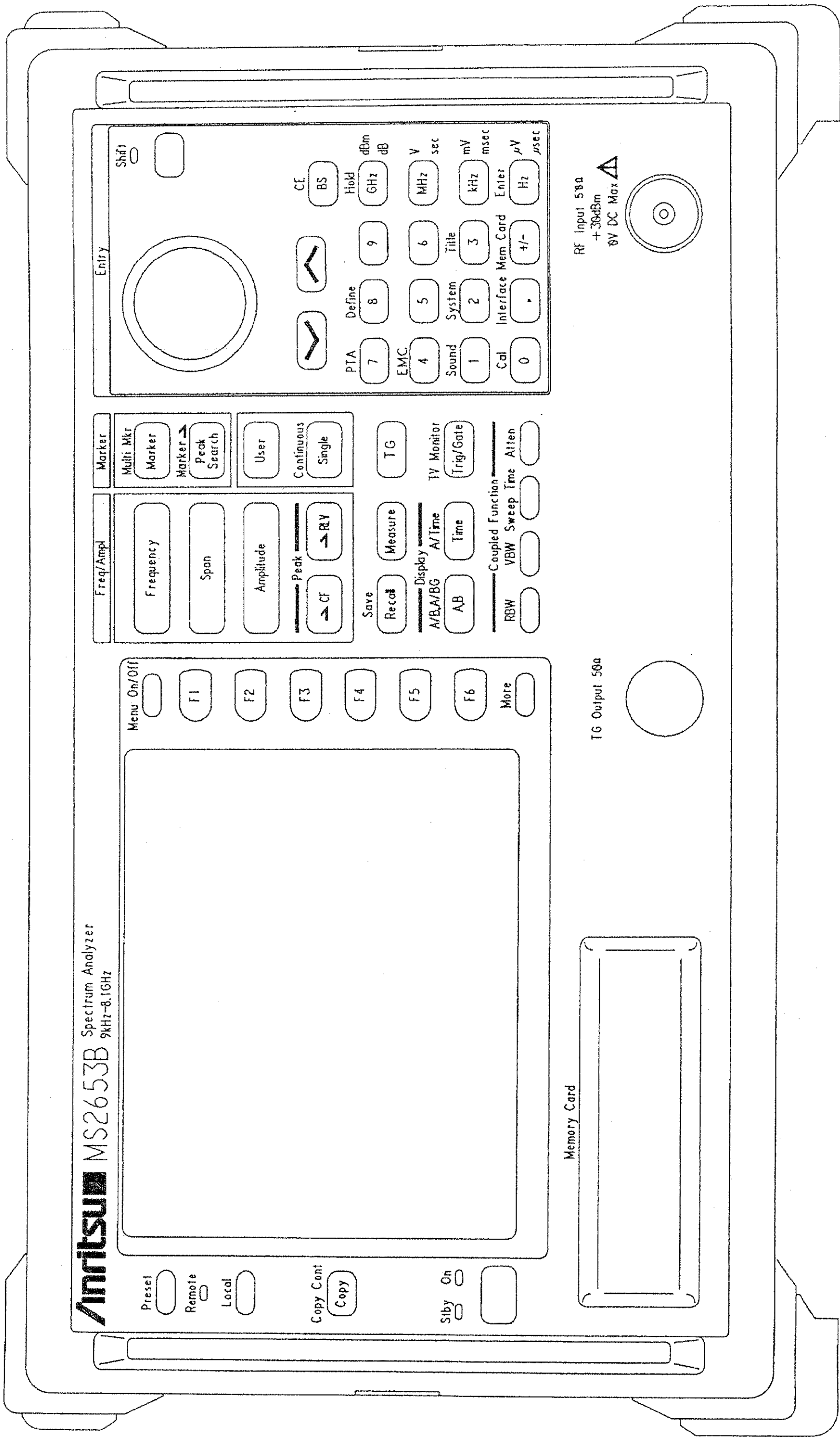

Fig. A-3 MS2653B Front Panel

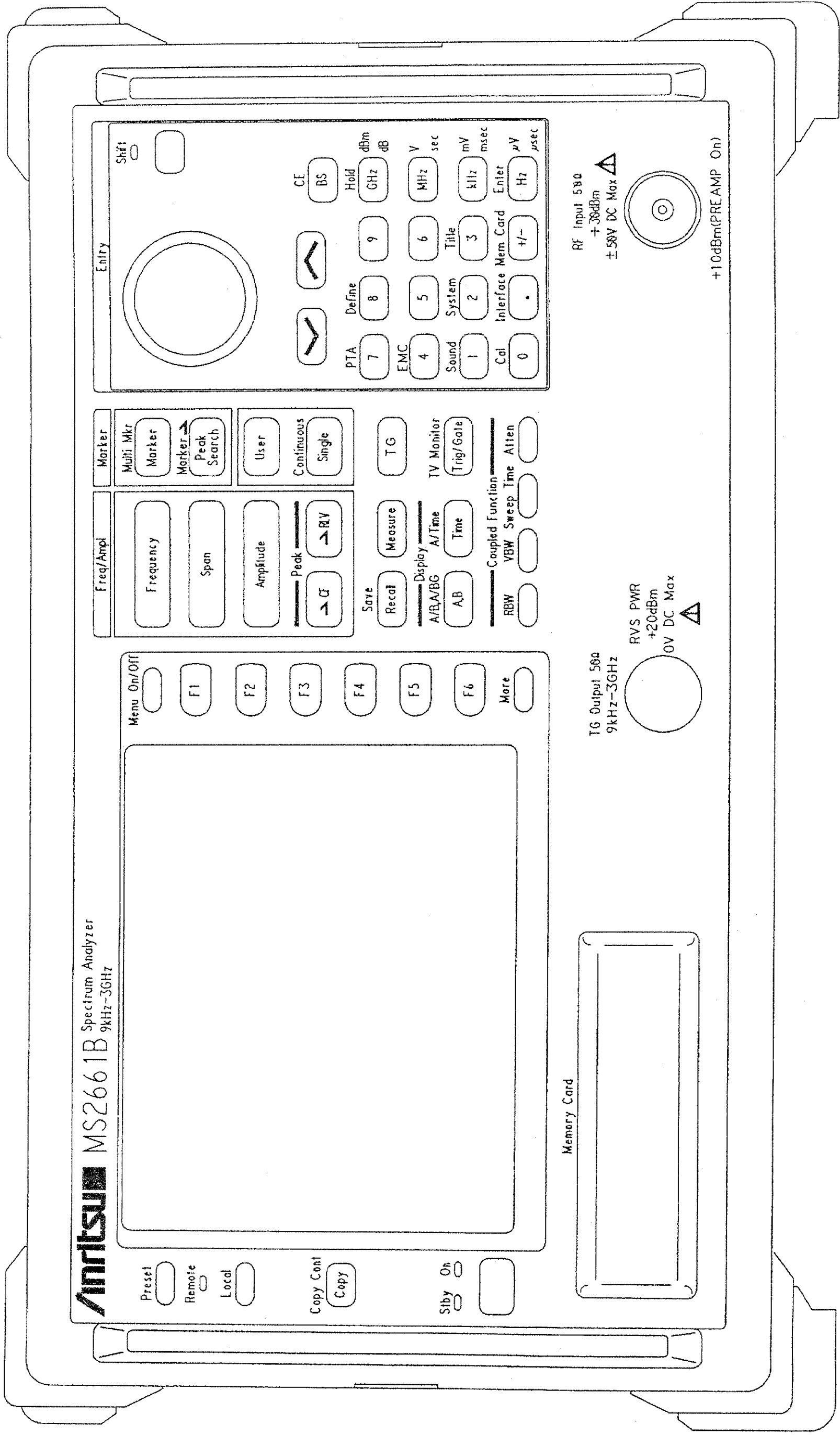

Fig. A-4 MS2661B Front Panel

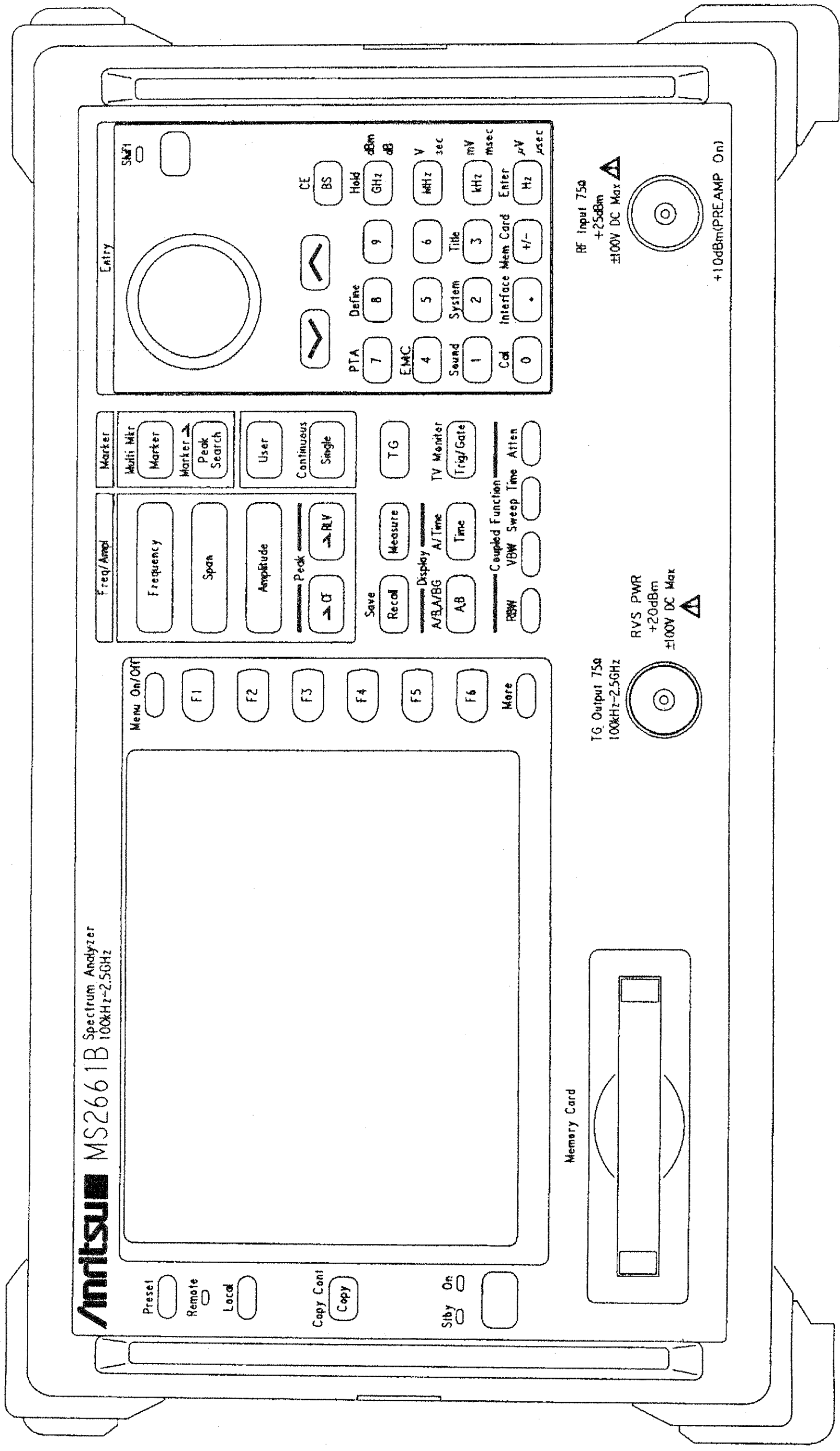

Fig. A-5 MS2661B (with Opt.22, 23) Front Panel

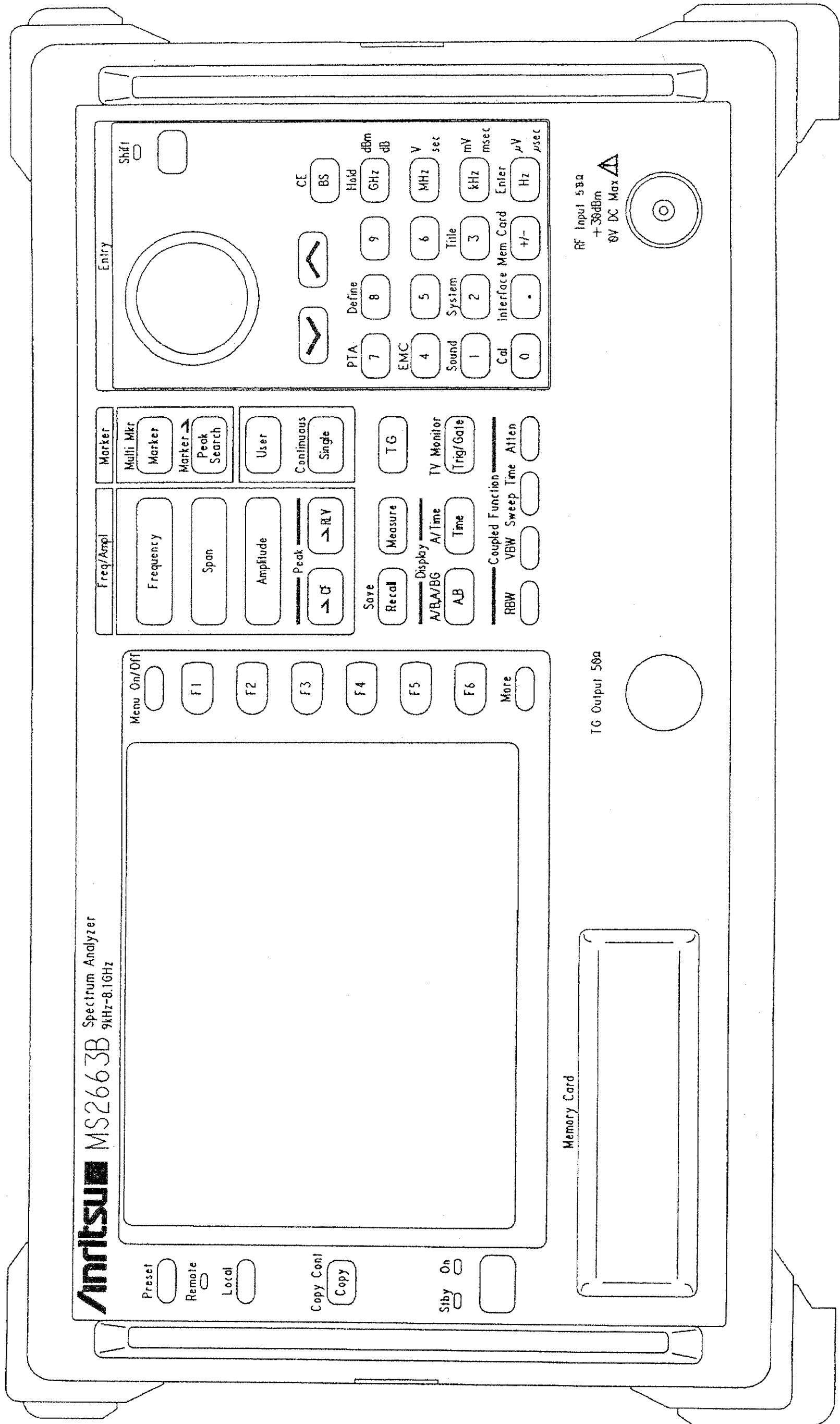
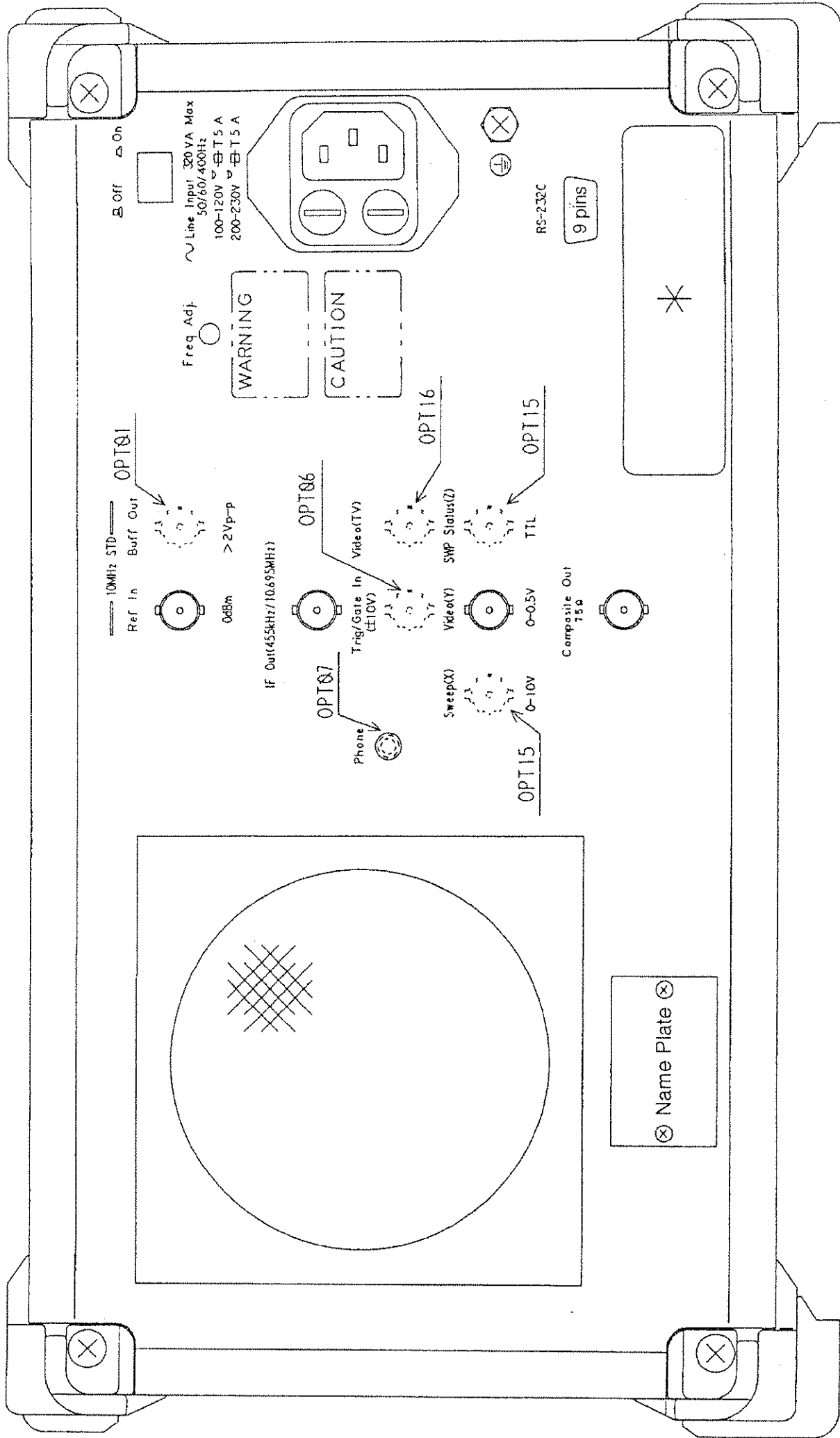

Fig. A-6 MS2663B Front Panel



*; OPT10

*; Standard

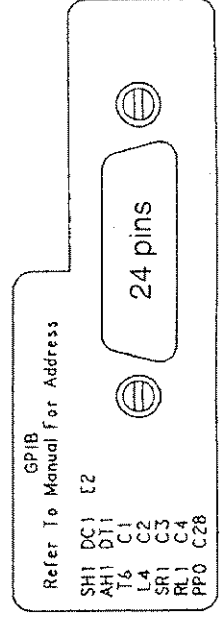
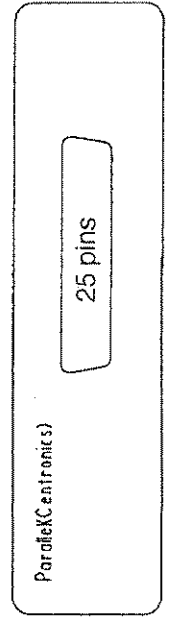

Fig. A-7 MS2651B/2661B/2653B/2663B Rear Panel

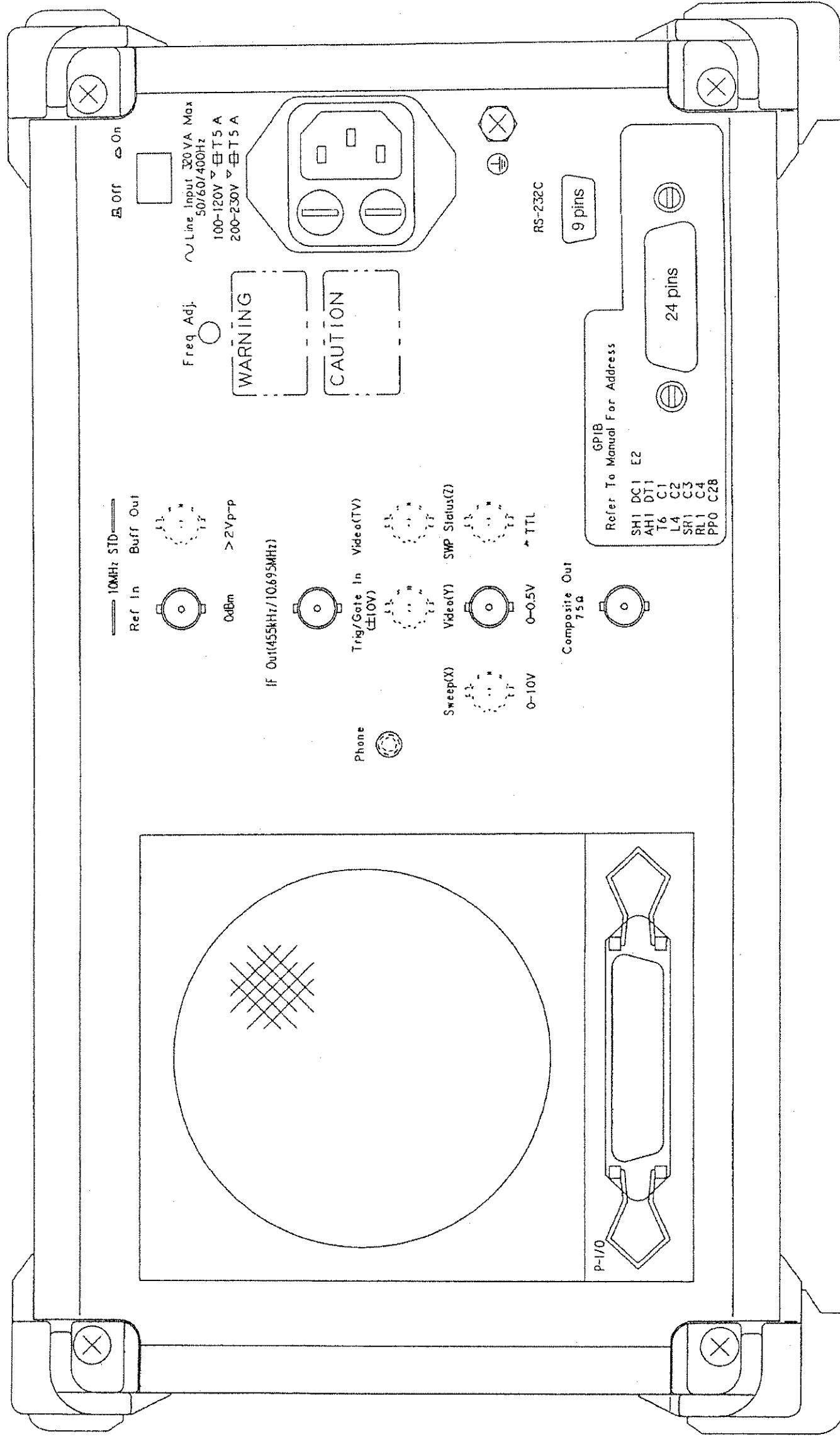

Fig. A-8 MS2651B/2661B/2653B/2663B
(with Opt.14) Rear Panel

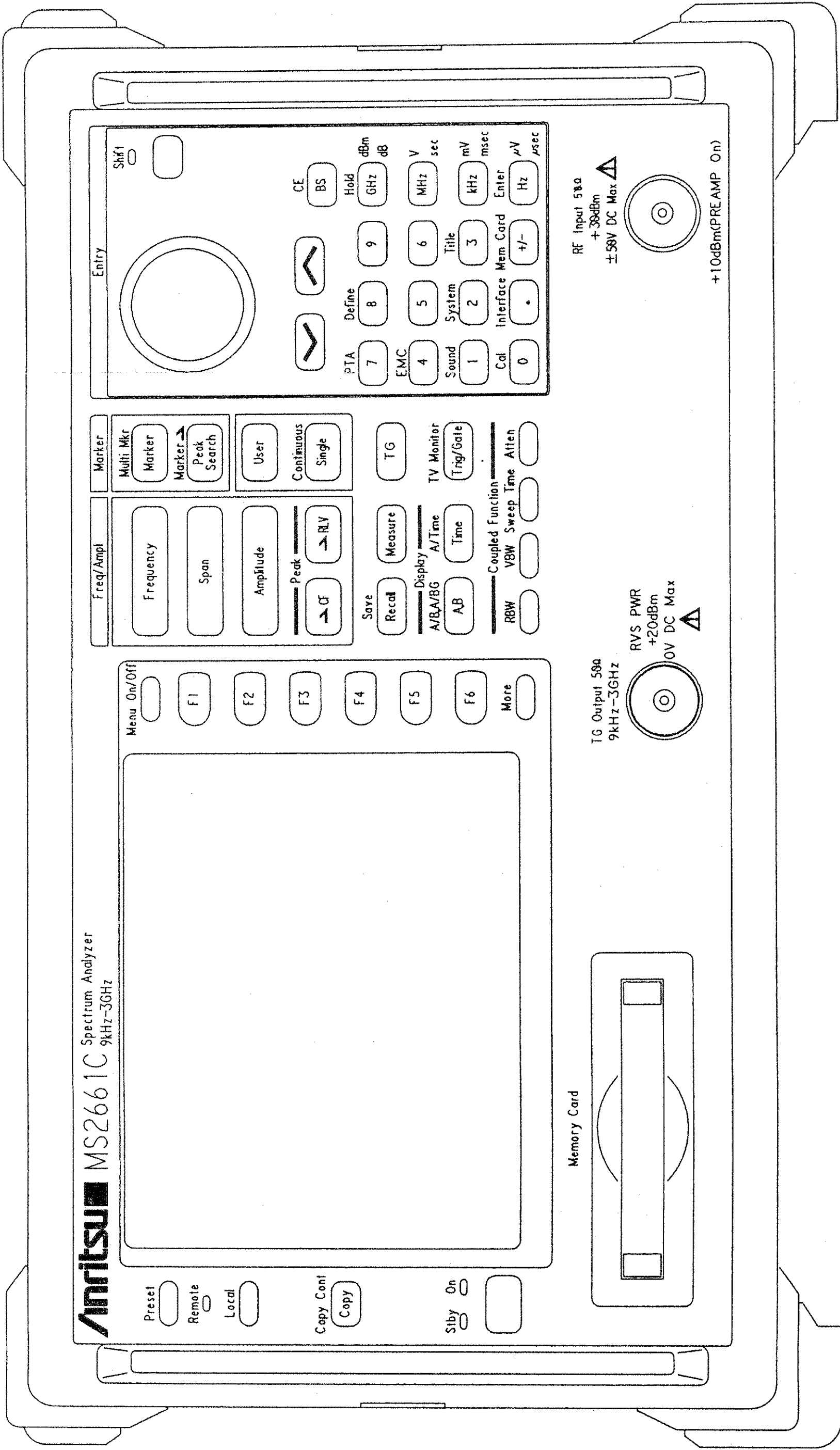

Fig. A-9 MS2661C Front Panel

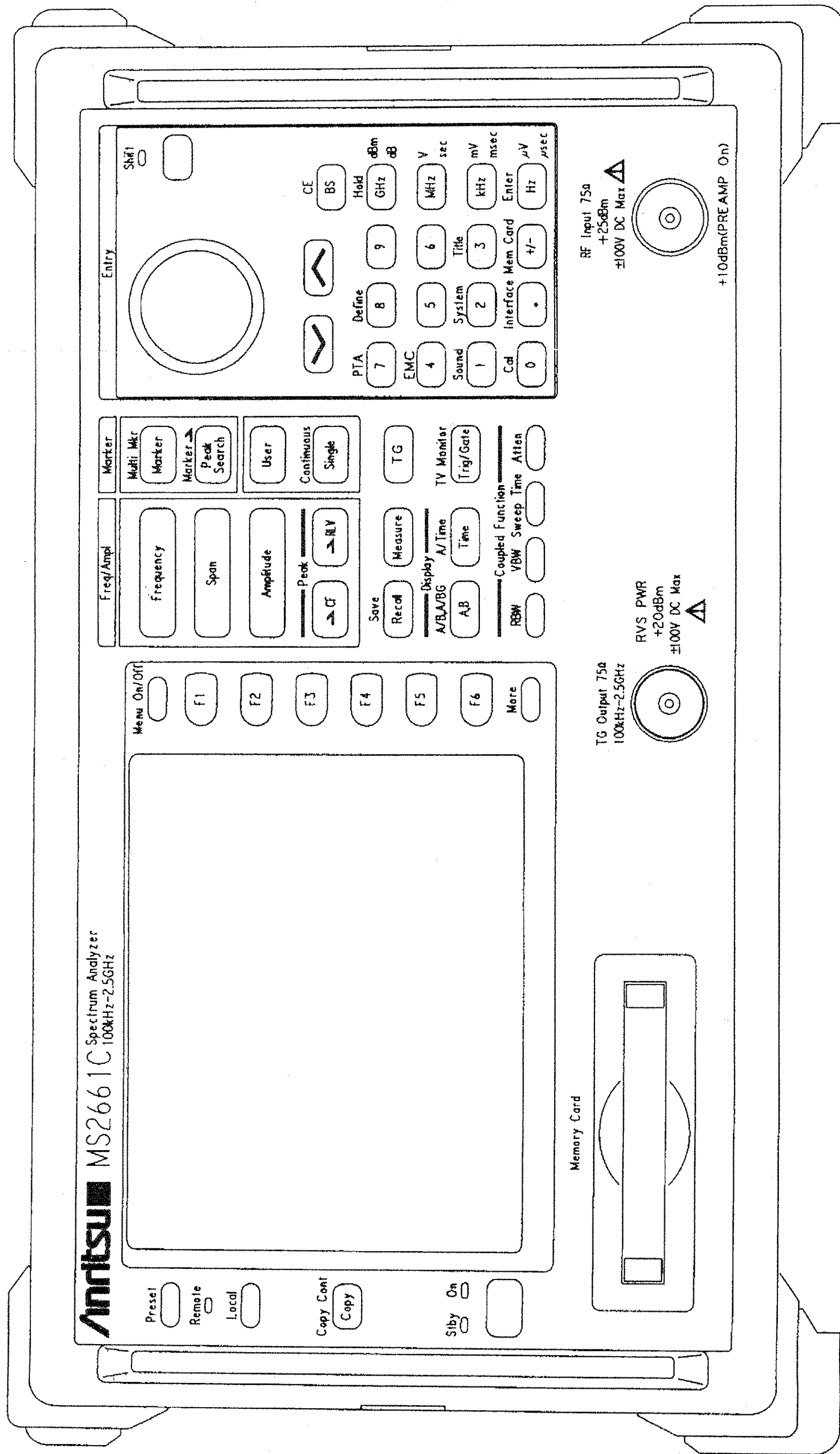

Fig. A-10 MS2661C (with Opt.22, 23) Front Panel

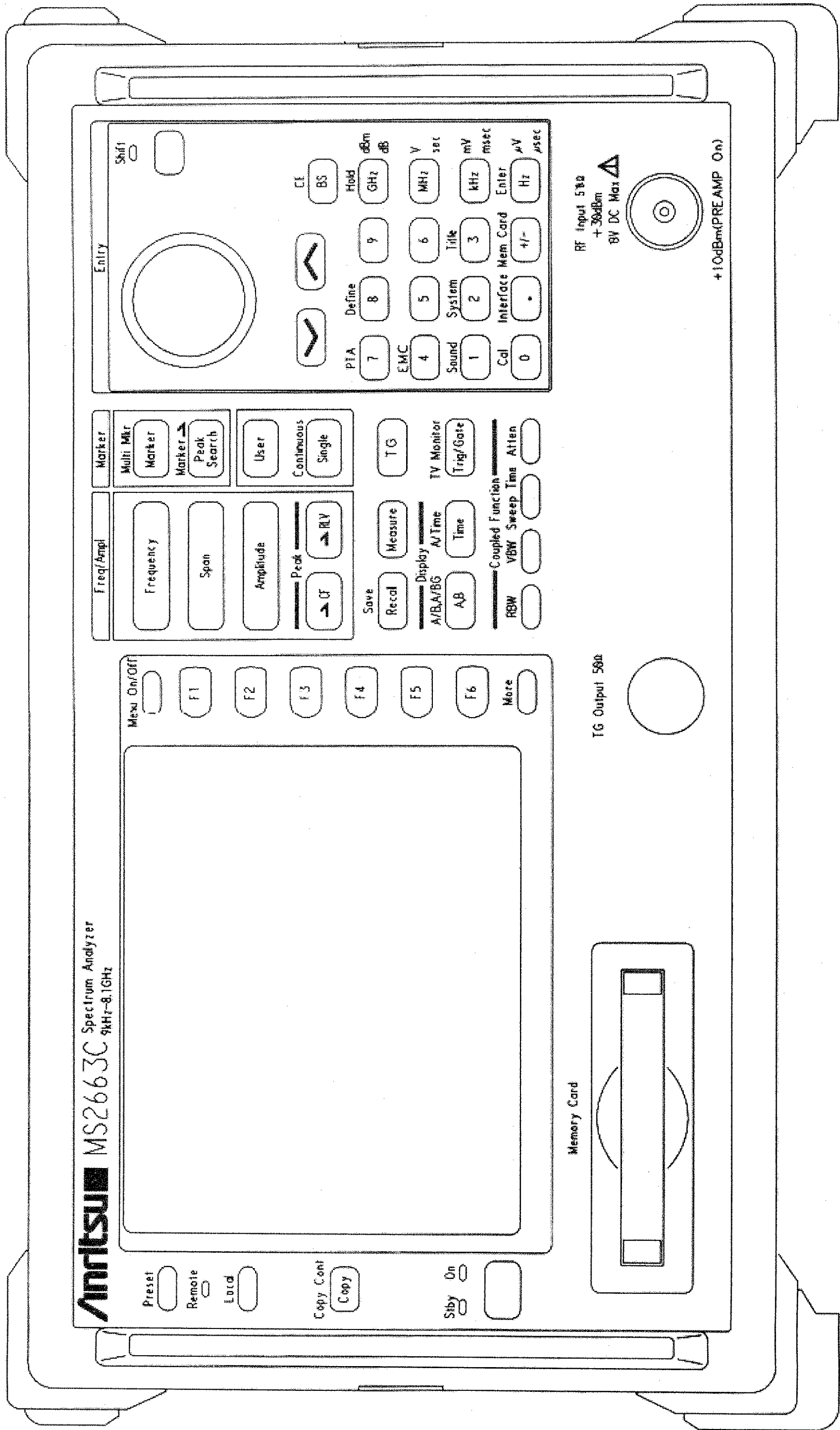
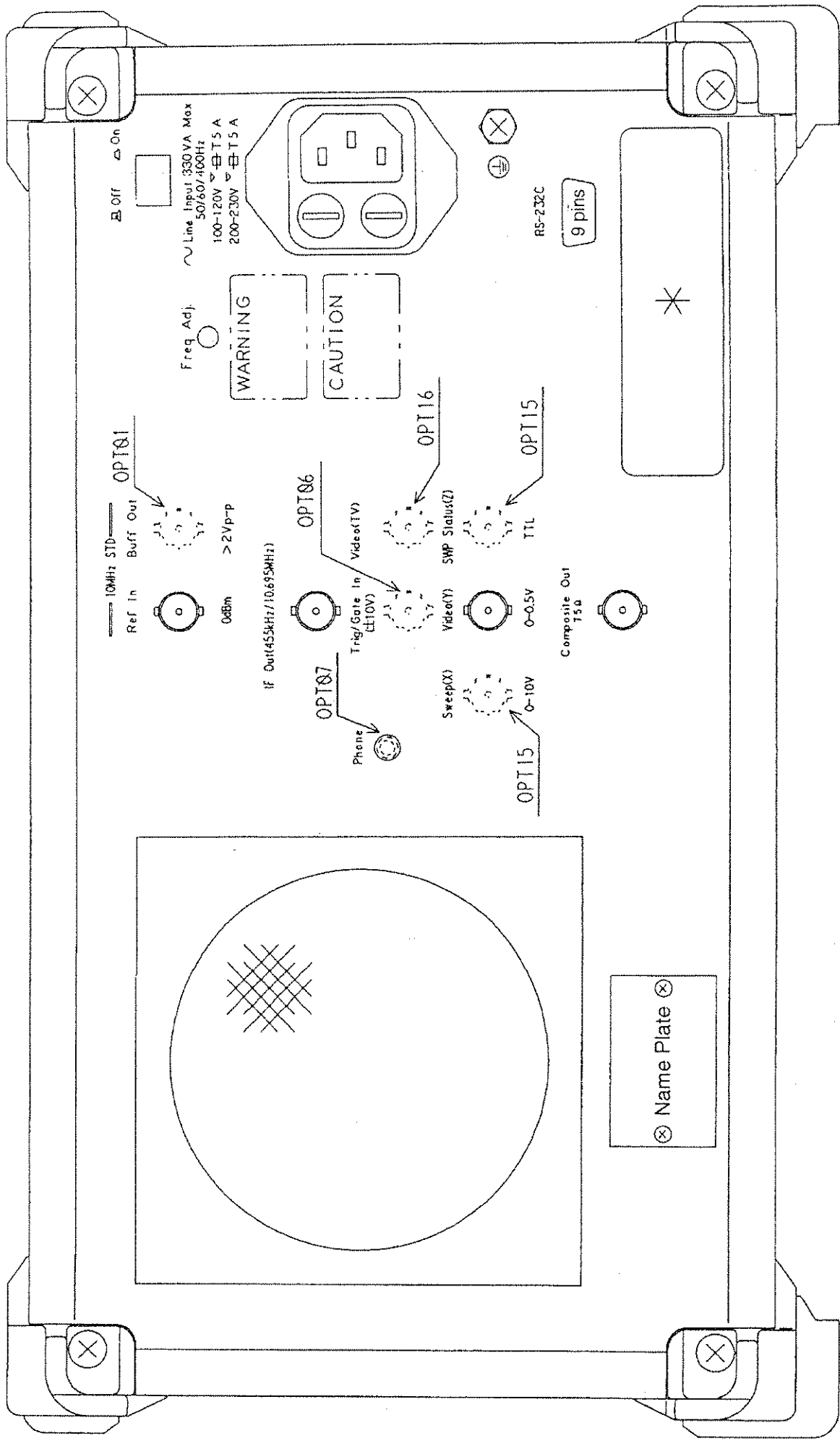
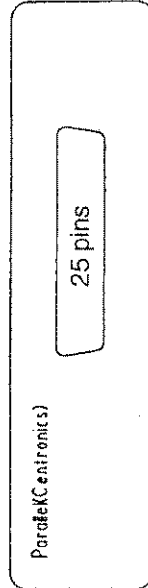

Fig. A-11 MS2663C Front Panel



*; OPT10



*; Standard

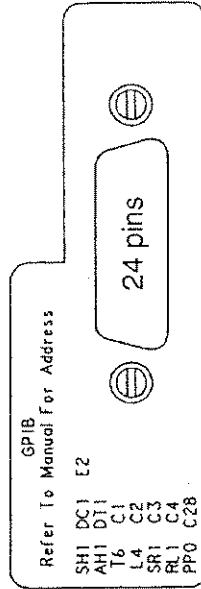

Fig. A-12 MS2661C/2663C Rear Panel

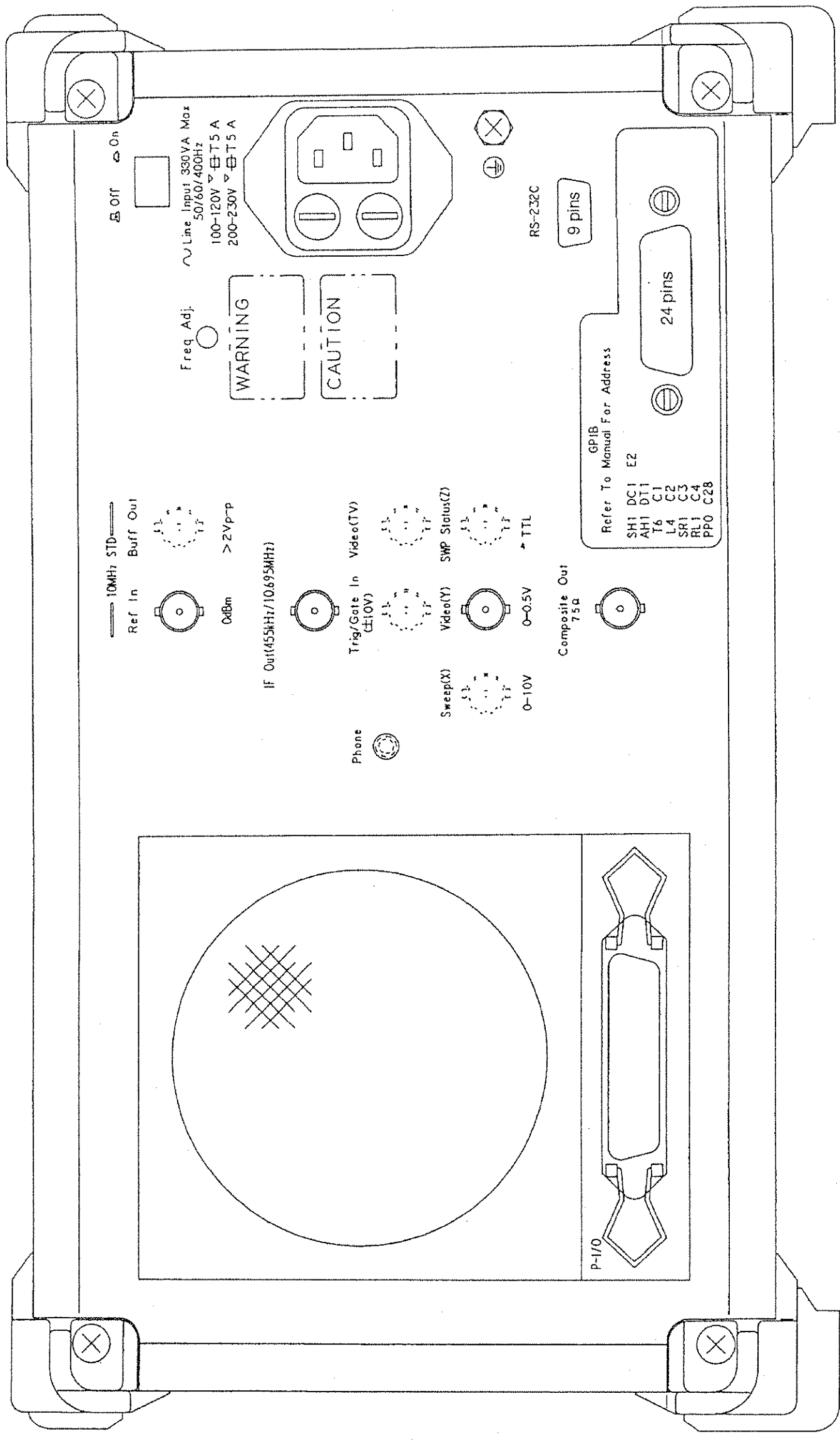

Fig. A-13 MS2661C/2663C (with Opt.14)
Rear Panel

APPENDIX B BLOCK DIAGRAM

This appendix shows the Block Diagram of the MS2651B/MS2661B and MS2653B/MS2663B and MS2661C and MS2663C.

Fig. NO.	Name
Fig. B-1	MS2651B/2661B Block Diagram (1/4)
Fig. B-2	MS2651B/2661B Block Diagram (2/4)
Fig. B-3	MS2651B/2661B Block Diagram (3/4)
Fig. B-4	MS2651B/2661B Block Diagram (4/4)
Fig. B-5	MS2653B/2663B Block Diagram (1/4)
Fig. B-6	MS2653B/2663B Block Diagram (2/4)
Fig. B-7	MS2653B/2663B Block Diagram (3/4)
Fig. B-8	MS2653B/2663B Block Diagram (4/4)
Fig. B-9	MS2661C Block Diagram (1/4)
Fig. B-10	MS2661C Block Diagram (2/4)
Fig. B-11	MS2661C Block Diagram (3/4)
Fig. B-12	MS2661C Block Diagram (4/4)
Fig. B-13	MS2663C Block Diagram (1/4)
Fig. B-14	MS2663C Block Diagram (2/4)
Fig. B-15	MS2663C Block Diagram (3/4)
Fig. B-16	MS2663C Block Diagram (4/4)



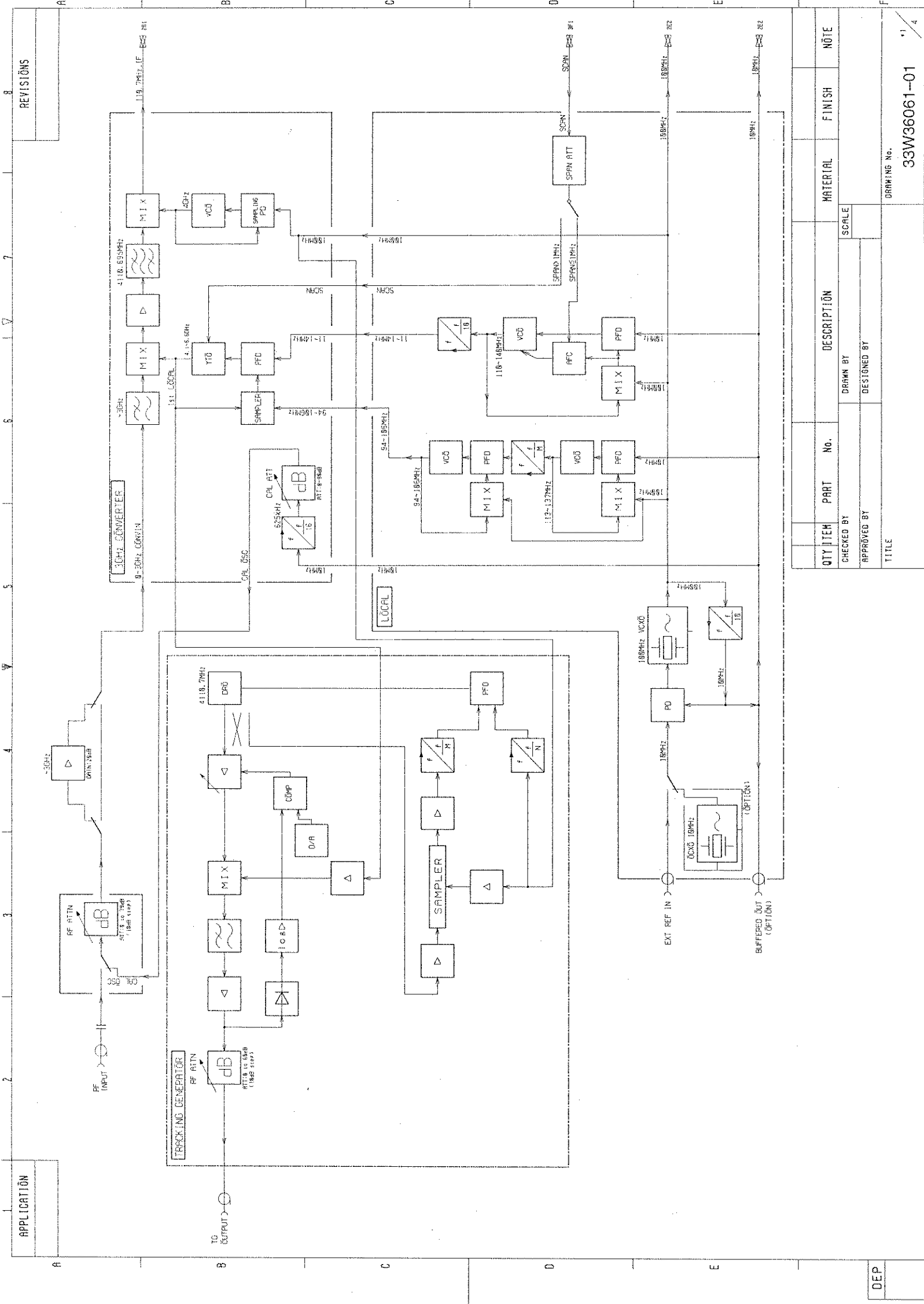

APPLICATION

REVISIONS

DEP

QTY	ITEM	PART No.	DESCRIPTION	MATERIAL	FINISH	NOTE
CHECKED BY			DRAWN BY	SCALE		
APPROVED BY			DESIGNED BY			
TITLE			DRAMAING No.	33W36061-01		1/4

ANRITSU CORP.

Fig. B-1 MS2651B/2661B Block Diagram (1/4)

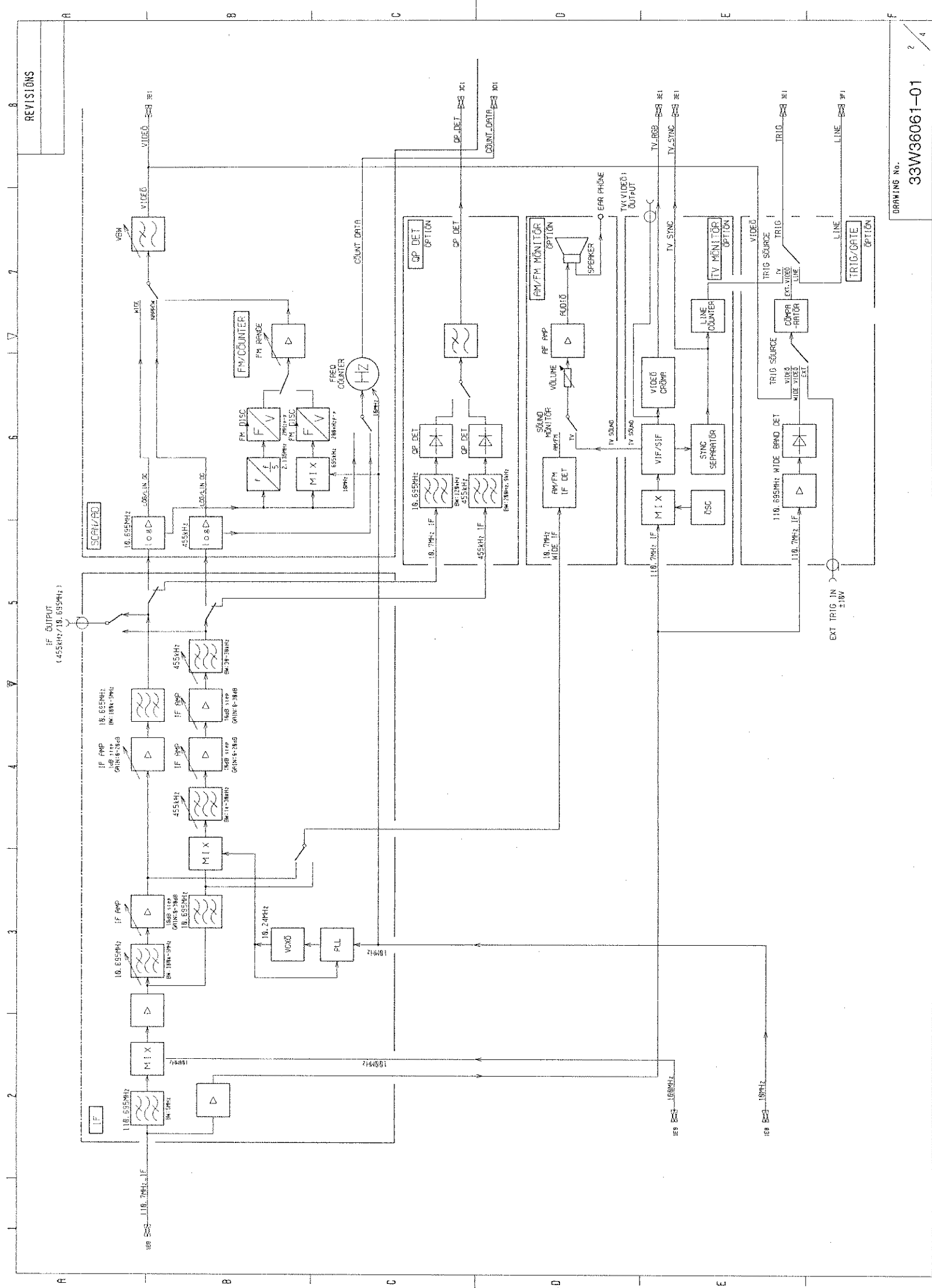

REVISIONS

DRAWING NO. 33W36061-01

ANRITSU CORP.

Fig. B-2 MS2651B/2661B Block Diagram (2/4)

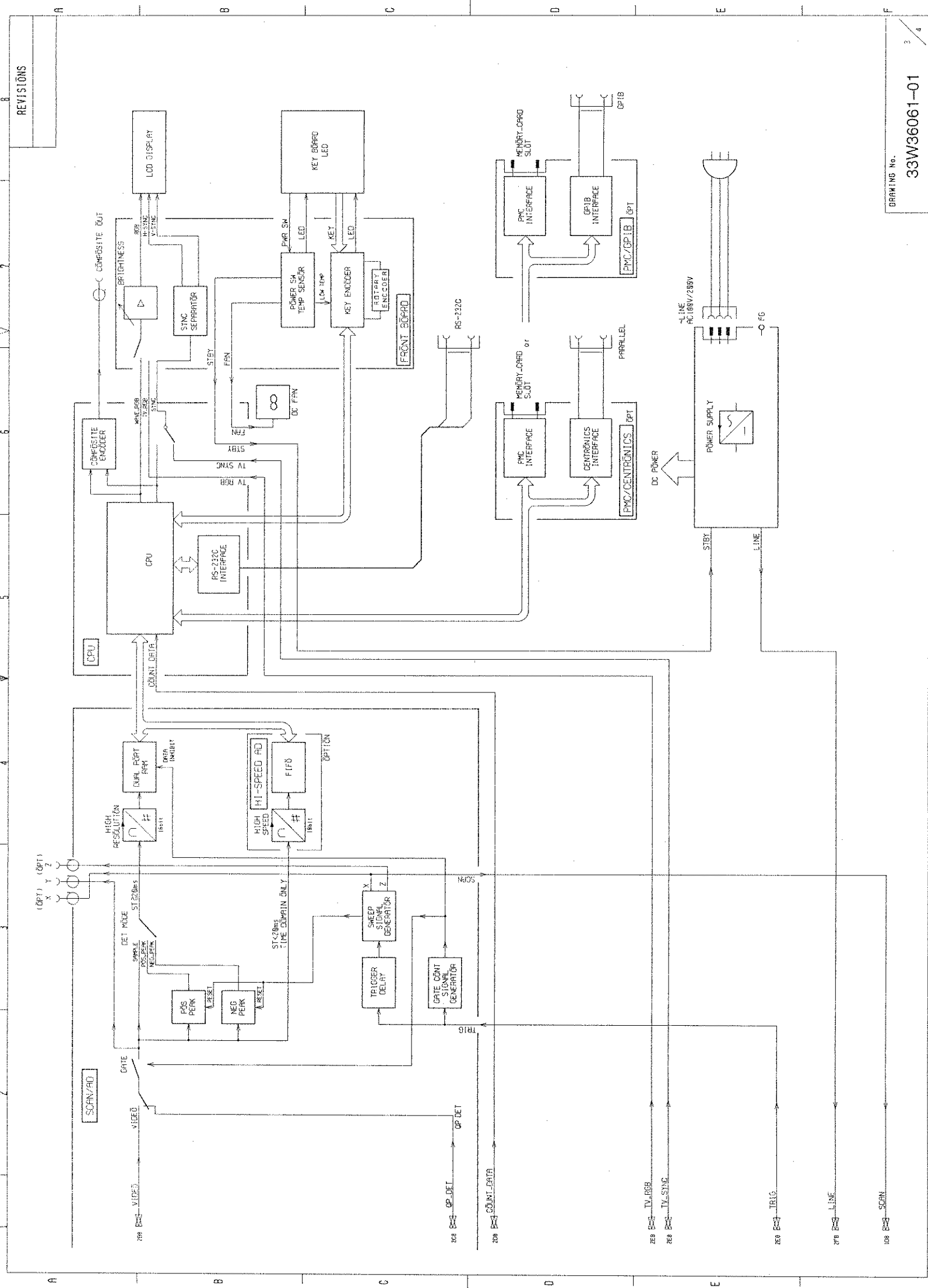

Fig. B-3 MS2651B/2661B Block Diagram (3/4)

DRAWING No. 33W36061-01

ANRITSU CORP.

|

|

C

D

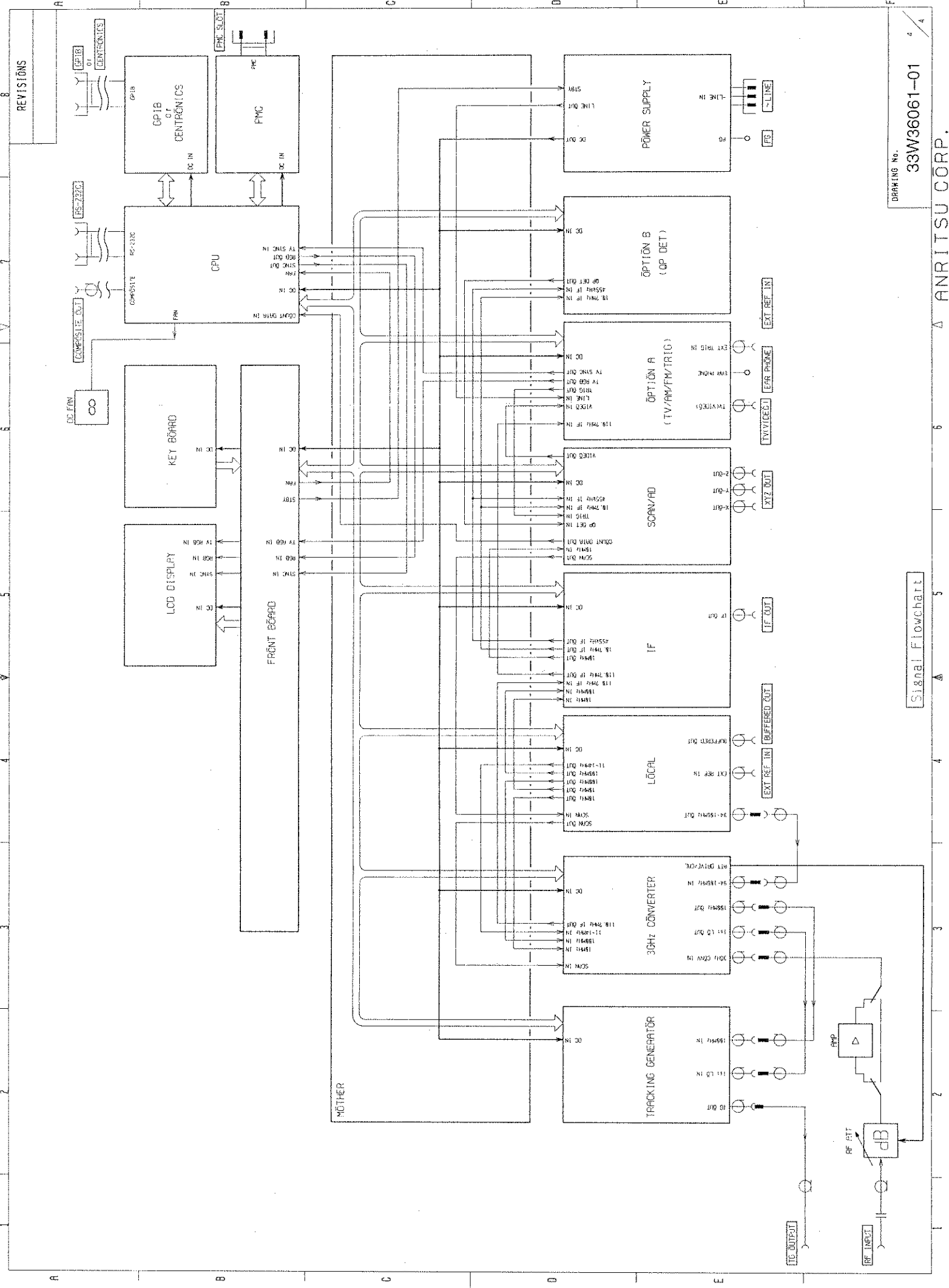

DRAWING NO. 33W36061-01

ANRITSU CORP.

Signal Flowchart

Fig. B-4 MS2651B/2661B Block Diagram (4/4)

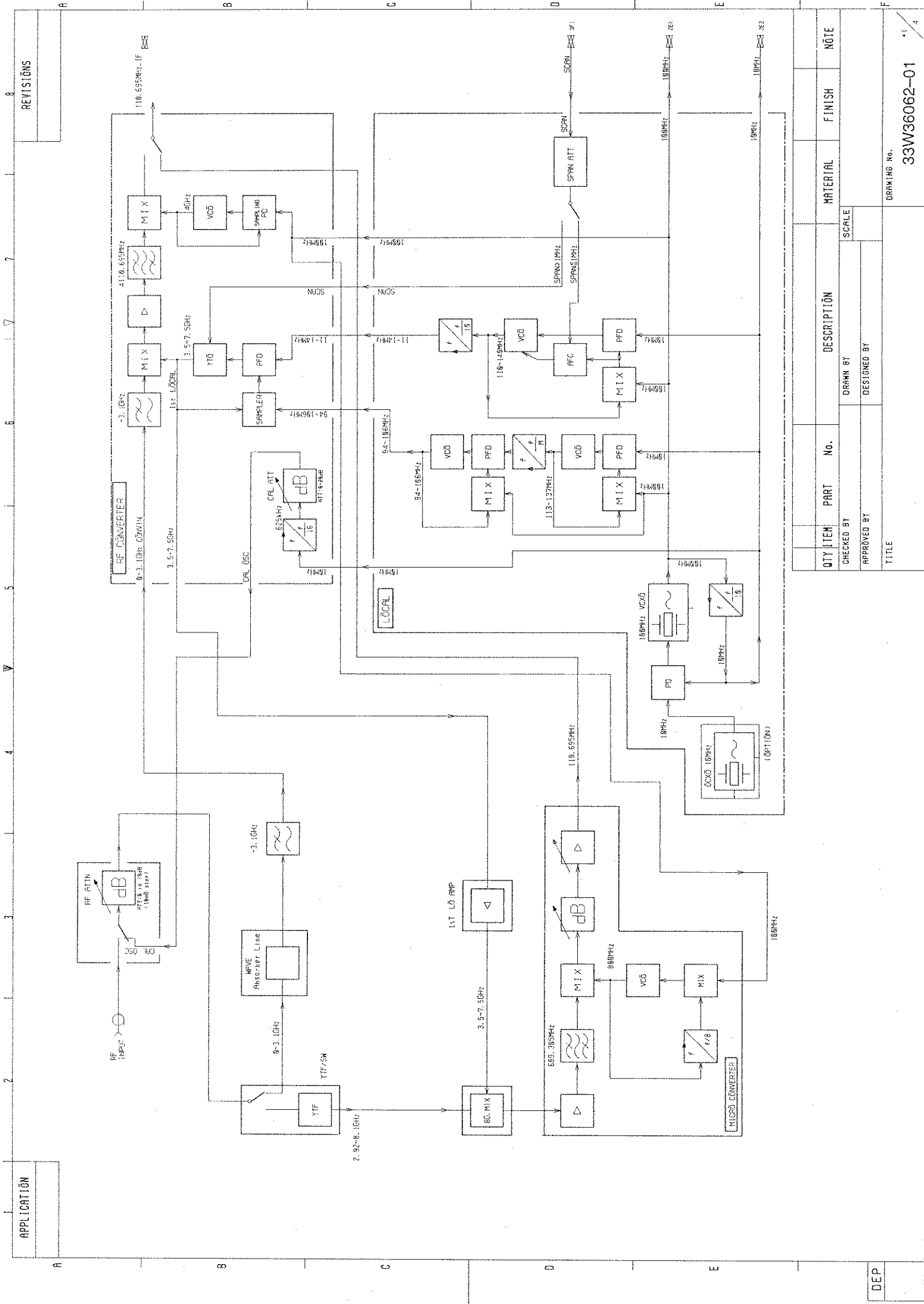
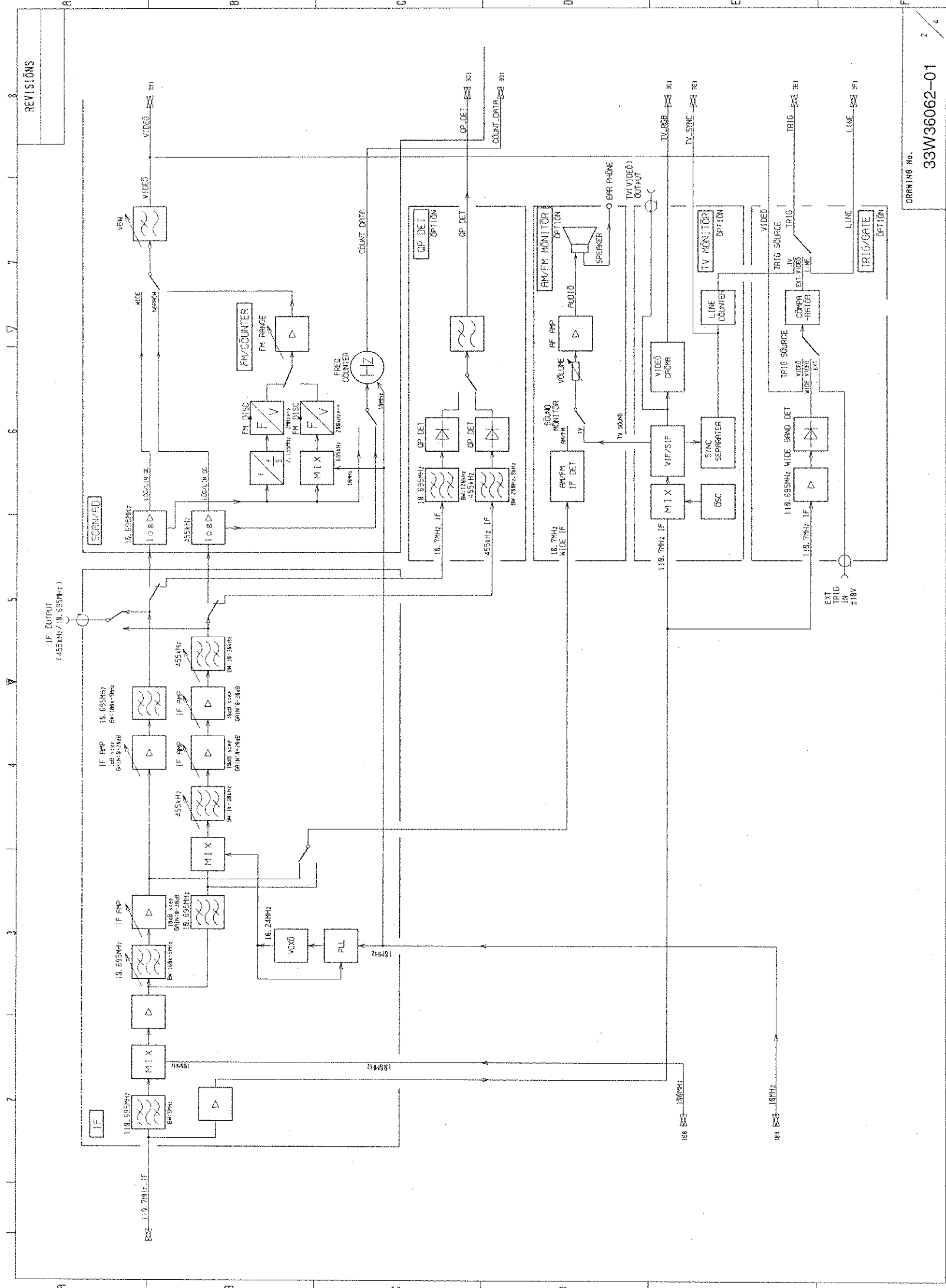

Fig. B-5 MS2653B/2663B Block Diagram (1/4)



REVISIONS

DRAWING No. 33W36062-01 2/4

ANRITSU CORP.

Fig. B-6 MS2653B/2663B Block Diagram (2/4)

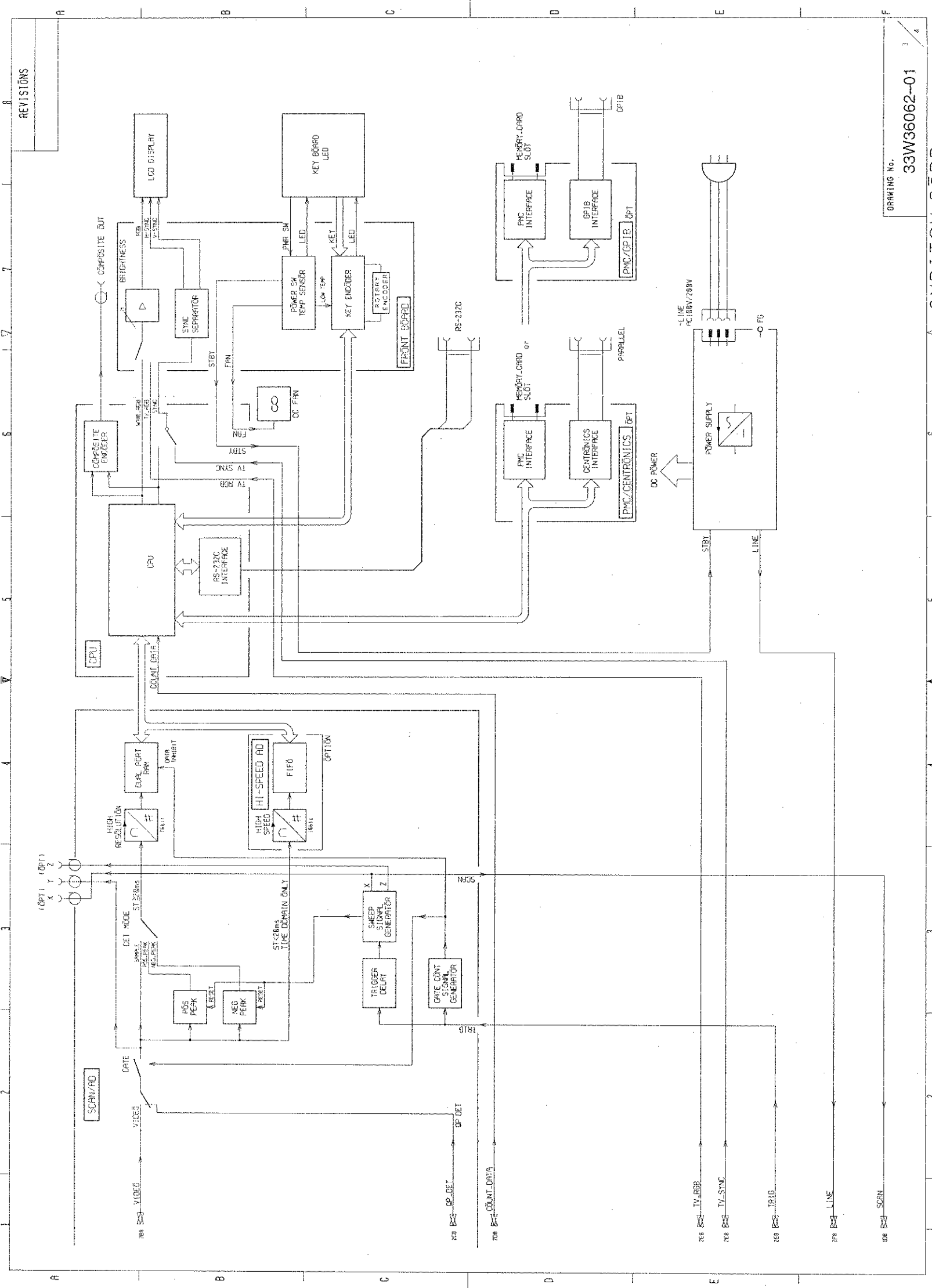

Fig. B-7 MS2653B/2663B Block Diagram (3/4)

DRAWING No. 33W36062-01

ANRITSU CORP.

S

D

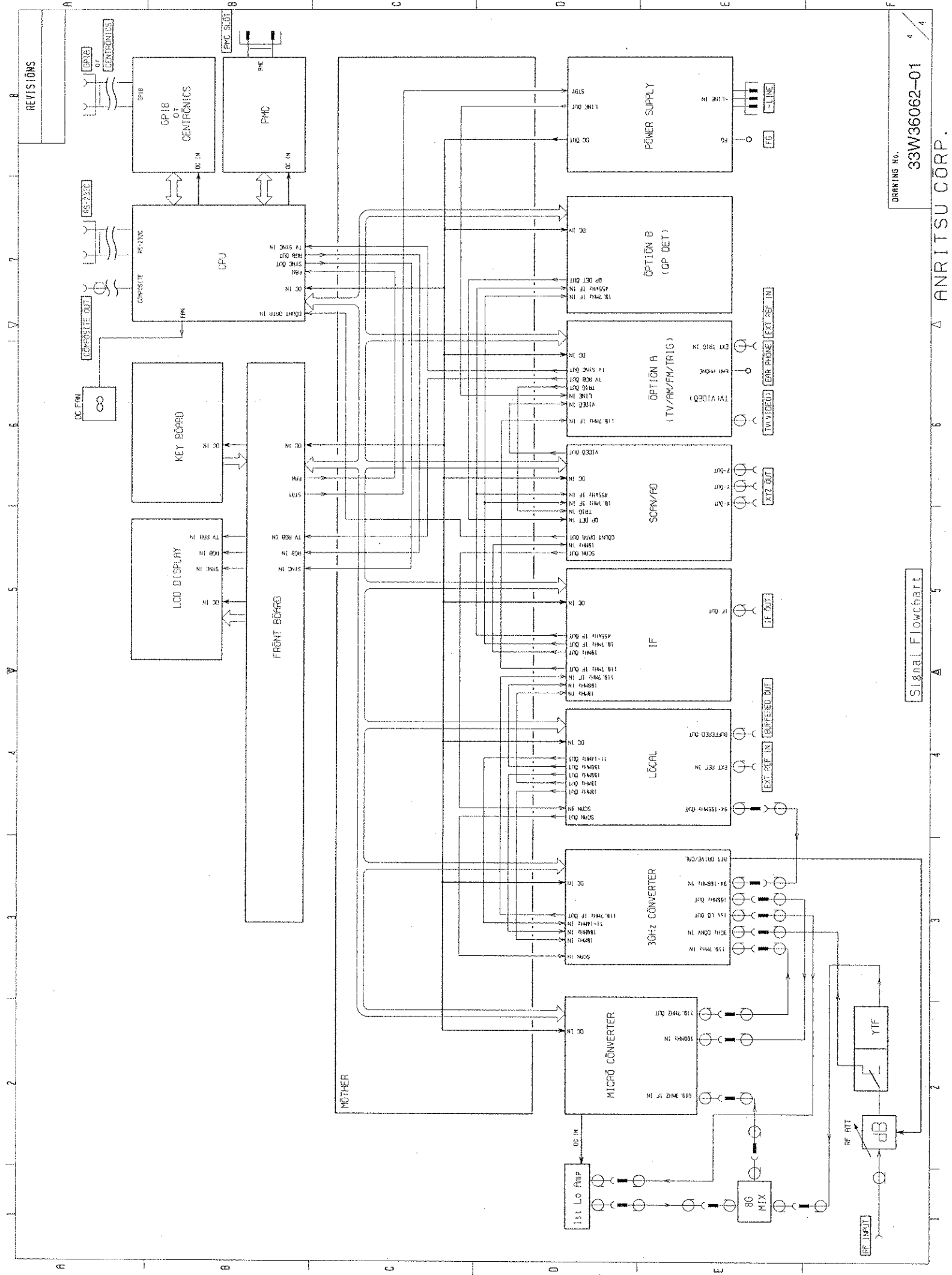

Signal Flowchart

DRAWING NO. 33W36062-01 4/4

ANRITSU CORP.

Fig. B-8 MS2653B/2663B Block Diagram (4/4)

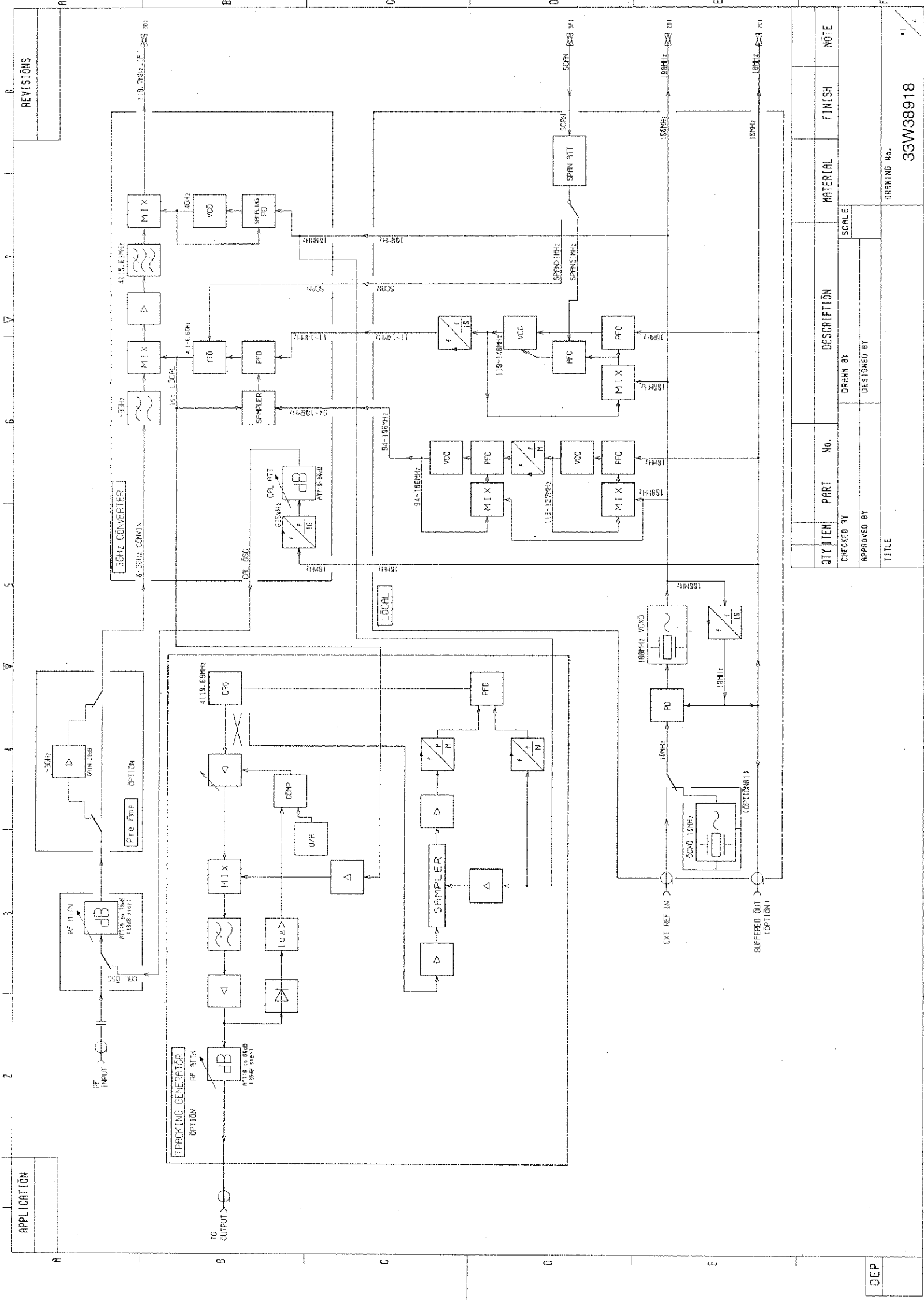

Fig. B-9 MS2661C Block Diagram (1/4)

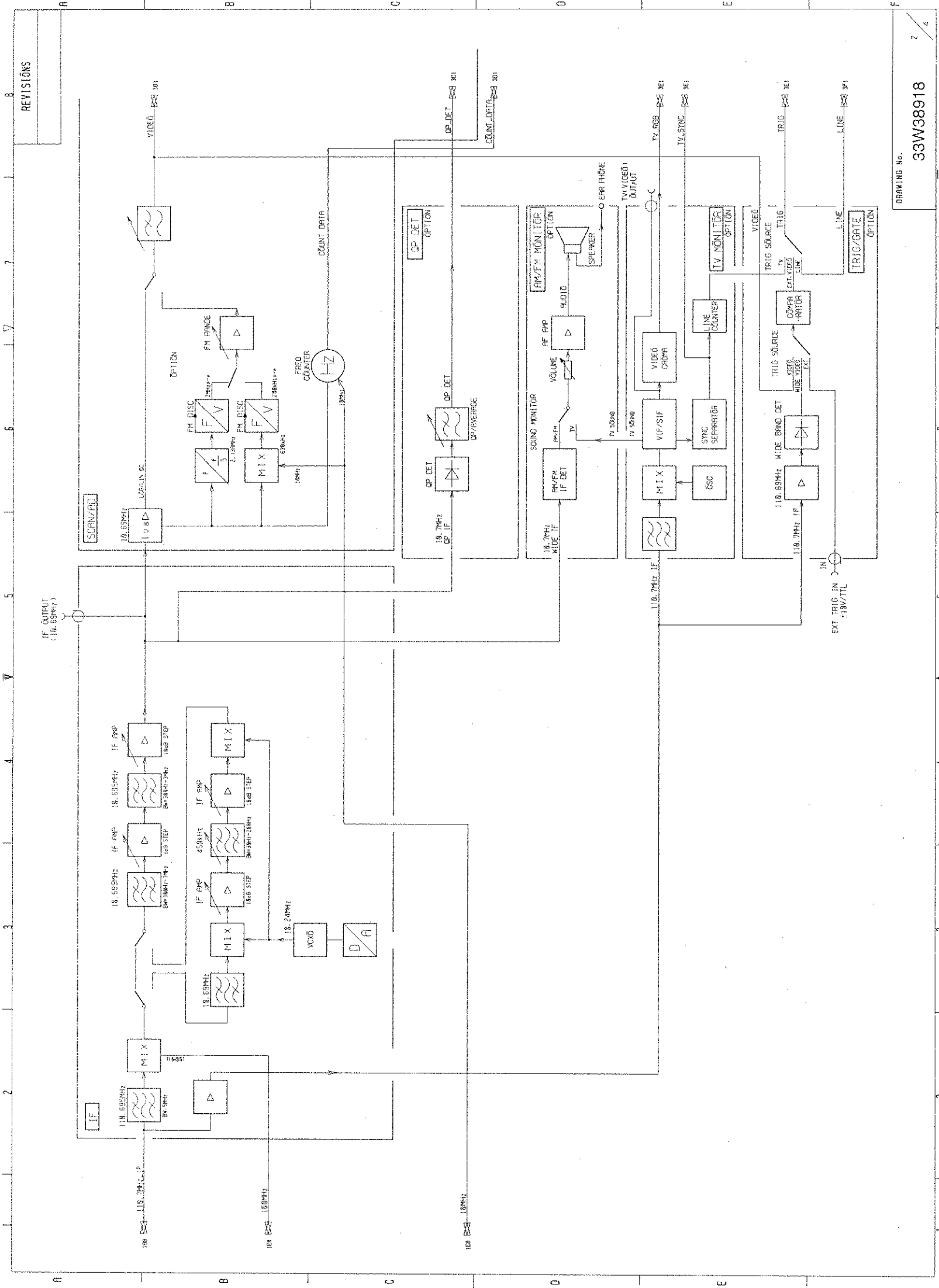
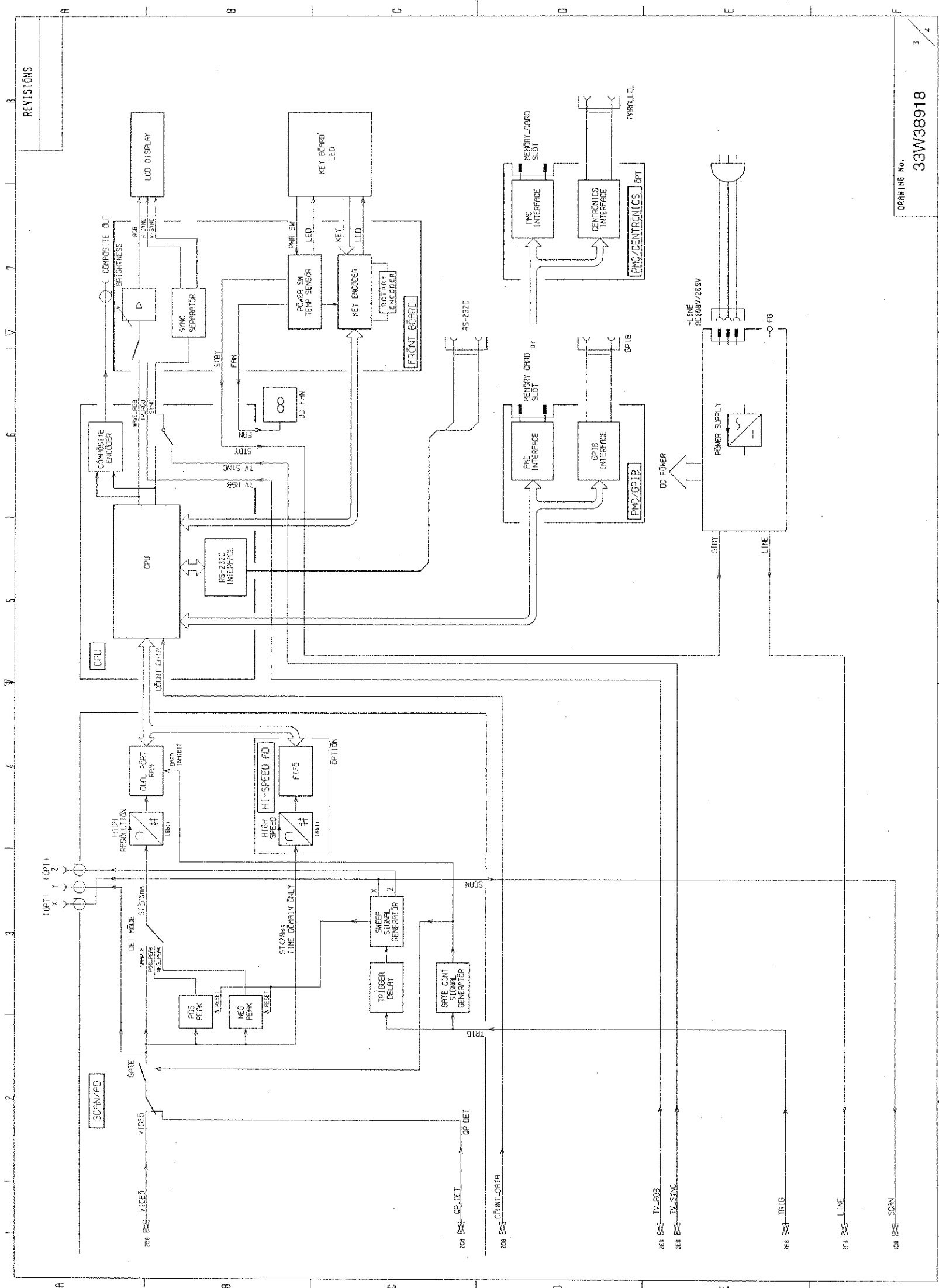

Fig. B-10 MS2661C Block Diagram (2/4)



REVISIONS

DRAWING No. 33W38918
3/4

ANRITSU CORP.

Fig. B-11 MS2661C Block Diagram (3/4)

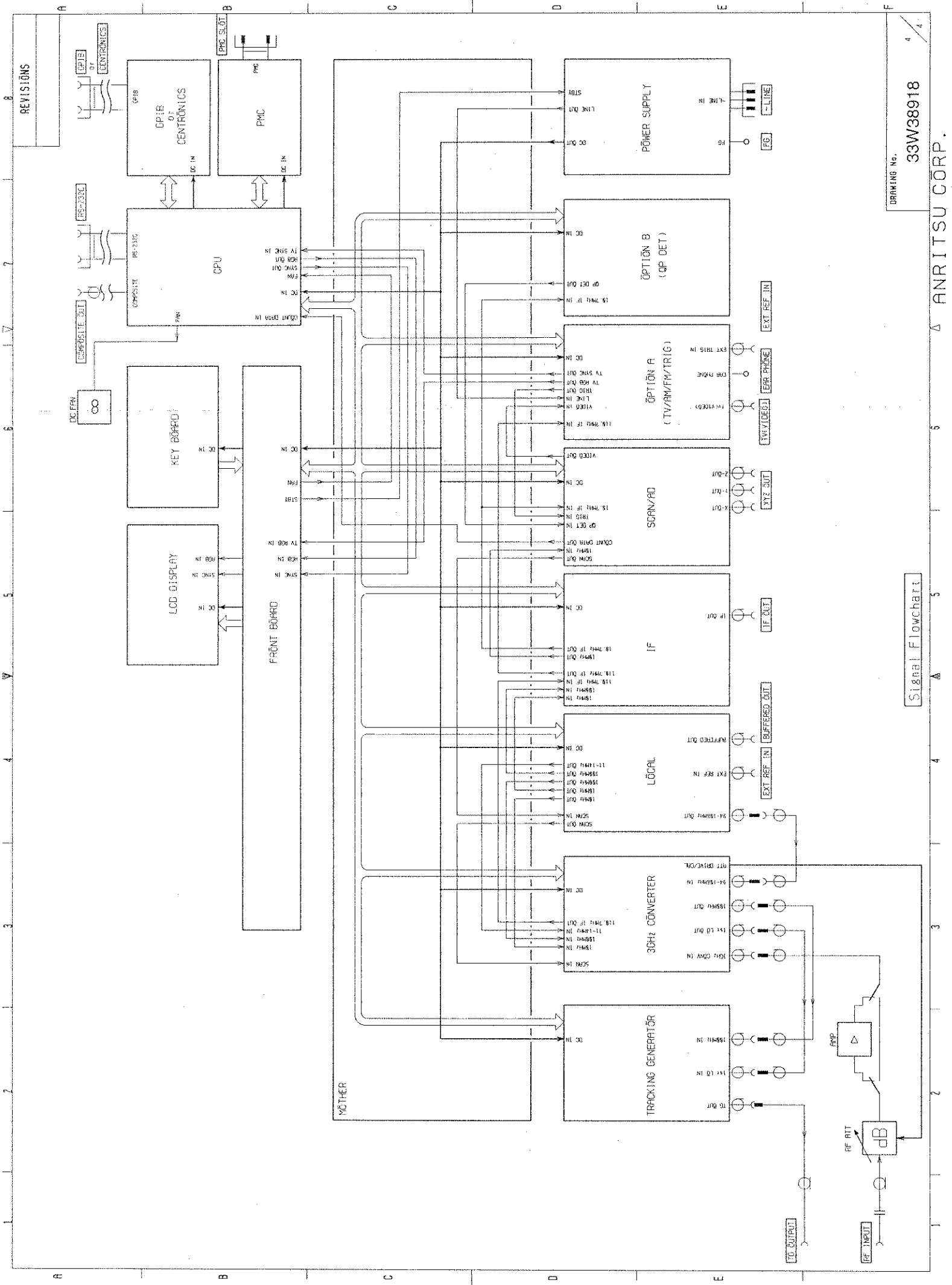

Fig. B-12 MS2661C Block Diagram (4/4)

0

0

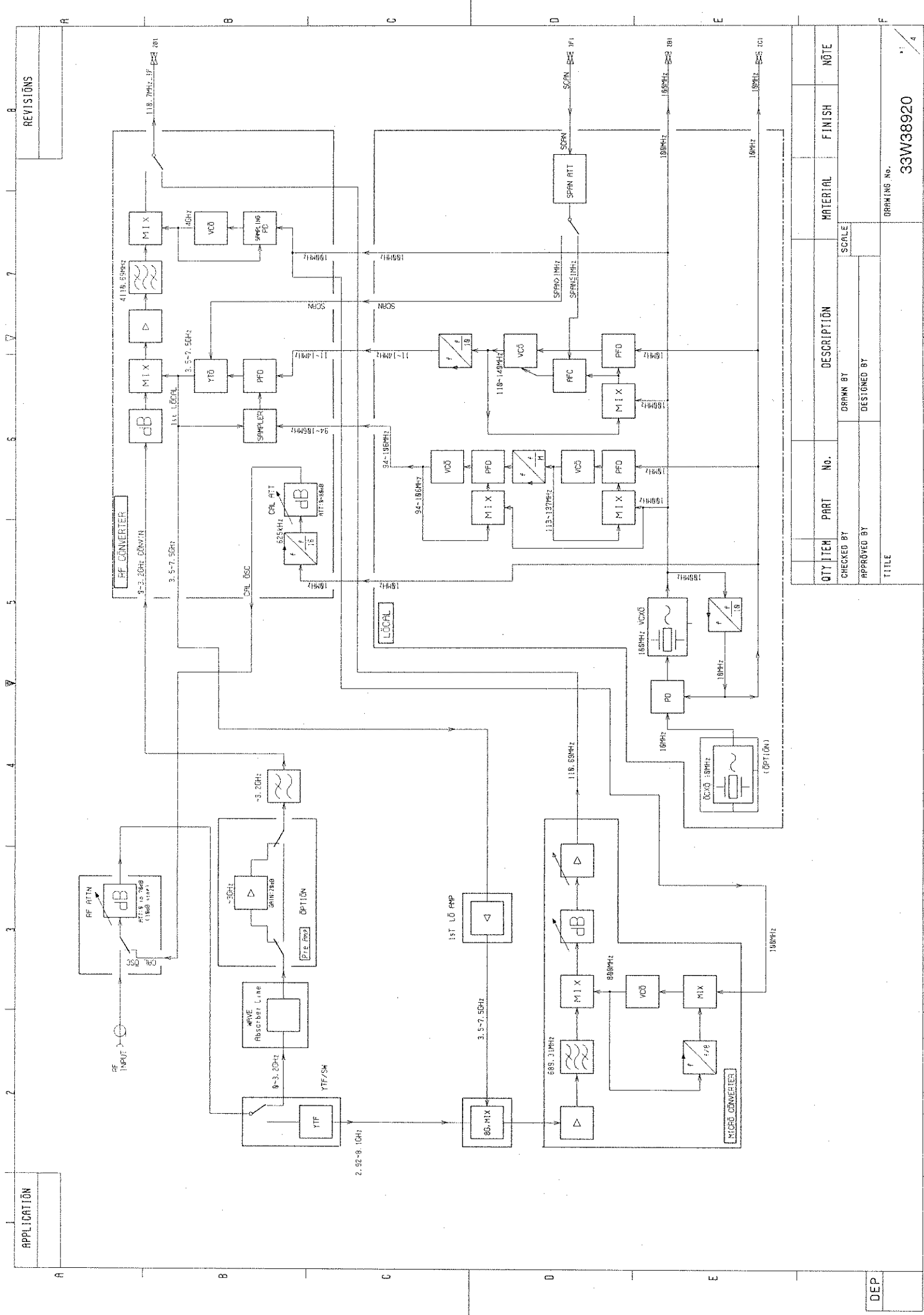

Fig. B-13 MS2663C Block Diagram (1/4)

APPLICATION		REVISONS	
DEP			
TITLE		DRAWING No.	
CHECKED BY		DRAWN BY	
APPROVED BY		DESIGNED BY	
QTY	ITEM	PART No.	DESCRIPTION
			MATERIAL
			FINISH
			NOTE
		33W38920	
		ANRITSU CORP.	

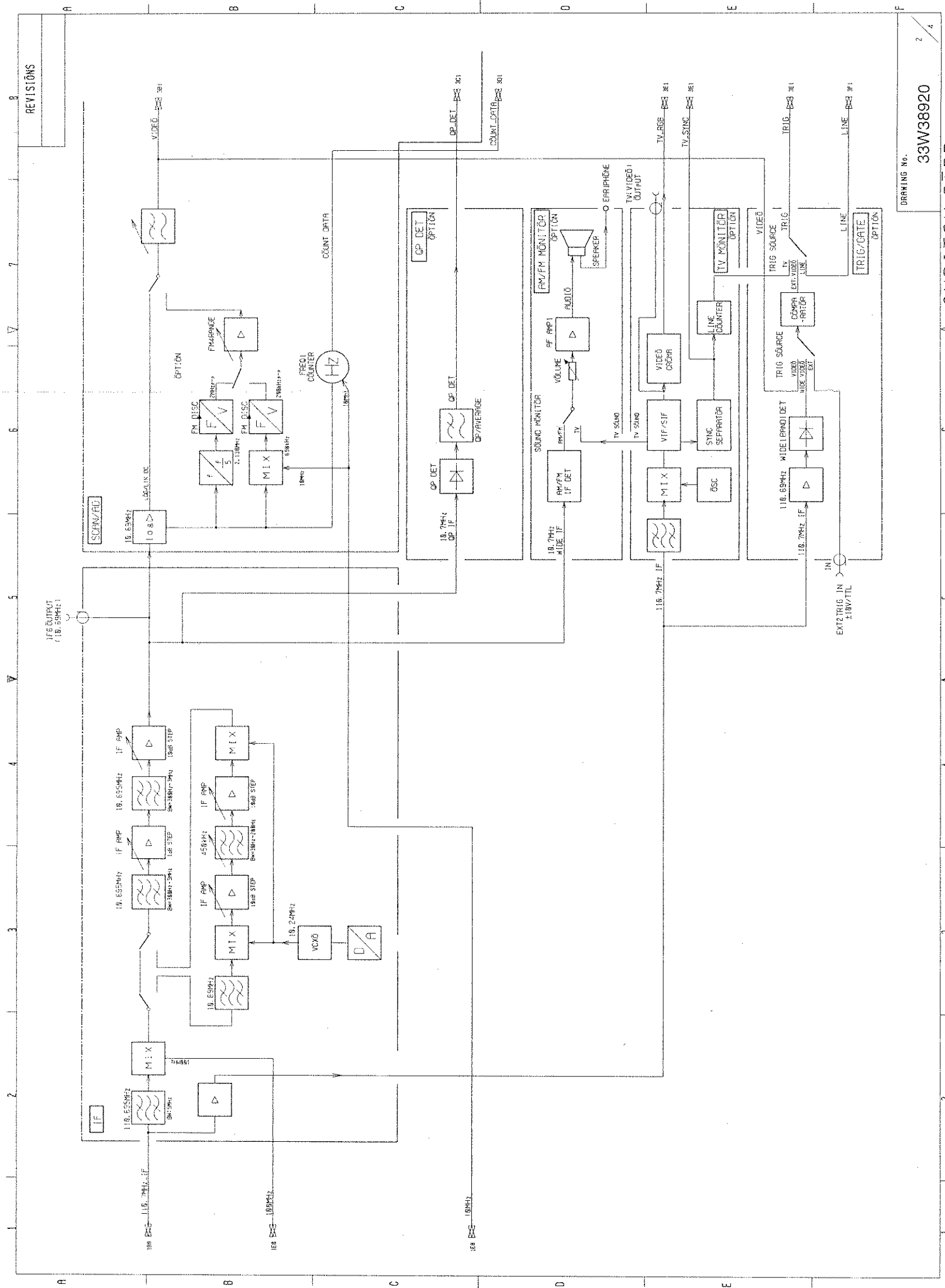
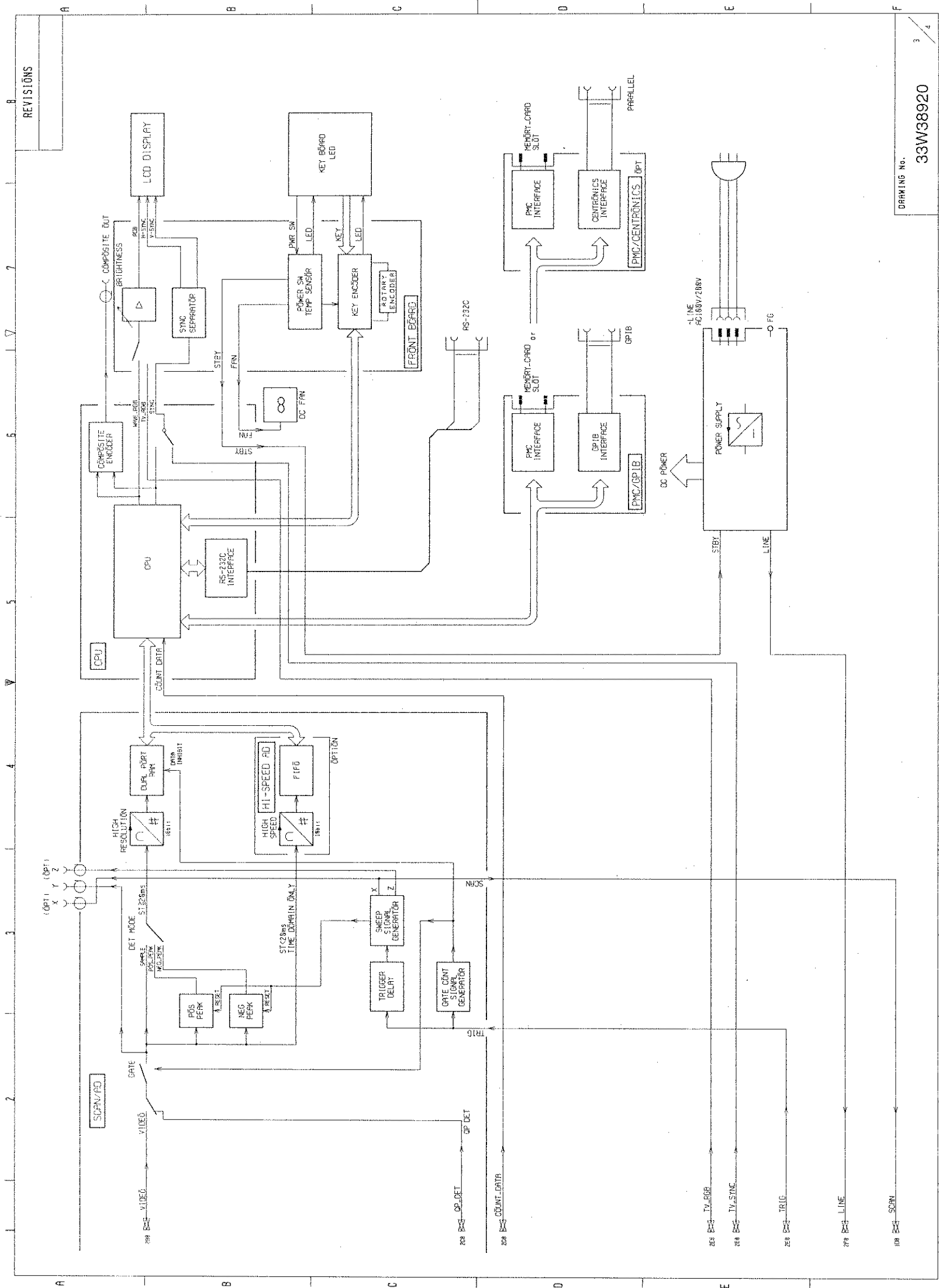

Fig. B-14 MS2663C Block Diagram (2/4)

DRAWING No. 33W38920

ANRITSU CORP.



REVISIONS

DRAWING NO. 33W38920
3/4

ANRITSU CORP.

Fig. B-15 MS2663C Block Diagram (3/4)

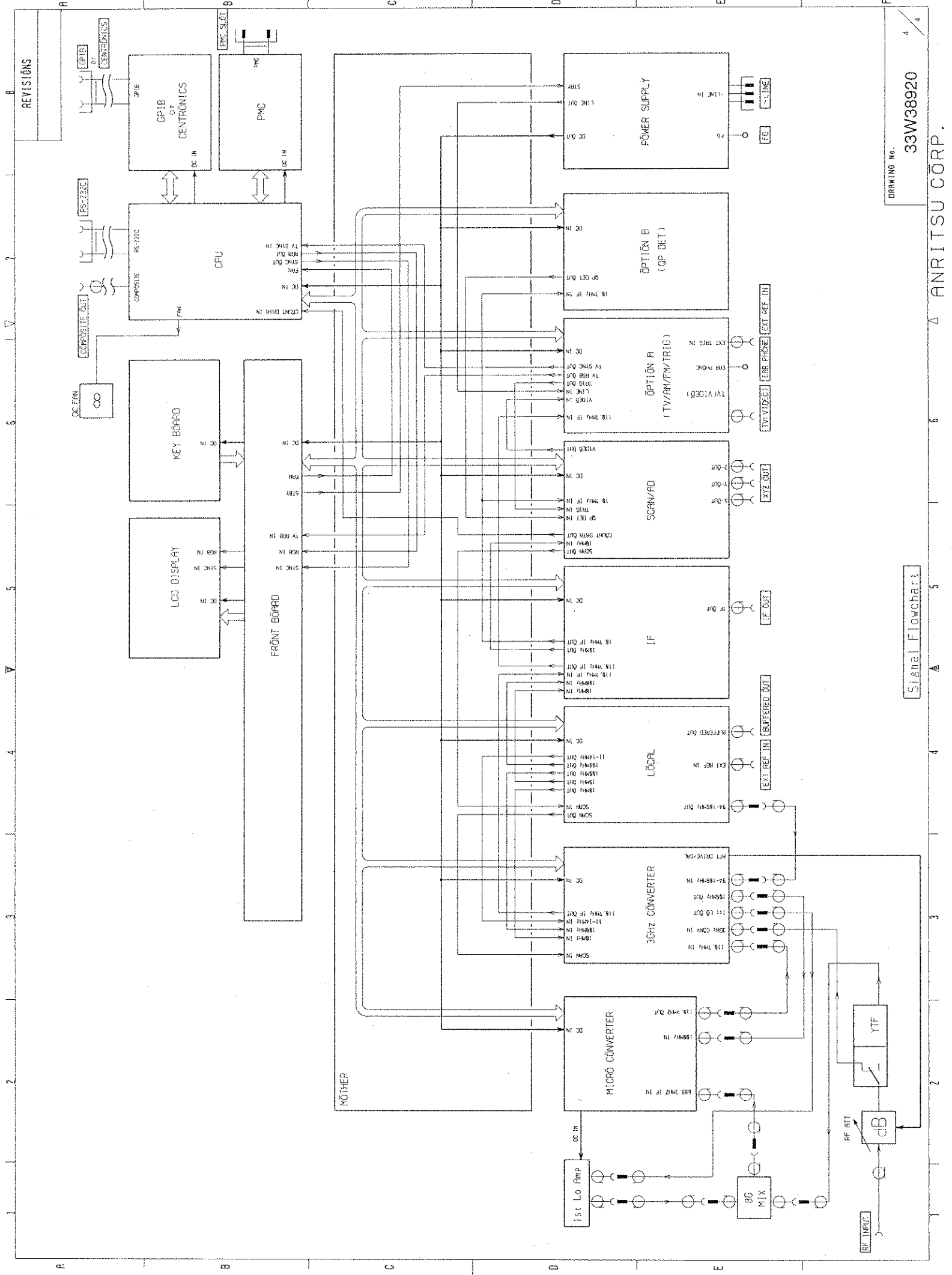

Fig. B-16 MS2663C Block Diagram (4/4)

APPENDIX C
PERFORMANCE TEST RECORD



Performance Test Record

(1/13)

NO. _____

DATE _____

MODEL _____

SERIAL NO _____

OPTIONS _____

Date _____

Tested by _____

Ambient temperature _____ °C

Relative humidity _____ %

Power mains line voltage (nominal) _____ Vac

Powermains line frequency (nominal) _____ Hz

Test Equipment used

Descriptions	MODEL NO.	Cal Date
Synthesized signal generator		
Synthesized Sweeper		
Attenuator		
Power meter		
Power senser		
Power senser		
50Ω Termination		
Low pass filter		
Frequency counter		
Frequency standard		

MODEL NAME _____

DATE _____

SERIAL NO. _____

Tested by _____

Reference oscillator stability

● Frequency stability (aging rate)

Description	Min.	Result	Max.
Frequency stability/day	-2×10^{-8}		$+2 \times 10^{-8}$

● Temperature stability

Description	Min.	Result	Max.
Temperature stability	-5×10^{-8}		$+5 \times 10^{-8}$

Frequency readout accuracy

● MS2651B/2661B/2661C

Signal generator	Center frequency	Span frequency	Readout frequency		
			Min.	Marker Value	Max.
500MHz	500MHz	10kHz	499.999 66MHz		500.000 34MHz
		200kHz	499.995 2MHz		500.004 8MHz
		100MHz	497.6MHz		502.4MHz

● MS2653B/2663B/2663C

Signal generator	Center frequency	Span frequency	Band	Readout frequency		
				Min.	Marker Value	Max.
500MHz	500MHz	10kHz	0	499.999 66MHz		500.000 34MHz
		200kHz		499.995 2MHz		500.004 8MHz
		100MHz		497.6MHz		502.4MHz
5GHz	5GHz	10kHz	1 ⁺	4.999 999 66GHz		5.000 000 34GHz
		200kHz		4.999 995 2GHz		5.000 004 8GHz
		100MHz		4.997 6GHz		5.002 4GHz
7.5GHz	7.5GHz	10kHz	1 ⁺	7.499 999 66GHz		7.500 000 34GHz
		200kHz		7.499 995 2GHz		7.500 004 8GHz
		100MHz		7.497 6GHz		7.502 4GHz

(3/13)

MODEL NAME _____ DATE _____

SERIAL NO. _____

Tested by _____

Frequency span readout

• MS2651B/2661B/2661C

SPA		Signal generator		Result		
Center frequency	Span frequency	f ₁ (GHz)	f ₂ (GHz)	Min.	$\frac{f_2-f_1}{0.8}$	Max.
1GHz	20kHz	0.999 992	1.000 008	19.5kHz		20.5kHz
	200kHz	0.999 92	1.000 08	195kHz		205kHz
	2MHz	0.999 2	1.000 8	1.95MHz		2.05MHz
	10MHz	0.996	1.004	9.75MHz		10.25MHz
	100MHz	0.96	1.04	97.5MHz		102.5MHz
	2GHz	0.2	1.8	1.95GHz		2.05GHz

• MS2653B/2663B/2661C

SPA		Signal generator		Result		
Center frequency	Span frequency	f ₁ (GHz)	f ₂ (GHz)	Min.	$\frac{f_2-f_1}{0.8}$	Max.
1GHz	20kHz	0.999 992	1.000 008	19.5kHz		20.5kHz
	200kHz	0.999 92	1.000 08	195kHz		205kHz
	2MHz	0.999 2	1.000 8	1.95MHz		2.05MHz
	10MHz	0.996	1.004	9.75MHz		10.25MHz
	100MHz	0.96	1.04	97.5MHz		102.5MHz
	2GHz	0.2	1.8	1.95GHz		2.05GHz
4.05GHz	100MHz	4.21	4.29	97.5MHz		102.5MHz
	1GHz	3.85	4.65	0.975GHz		1.025GHz
	8.1GHz	0.81	7.29	7.8975GHz		8.3025GHz

MODEL NAME _____

DATE _____

SERIAL NO. _____

Tested by _____

Resolution bandwidth accuracy

• MS2651B/2661B/2653B/2663B

Resolution Bandwidth	Span	Bandwidth(3dB)
5MHz	10MHz	
1MHz	5MHz	
300kHz	500kHz	
100kHz	200kHz	
30kHz	50kHz	
10kHz	20kHz	
3kHz	5kHz	
1kHz	2kHz	

• MS2661C/2663C

Resolution Bandwidth	Span	Bandwidth(3dB)	Specification
3MHz	10MHz		±30%
1MHz	5MHz		±20%
300kHz	500kHz		±20%
100kHz	200kHz		±20%
30kHz	50kHz		±20%
10kHz	20kHz		±20%
3kHz	5kHz		±20%
1kHz	2kHz		±20%

(5/13)

MODEL NAME _____

DATE _____

SERIAL NO. _____

Tested by _____

Resolution bandwidth selectivity

• MS2651B/2661B/2653B/2663B

Resolution Bandwidth	Frequency Span	Video Bandwidth	60dB BW	3dB BW	60dB BW/ 3dB BW
5MHz	100MHz	100Hz			≤15
1MHz	20MHz	100Hz			≤15
300kHz	10MHz	100Hz			≤10
100kHz	5MHz	100Hz			≤10
30kHz	1MHz	100Hz			≤10
10kHz	200kHz	100Hz			≤10
3kHz	100kHz	100Hz			≤10
1kHz	50kHz	100Hz			≤10

• MS2661C/2663C

Resolution Bandwidth	Frequency Span	Video Bandwidth	60dB BW	3dB BW	60dB.BW/ 3dB BW
3MHz	100MHz	100Hz			≤15
1MHz	20MHz	100Hz			≤15
300kHz	10MHz	100Hz			≤15
100kHz	5MHz	100Hz			≤15
30kHz	1MHz	100Hz			≤15
10kHz	200kHz	100Hz			≤15
3kHz	100kHz	100Hz			≤15
1kHz	50kHz	100Hz			≤15

Sideband phase noise

• MS2651B/2653B

Center frequency	Results	Specification
1GHz		≤-90dBc/Hz

• MS2661B/2663B/2661C/2663C

Center frequency	Results	Specification
1GHz		≤-100dBc/Hz

MODEL NAME _____

DATE _____

SERIAL NO. _____

Tested by _____

Frequency measurement accuracy

Signal generator	Measurement Resokution	Min.	Reaults	Max.
500MHz	1Hz	499.999 999MHz	_____	500.000 001MHz
500MHz	10Hz	499.999 99MHz	_____	500.000 01MHz
500MHz	100Hz	499.999 9MHz	_____	500.000 1MHz
500MHz	1kHz	499.999MHz	_____	500.001MHz

Amplitude display accuracy

• Log scale Fidelity

ATT setting(dB)	A	B	Error (dB)=A+B	Spec
	ATT Calibration factor (dB)	Δ marker readout (dB)		
0	0(reference)		0(reference)	0(reference)
5	_____	_____	_____	±0.4dB
10	_____	_____	_____	±0.4dB
15	_____	_____	_____	±0.4dB
20	_____	_____	_____	±0.4dB
25	_____	_____	_____	±1.0dB
30	_____	_____	_____	±1.0dB
35	_____	_____	_____	±1.0dB
40	_____	_____	_____	±1.0dB
45	_____	_____	_____	±1.0dB
50	_____	_____	_____	±1.0dB
55	_____	_____	_____	±1.0dB
60	_____	_____	_____	±1.0dB
65	_____	_____	_____	±1.0dB
70	_____	_____	_____	±1.0dB
75	_____	_____	_____	±1.5dB
80	_____	_____	_____	±1.5dB
85	_____	_____	_____	±1.5dB
90	_____	_____	_____	±2.5dB

(7/13)

MODEL NAME _____

DATE _____

SERIAL NO. _____

Tested by _____

Frequency response

• MS2651B/2661B/2661C

Signal generator	Calibration level (dBm)	Marker level (dB)	Deviation	Spec.
100MHz	0(reference)	0(reference)	0(reference)	0(reference)
200MHz	_____	_____	_____	±0.5dB
500MHz	_____	_____	_____	±0.5dB
1GHz	_____	_____	_____	±0.5dB
1.5GHz	_____	_____	_____	±0.5dB
2.0GHz	_____	_____	_____	±0.5dB

• MS2653B/2663B/2663C

Signal generator	Band (mixing order)	Calibration level (dBm)	Marker level (dB)	Deviation	Spec.
100MHz	0(1)	0(reference)	0(reference)	0(reference)	0(reference)
200MHz	0(1)	_____	_____	_____	±0.5dB
500MHz	0(1)	_____	_____	_____	±0.5dB
1GHz	0(1)	_____	_____	_____	±0.5dB
1.5GHz	0(1)	_____	_____	_____	±0.5dB
2.0GHz	0(1)	_____	_____	_____	±0.5dB
3.0GHz	0(1)	_____	_____	_____	±0.5dB
3.1GHz	1*(1)	_____	_____	_____	±1.0dB
4GHz	1*(1)	_____	_____	_____	±1.0dB
5GHz	1*(1)	_____	_____	_____	±1.0dB
6GHz	1*(1)	_____	_____	_____	±1.0dB
6.5GHz	1*(1)	_____	_____	_____	±1.0dB
6.5GHz	1*(1)	_____	_____	_____	±1.0dB
7GHz	1*(1)	_____	_____	_____	±1.0dB
7.5GHz	1*(1)	_____	_____	_____	±1.0dB
8GHz	1*(1)	_____	_____	_____	±1.0dB

MODEL NAME _____

DATE _____

SERIAL NO. _____

Tested by _____

Reference level accuracy

Reference Level setting	Marker readout	Correction factor of ATT	Error*1	Spec.
0dBm				±0.4dB
-10dBm				±0.4dB
-20dBm				±0.4dB
-30dBm				±0.4dB
-40dBm				±0.4dB
-50dBm				±0.75dB
-60dBm				±0.75dB
-70dBm				±1.5dB
-80dBm				±1.5dB

*1: Calculate the "Error" from the following equation

$Error = \text{Marker readout} - \text{Reference Level set value} - \text{corection factor of ATT}$

(9/13)

MODEL NAME _____

DATE _____

SERIAL NO. _____

Tested by _____

Average noise level

• MS2651B

MS2651B setting		Average noise level	
START FREQ	STOP FREQ	Maker readout	Spec.
1MHz	1GHz		-110dBm
1GHz	2GHz		-109 to -108dBm

• MS2661B/2661C

MS2661 setting		Average noise level	
START FREQ	STOP FREQ	Maker readout	Spec.
1MHz	1GHz		-115dBm
1GHz	2GHz		-114 to -113dBm

• MS2653B

MS2653B setting		Average noise level	
START FREQ	STOP FREQ	Maker readout	Spec.
1MHz	1GHz		-110dBm
1GHz	2GHz		-109 to -108dBm
4.0GHz	6.0GHz		-108 to -107dBm
7.0GHz	8.0GHz		-106.5 to -106dBm

• MS2663B/2663C

MS2663 setting		Average noise level	
START FREQ	STOP FREQ	Maker readout	Spec.
1MHz	1GHz		-115dBm
1GHz	2GHz		-114 to -113dBm
4.0GHz	6.0GHz		-113 to -112dBm
7.0GHz	8.0GHz		-115.5 to -111dBm

MODEL NAME _____

DATE _____

SERIAL NO. _____

Tested by _____

Second harmonic distortion

Signal generator	Second harmonic distortion (dB)
10.1MHz	
100.1MHz	
500.1MHz	
800.1MHz	
1000.1MHz	
1499.9MHz	
2000.1MHz	
2500.1MHz	

Resolution bandwidth switching error

MS2650/MS2660 Series setting			
RBW	SPAN	Δ Marker readout	Spec.
1kHz	5kHz		± 0.3 dB
3kHz	15kHz	0dB(reference)	0dB(reference)
10kHz	50kHz		± 0.3 dB
30kHz	150kHz		± 0.3 dB
100kHz	500kHz		± 0.3 dB
300kHz	1.5MHz		± 0.3 dB
1MHz	5MHz		± 0.3 dB
5MHz	10MHz		± 0.4 dB

(11/13)

MODEL NAME _____

DATE _____

SERIAL NO. _____

Tested by _____

Resolution bandwidth uncertainty

• MS2651B/2661B/2653B/2663B

MS2650/2660 series setting		Δ marker readout	Specification
RBW	SPAN		
1kHz	5kHz		$\pm 0.3\text{dB}$
3kHz	15kHz	0.0dB	Reference
10kHz	50kHz		$\pm 0.3\text{dB}$
30kHz	150kHz		$\pm 0.3\text{dB}$
100kHz	500kHz		$\pm 0.3\text{dB}$
300kHz	1.5MHz		$\pm 0.3\text{dB}$
1MHz	5MHz		$\pm 0.3\text{dB}$
5MHz	10MHz		$\pm 0.4\text{dB}$

• MS2661C/2663C

MS2650/2660 series setting		Δ marker readout	Specification
RBW	SPAN		
1kHz	5kHz		$\pm 0.3\text{dB}$
3kHz	15kHz	0.0dB	Reference
10kHz	50kHz		$\pm 0.3\text{dB}$
30kHz	150kHz		$\pm 0.3\text{dB}$
100kHz	500kHz		$\pm 0.3\text{dB}$
300kHz	1.5MHz		$\pm 0.3\text{dB}$
1MHz	5MHz		$\pm 0.3\text{dB}$
3MHz	10MHz		$\pm 0.4\text{dB}$

MODEL NAME _____

DATE _____

SERIAL NO. _____

Tested by _____

Input attenuator switching error

MS2650/MS2660 Series setting							
Reference Level	ATT	Attenuator setting	Correction factor of attenuator	Marker readout	Error	Deviation	Spec.
-10dBm	50dB	0dB	dB	dBm	dB	dB	±0.3dB
-20dBm	40dB	10dB	dB	dBm	dB	dB	±0.3dB
-30dBm	30dB	20dB	dB	dBm	dB	dB	±0.3dB
-40dBm	20dB	30dB	dB	dBm	dB	dB	±0.3dB
-50dBm	10dB	40dB	dB	dBm	dB	0dB(reference)	0dB(reference)
-60dBm	0dB	50dB	dB	dBm	dB	dB	±0.3dB

Sweep time and Time span accuracy

• Sweep time

MS2650/MS2660 Series setting		Signal generator		
SWEEP TIME	AM Modulation frequency	SWT TIME (measured)	Specification min/max	
50msec	400Hz	sec	38.25msec/51.75msec	
200msec	100Hz	sec	153msec/207msec	
2sec	10Hz	sec	1.53sec/2.07sec	
20sec	1Hz	sec	15.3sec/20.7sec	
200sec	0.1Hz	sec	99sec/261sec	

• Time span accuracy

MS2650/MS2660 Series setting		Signal generator		
Time span	AM Modulation frequency	Time span (measured)	Specification min/max	
20msec	1kHz	sec	17.82msec/18.18msec	
200msec	100Hz	sec	178.2msec/181.8msec	
2sec	10Hz	sec	1.782sec/1.818sec	
20sec	1Hz	sec	17.82sec/18.18sec	
200sec	0.1Hz	sec	178.2sec/181.8sec	

(13/13)

MODEL NAME _____

DATE _____

SERIAL NO. _____

Tested by _____

Tracking generator output level accuracy

Output level (dBm)	Frequency(Hz)							
	100k	1M	10M	50M	100M	1G	2G	3G
0								
-5								
-10								
-20								
-30								
-40								
-50								

Anritsu Service and Sales offices

America

Anritsu Company (ACUS)

685-A Jarvis Drive Morgan Hill, CA
95037-2809, U.S.A.
Phone: +1-408-776-8300
Fax: +1-408-776-1738

Anritsu Company (ACUS-NJ) Dist.5

10 New Maple Avenue, P.O. Box 836
Pine Brook, NJ 07058-0836, U.S.A.
Phone: +1-973-227-8999
Fax: +1-973-575-0092

Anritsu Company (ACUS-Maryland) Dist.6

19630 Club House Road, #710
Gaithersburg, MD20879, U.S.A.
Phone: +1-301-590-0300
Fax: +1-301-216-2893

Anritsu Company (ACUS-Tx) NARO

1155 East Collins Blvd
Richardson, TX 75081, U.S.A.
Phone: +1-972-644-1777
Fax: +1-972-644-3416

Anritsu Electronics Ltd (ACCA)

5A-245 Matheson Blvd. East, Mississauga,
Ontario, L4Z 3C9, Canada
Phone: +1-905-890-7799
Fax: +1-905-890-2290

Anritsu Electronics Ltd (ACCA)

102-215 Stafford Road West Nepean,
Ontario, K2H 9C1, Canada
Phone: +1-613-828-4090
Fax: +1-613-828-5400

Anritsu Electronics Ltd (ACCA)

200-1405 Trans Canada Highway
Dorval, Quebec H9P 2V9, Canada
Phone: +1-514-421-3737
Fax: +1-514-685-9839

Anritsu Electronics Ltd (ACCA-Calgary)

Deerfoot Atrium, Suite 129, 6715-8th Street
N.E., Calgary, AB, T2E 7H7, Canada
Phone: +1-403-275-9855
Fax: +1-403-275-3609

Anritsu Eletrônica Ltd (ACBR)

Praia de Botafogo, 440-Sala 2401
CEP 22250-040, Rio de Janeiro, RJ, Brasil
Phone: +55-21-5276922
Fax: +55-21-537-1456

Anritsu Eletrônica Ltd (ACBR) Sao Paulo Branch Office

Praca Amadeu Amaral 27,
Primera Andar, Conj. 11, 12, 13, 14
Liberdade, Sao Paulo, Estado de
Sao Paulo, CEP : 01327-010, Brasil
Phone: +55-11-283-2511
Fax: +55-11-288-6940

Data Lab S.R.L

Edif. Ayfra, Pdte. Franco y Ayolas
Asuncion, Paraguay
Phone: +595-21-443-046
Fax: +595-21-441+935

Electro-Impex S.A.

P.O. Box 620-1000, San Jose, Costa Rica
Phone: +506-2-31-5701
Fax: +506-2-31-6531

Electronica 2000, S.A. DE C.V.

Bldv. Adolfo Lopez Mateos No.2016, Col.
Tiacoapac, Del. Lopez Mateos, 01010,
Mexico D.F.
Phone: +525-662-8800
Fax: +525-662-5862

Electronic Engineering S.A.

Carretera de Circunvalacion, Sabanilla, Av
Novena, San Jose, Costa Rica
Phone: +506-2-25-8793
Fax: +506-2-25-1286

HDM Elquitecnica Cia. Ltda., Equitronics S.A.

Av. Republica de El Salvador, No.880,
Edificio, Almirante Colon 4to piso,
Quito, Ecuador
Phone: +593-9-704890
Fax: +593-2-48-2627

KRM Ingenieria Socias.

Viamonte 377,7° Piso 1053 Buenos Aires,
Argentina
Phone: +54-1-311-4165
Fax: +54-1-311-2297

SI Ltda.

E. Conchy Y Toro 65, Casilla 51888,
Santiago, Chile
Phone: +56-2-696-7534
Fax: +56-2-696-9665

Radiocom S.A.

Carrera 21 No.85-71, Conmutador
6100077, Santafe de Bogota, Columbia
Phone: +57-1-218-2054
Fax: +57-1-610-3272

Radiocomunicaciones cruz C.A.

Avda La Colina QTA. Elison, URB Colina
De Los Caobos, Caracas, Venezuela
Phone: +58-2-793-2322
Fax: +58-2-793-3429

Sakata Ingenieros S.A.

Av. Canaval Moreyra 840, Lima 27, Peru
Phone: +51-1225-7555
Fax: +51-1224-8148

Suministros Industriales S.A.

Casa 102, Calle 68 Este,
San Francisco, Balboa, Panama
Phone: +507-270-2328
Fax: +507-270-2329

Cabonorte S.A.

Colonia 1900, ESC. 603,
Montevideo, Uruguay
Phone: +598-2-430522
Fax: +598-2-418594

Europe

Anritsu Ltd (ACUK)

200 Capability Green, Luton
Bedfordshire, LU1 3LU, United Kingdom
Phone: +44-1582-433200
Fax: +44-1582-731303

Anritsu Ltd (ACUK-Manchester)

Kansas Avenue, Langworthy Park Salford,
Manchester M5 2GL, United Kingdom
Phone: +44-161-873-8041
Fax: +44-161-873-8040

Anritsu Ltd (ACUK-Bristol)

1230 Aztec West, Almondsbury
Bristol BS12 4SG, United Kingdom
Phone: +44-1454-615252
Fax: +44-1454-618017

Anritsu Ltd (ACUK-Livingston)

Unit 1, Knightsridge Industrial Estate
Tumbull Way, Knightsridge Livingston
EH54 8RB, United Kingdom
Phone: +44-1506-436111
Fax: +44-1506-436112

Anritsu GmbH (ACDE)

Grafenberger Allee 54-56
D-40237 Düsseldorf 1, Germany
Phone: +49-211-96855-0
Fax: +49-211-96855-55

Anritsu GmbH (ACDE-Sales Center South)

An der Steinernen Brücke 1 D-85757
Karlshof, Germany
Phone: +49-8131-3825-0
Fax: +49-8131-3825-95

Anritsu S.A. (ACFR)

9, Avenue du Québec ZA de
Courtaboeuf 91951 Les Ulis Cedex,
France
Phone: +33-1-60-92-15-50
Fax: +33-1-64-46-10-65

**Anritsu S.A. (ACFR)
(Toulouse Office)**

Bureau de Toulouse
Région Centre Sud Ouest
Phone: +33-5-62070484
Fax: +33-5-62070668

**Anritsu S.A. (ACFR)
(Toulon Office)**

Bureau de Toulon
Région Centre Sude Est
Phone: +33-4-94040264
Fax: +33-4-94040265

**Anritsu S.A. (ACFR)
(Rennes Office)**

Bureau de Rennes
Région Ouest
Phone: +33-2-99521214
Fax: +33-2-99521224

Anritsu S.p.A. (ACIT)

Via Elio Vittorini, 129
00144 Roma EUR, Italy
Phone: +39-06-509-9711
Fax: +39-06-502-2425

Anritsu S.p.A (ACIT-Milano)

C.D. Colleoni, Via Paracelso, 420041
AGRATE B.ZA(MI), Italy
Phone: +39-039-65-7021
Fax: +39-039-605-6396

Anritsu AB (ACSE)

BOTVID CENTER
145 84 STOCKHOLM, Sweden
Phone: +46-8-53470700
Fax: +46-8-53470730

**Anritsu AB-Norway Branch
Office (ACNO)**

Leangbukta 40 1370 Asker, Norway
Phone: +47-66-901190
Fax: +47-66-901212

**Anritsu AB-Finland Branch
Office (ACFI)**

Piispanportti 9 FIN-02240 Espoo, Finland
Phone: +358-9-435-522-0
Fax: +358-9-435-522-50

**Anritsu AB-Denmark Branch
Office (ACDK)**

SOHOJ 11, DK-2690 KARLSLUNDE
Denmark
Phone: +45-46160330
Fax: +45-46155299

C.N. Rood B.V.

Cort van der Linddenstraat 11-13, 2288
EV Rijswijk ZH, The Netherlands
Phone: +31-70-3996360
Fax: +31-70-3905740

C.N. Rood SA/NV

Pontbeeklaan 45, 1731 Zellik, Belgium
Phone: +32-2-4668199
Fax: +32-2-4662500

ELSINCO GMBH

h.e. Strelbishte, str. Kotlenski Prohod, bl.
96/6/14, BG-1408 Sofia, Bulgaria
Phone: +359-2-58-61-31
Fax: +359-2-58-16-98

ELSINCO Praha Spol.

Novedvorska 994, CZ 142 21 Praha
4-Branik, Czecho Republic
Phone: +42-2-49-66-89
Fax: +42-2-49-54-83

ELSINCO Budapest KFT

Pannonia utca 8. IV/I.
H-1136 Budapest, Hungary
Phone: +36-1-269-18-50
Fax: +36-1-132-69-27

ELSINCO Polska Sp. Z.O.O

ul. Dziennikarska 6/1, PL 01 605
Warszawa, Poland
Phone: +48-22-39-69-79
Fax: +48-22-39-44-42

ELSINCO Bratislava Spol. s.r.o.

Kudlakova 4, SK 844 15 Bratislava,
Slovakia
Phone: +42-7-784-165
Fax: +42-7-784-454

G'Amungason Co.

Skuilagata 40, 101 Reykjavik, Iceland
Phone: +354-1-677887
Fax: +354-1-625045

GMP S.A.

Av. des Baumettes 19, CH-1020 Renens
1 Lausanne, Switzerland
Phone: +41-21-6348181
Fax: +41-21-6353295

Instrutek Oeriferi A/S

Christiansholmegade DK-8700 Horsens,
Denmark
Phone: +45-75-611100
Fax: +45-75-615658

Kostas Karayannis SA

58, Kapodistriou str., GR-142 35 Nea Ionia,
Athens, Greece
Phone: +30-1-680-0460-4
Fax: +30-1-685-3522

Omnitecnica S.A.

Estrada Alfragide 2700 Amadora, Portugal
Phone: +351-1-471-55-17
Fax: +351-1-471-36-10

Pema Ltd.

Doromiskin, Dundalk, Co. Louth, Ireland
Phone: +353-42-72899
Fax: +353-42-72376

Unitronics S.A.

Plaza Espana 18, Torre de Madrid,
Pl. 12-ofc. 9, 28019 Madrid, Spain
Phone: +34-1-5425204
Fax: +34-1-5591957

Wien CHALL GMBH

Krichbaumgasse 25, 1120 Wien, Austria
Phone: +43-1-811-55140
Fax: +43-1-811-55180

**Asia, Pacific
and Africa**

Anritsu Private Ltd (ACSG)

6, New Industrial Rd., #06-01/02
Hoe Huat Industrial Building
Singapore 536199
Phone: 65-282-2400
Fax: 65-282-2533

Anritsu Company Ltd (ACHK)

Suite 719, 7/F., Chinachem Golden Plaza,
77 Mody Road, Tsimshatsui
East, Kowloon, Hong Kong
Phone: +852-2301-4980
Fax: +852-2301-3545

**Anritsu Company Incorporated
(ACTW)**

6F, 96, Sec. 3, Chien Kou North Rd.
Taipei, Taiwan
Phone: +886-2-2515-6050
Fax: +886-2-2509-5519

**Anritsu Corporation, Ltd (ACKR)
Head Office**

14F Hyunjuk Bldg. 832-41,
Yeoksam-dong, Kangnam-ku,
Seoul, Korea
Phone: +82-2-553-6603
Fax: +82-2-553-6604-5

Anritsu Proprietary Ltd (ACAU)

Unit 3, 170, Forster Rd., Mt. Waverley
Victoria 3149, Australia
Phone: +61-3-9558-8177
Fax: +61-3-9558-8255

Anritsu Proprietary Ltd (ACAU)

Suite 304/2 Rowe Street Eastwood
NSW 2122, Australia
Phone: +61-2-9874-9044
Fax: +61-2-9874-9920